

**WATER SYSTEM ANALYSIS
FOR THE
NAKANO PROJECT
IN THE CITY OF CHULA VISTA**

June 21, 2022



6-21-2022

Prepared by:
Dexter Wilson Engineering, Inc.
2234 Faraday Avenue
Carlsbad, CA 92008
(760) 438-4422

Job No. 648-038

TABLE OF CONTENTS

	<u>PAGE NO.</u>
Introduction.....	1
Purpose of Study and Water System Design Criteria.....	3
Study Area and Existing Water System.....	4
Nakano Project Water Demand.....	5
Water Service Overview.....	6
Available Hydraulic Grade Line.....	7
Private Domestic Water System.....	7
Domestic Water System Pipe Sizing	9
Private Fire Protection System Pipe Sizing	9
Model Development.....	11
Fitting and Valve Losses.....	11
Backflow Assembly Losses.....	11
Hydraulic Grade Line Available	11
Fire Protection System Analysis.....	11
Conclusion and Recommendations	12

APPENDICES

APPENDIX A	CITY OF SAN DIEGO WATER DEPARTMENT GUIDELINES AND DESIGN CRITERIA, CA FIRE CODE EXCERPT, AND EXISTING WATER INFORMATION
APPENDIX B	PRIVATE DOMESTIC WATER BACKGROUND INFORMATION
APPENDIX C	MANUFACTURER’S LITERATURE FOR A REDUCED PRESSURE PRINCIPLE DETECTOR CHECK ASSEMBLY BACKFLOW PREVENTER
APPENDIX D	COMPUTER HYDRAULIC MODEL RUNS PRIVATE FIRE PROTECTION SYSTEM ANALYSIS

LIST OF TABLES

PAGE NO.

TABLE 1	CITY OF SAN DIEGO WATER DEPARTMENT WATER SYSTEM DESIGN CRITERIA.....	3
TABLE 2	NAKANO PROJECT POTABLE WATER DEMAND	5

LIST OF FIGURES

PAGE NO.

FIGURE 1	LOCATION MAP	2
FIGURE 2	HYDRAULIC CONTROL MAP	8
FIGURE 3	EXISTING AND PROPOSED WATER SYSTEM.....	10

DEXTER S. WILSON, P.E.
ANDREW M. OVEN, P.E.
NATALIE J. FRASCHETTI, P.E.
STEVEN J. HENDERSON, P.E.
FERNANDO FREGOSO, P.E.
KATHLEEN L. HEITT, P.E.

June 21, 2022

648-038

Tri Pointe Homes
13400 Sabre Springs Parkway, Suite 200
San Diego, CA 92128

Attention: April Tornillo, P.E., Project Manager

Subject: Water System Analysis for the Nakano Project in the City of Chula Vista

Introduction

This report provides a water system analysis for the Nakano residential project currently in the City of Chula Vista and Otay Water District. The Nakano project is located in the southern portion of the City of Chula Vista. It is situated along Dennery Road immediately east of the Interstate 805 freeway approximately 1,500 feet north of Palm Avenue. See Figure 1 for the location of the project.

The Nakano project is proposing to develop the property with 67 detached condominiums, 84 duplexes and 70 multi-family dwelling units (221 total units) spread across 23.8 gross-acres. The Project does not have direct access to Chula Vista utilities and would need to be served by the City of San Diego. The Project will also simultaneously process to de-annex from the City of Chula Vista and Otay Water District and annex into the City of San Diego.

\\ARTIC\DWG\648038\REPORT\NP_FIGURE-1_LOCMAP.DWG 06--10--21 08:47:16 LAYOUT: 8X11

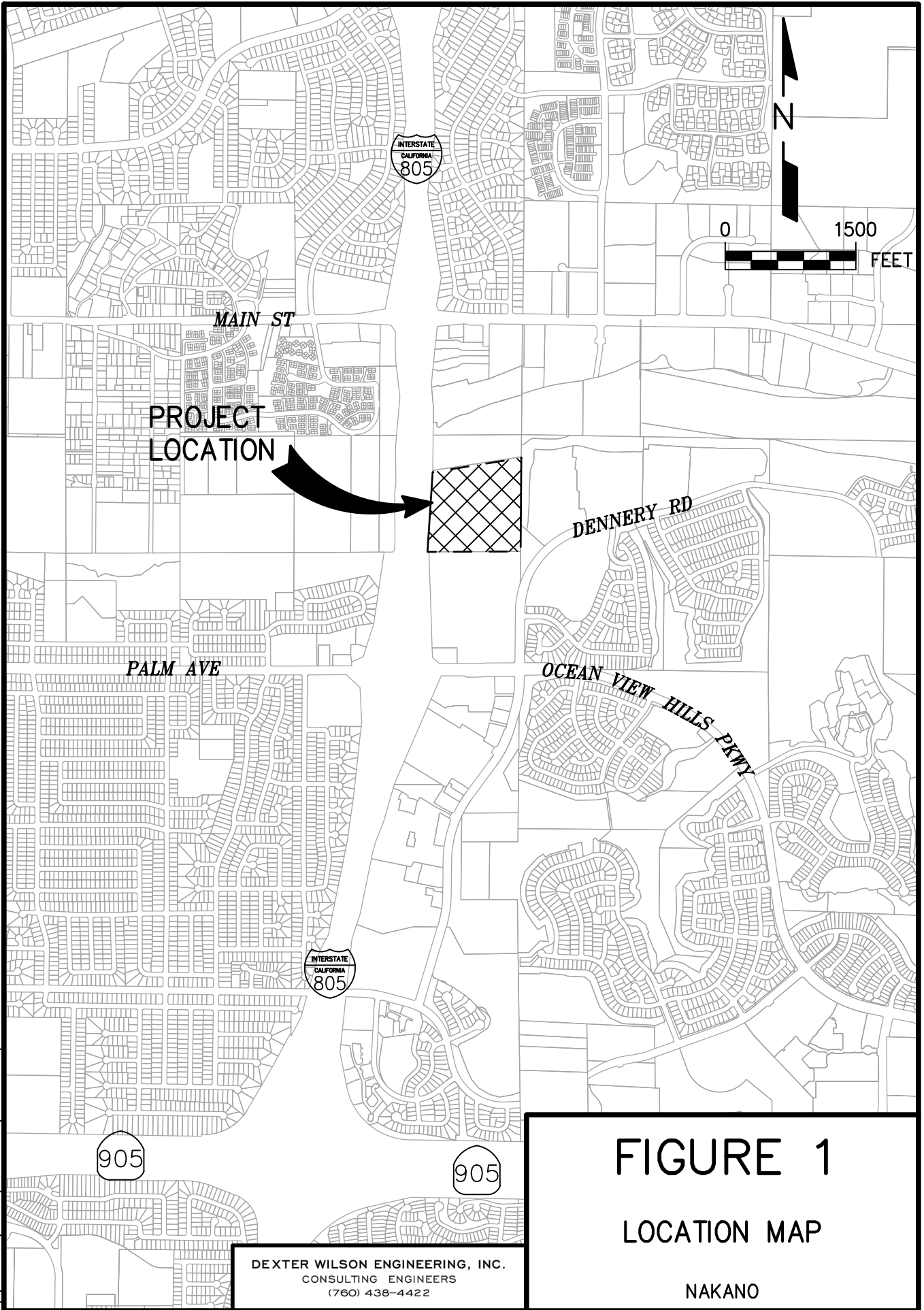

FIGURE 1

LOCATION MAP

DEXTER WILSON ENGINEERING, INC.
CONSULTING ENGINEERS
(760) 438-4422

NAKANO

The Nakano project will receive water service from the City of San Diego Water Department and will be located within the 365 Pressure Zone.

Purpose of Study and Water System Design Criteria

The purpose of this study is to analyze and determine if the existing public water system is able to provide adequate domestic and fire protection service for the Nakano project. This report will address if any offsite (public) City of San Diego water system improvements are needed for the development of the project so that the offsite water system will be in conformance with the City of San Diego Water Department water system design standards. The City of Chula Vista and City of San Diego annexation procedures and ultimate determinations for the Nakano project will have no impact to the water supply and connection points presented in this study.

A summary of the City of San Diego Water Department design criteria from Book 2 is presented as Table 1.

TABLE 1 CITY OF SAN DIEGO WATER DEPARTMENT WATER SYSTEM DESIGN CRITERIA	
Criteria	Design Requirement
Single-Family Residential (up to 4-plex) Fire Flow	1,500 gpm
Condominiums and Apartments Residential Fire Flow	3,000 gpm
Minimum Static Pressure	65 psi
Maximum Static Pressure	120 psi
Maximum Pressure Drop – Domestic Pressure	25 psi
Minimum Pressure – Domestic Pressure	40 psi
Minimum Pressure – Max Day plus Fire	20 psi
Maximum Pipeline Velocity (Fire Flow)	15 fps
Maximum Pipeline Velocity (Normal Operating Conditions)	5 fps

Water service internal within the Nakano project will consist of two separate private water systems; one will be for private domestic water service and the other will be for private fire protection service. The domestic water system is sized in accordance with the California Plumbing Code 2019.

The fire protection component of the water system is designed based on the required fire flow for the project as dictated for residential land use. The City of San Diego Water Department requires a 1,500-gpm fire flow for single family residential and a 3,000-gpm fire flow for multi-family residential (> 4-plex). The California Fire Code also establishes fire flow requirements. The fire code takes into account building area and construction type. The largest building proposed for the project site is not finalized/established yet at time of this report. The worst-case fire flow requirement expected per the 2019 California Fire Code is 4,000 gpm. After the reduction of 25% for an approved fire sprinkler system stated by the City of Chula Vista, the expected worst-case fire flow requirement for the project site would be 3,000 gpm.

Appendix A presents the City of San Diego Water Department guidelines and design criteria as well as the excerpt from the 2019 California Fire Code pertaining to fire flow requirements.

Additionally, the private fire protection system is designed to provide a minimum residual pressure greater than 20 psi at any location within the private fire protection water system under a fire flow demand.

Study Area and Existing Water System

The study area for this report is the boundary of the Nakano project and the water system surrounding the project. The extent of the existing water system which was incorporated into the analysis of the project site was based on the existing 365 Zone distribution system that serves the area.

The Nakano project is within the City of Chula Vista and will obtain water service from the City of San Diego's public water system. The nearest existing public water line in the vicinity

of the Nakano project is a 12-inch diameter water line in Dennery Road. There are 42-inch diameter transmission lines in Dennery Road as well, however, they are in the 490 Zone.

Nakano Project Water Demand

The water demands were developed in accordance with the City of San Diego Water Department Design Guidelines and Standards. Residential water demand is estimated based on density and a unit water demand of 150 gpd/person. The Nakano project proposes 221 residential units over 19.04 net acres equaling 11.6 units per acre. Table 2-1 in the City of San Diego Water Department Design Guidelines and Standards, attached as Appendix A, indicates that 11.6 units per acre falls in the range of 3.5 persons per dwelling unit.

A dwelling unit density of 3.5 persons per dwelling unit and a unit water demand of 150 gpd/person results in a water demand rate of 525 gpd per dwelling unit at the project.

Table 2 presents the projected potable water demand for the Nakano project.

TABLE 2 NAKANO PROJECT POTABLE WATER DEMAND			
Land Use	Quantity	Demand Factor	Average Water Use, gpd
Residential (11.6 DUs/net acre)	221 Units	525 gpd/DU	116,025
TOTAL			116,025 = 80.6 gpm

From the City of San Diego Water Department Guidelines and Standards, Figure 2-2, the maximum day demand to average annual demand ratio is approximately 1.7 based on the RS residential peaking curve, resulting in an estimated maximum day demand of 197,243 gpd (137 gpm).

From the City of San Diego Water Department Guidelines and Standards, Figure 2-1, the peak hour demand to average annual demand ratio is approximately 3.1 based on the RS residential peaking curve, resulting in an estimated peak hour demand of 359,678 gpd (250 gpm).

Appendix A of this report presents the backup data for determining these peaking factors.

Water Service Overview

Water service to the Nakano project will be provided by constructing a new 12-inch diameter 365 Zone public water line in Dennery Road from the existing water regulating station at Sand Star Way up to the project frontage/entrance driveway. This new 12-inch diameter public water line will need to tie in to the existing 12-inch diameter public water line east of the supply lateral from the existing water regulating station at Sand Star Way.

The range of pad elevations on the project, 111 to 119 feet, results in expected maximum static pressures at the street to be between 107 psi and 110 psi.

The private domestic water system for Nakano will consist of installing a new domestic service lateral and setting a new domestic meter and backflow preventer for the lot. Sizing of the private domestic water system will be discussed in more detail later in this report.

The private fire protection system will consist of two 8-inch diameter fire service laterals extending off of the new and existing 12-inch diameter public water lines in Dennery Road. An 8-inch reduced pressure principle detector check assembly will be installed at the project boundary at both connections to the public system, and internal to the project there will be 8-inch private fire protection piping to provide service to the seven onsite private fire hydrants.

Fire sprinkler water lines and laterals, which are expected to be connected to the private fire protection system and will supply the individual residence fire sprinkler system, shall be sized by the fire sprinkler system designer employed for the Nakano project and are outside the scope of work for this report.

Available Hydraulic Grade Line

The available hydraulic grade line (HGL) in the vicinity of the Nakano project was obtained from the City of San Diego Public Utilities Department Water Field Book. The pertinent sheets from the Water Field Book are included in Appendix A of this report. According to the Water Field Book, the two existing water regulating stations feeding the 365 Zone consist of 10-inch pressure reducing valves which corresponds to a maximum flow of 4,900 gpm each. The City of San Diego Water Department typically sets the larger valve approximately 10 psi less than the smaller valve at water regulating stations which would equate to an available HGL of 341 feet at the existing water regulating stations in the project vicinity. A hydraulic control map illustrating the pressure zone boundaries in the area is presented as Figure 2.

Private Domestic Water System

Private domestic water service to the Nakano project will be provided through a master meter. This domestic water meter is preliminarily sized based on the California Plumbing Code. The California Plumbing Code uses Water Fixture Units as a basis for determining maximum domestic flow. The preliminary sizing of the project's master water meters and private domestic water system is summarized below as well as in Appendix B.

For the Nakano project, the California Plumbing Code estimates the maximum domestic flow to be approximately 820 gpm based on a conservative count of Water Fixture Units based on the proposed residential product types. The city of San Diego Water Department uses 80 percent of the AWWA meter rating as their maximum allowable flow rate. A 6-inch meter has an AWWA rated capacity of 1,350 gpm, which means the maximum flow rate allowed by the city of San Diego for a 6-inch meter is 1,080 gpm. As this is still higher than the estimated demand for Nakano of approximately 820 gpm, a single 6-inch meter is sufficient for Nakano.

The City of San Diego Water Department, however, also has a policy of installing two parallel meters whenever the peak flow rate exceeds the capacity of a 2-inch meter. Thus, for this project which needs a single 6-inch meter, the Water Department will instead install two 4-inch meters in parallel. Although there will be two meters, there will only be a single 6-inch public water service lateral that will then split into the two 4-inch meters with each meter being followed by a 4-inch reduced pressure principle backflow preventer.

\\ARTIC\DWG\648038\REPORT\NP_WTR_FIGURE-2_HCM.DWG 2/9/2022 1:58:30 PM LAYOUT:11x17 USER:SirJay

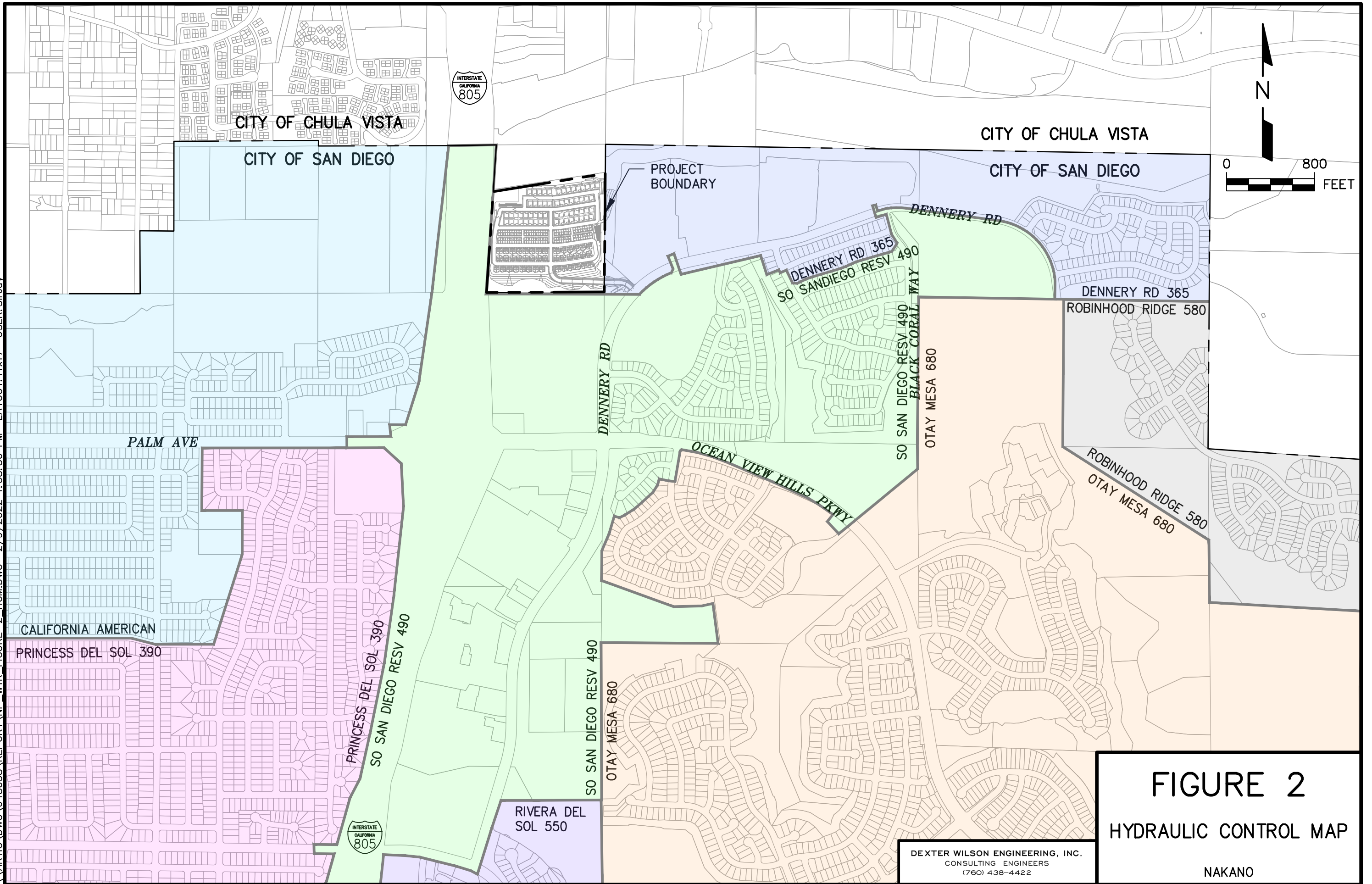

FIGURE 2
HYDRAULIC CONTROL MAP

DEXTER WILSON ENGINEERING, INC.
 CONSULTING ENGINEERS
 (760) 438-4422

NAKANO

The proposed 6-inch domestic water service lateral will be connected to the proposed 12-inch 365 Zone water line in Dennery Road.

Domestic Water System Pipe Sizing. The private domestic water system distribution piping for the Nakano project has been preliminarily sized in accordance with the Uniform Plumbing Code and the Installation Standard for PVC Cold Water Building Supply and Yard Piping (IAPMO IS 8-2006). The Installation Standard requires that the maximum pipeline velocity be limited to eight feet per second (8 fps).

Figure 3 presents a graphic of the recommended private domestic water system for the project. Individual residence supply piping is to be sized to match the plumbing plans for the size of the domestic water entering the single buildings.

The domestic water line sizes shown on Figure 3 are the minimum recommended pipe sizes that comply with the California Plumbing Code and will supply adequate flow and pressure within the Nakano project. The line sizes may be increased for uniformity or ease of construction.

Private Fire Protection System Pipe Sizing

All fire hydrants within the Nakano project will be connected to a private fire protection water system which will be independent of any other water system. The private fire protection system for Nakano will have one connection to the new 12-inch public water line and one connection to the existing 12-inch public water line in Dennery Road.

The private fire protection system was sized based on the required fire flow for the project and taking into consideration the proposed piping configuration. In order to establish the required fire protection system pipe sizing, a water system computer model was generated for the project's fire protection system piping. Fire flow scenarios were modeled which provided data upon which the recommended pipe sizing is based.

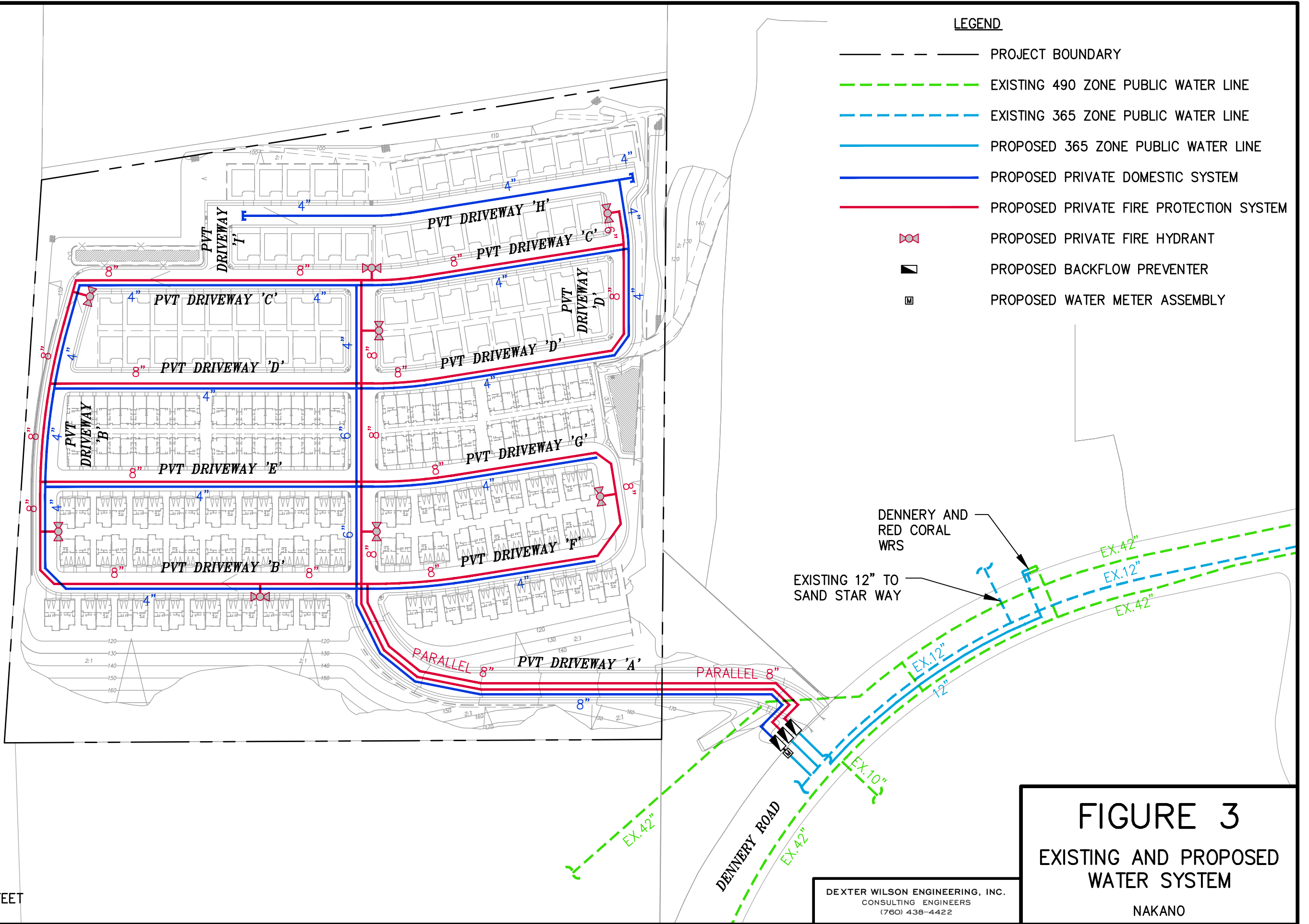
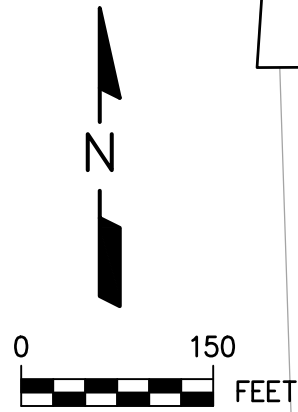

LEGEND

- PROJECT BOUNDARY
- - - - - EXISTING 490 ZONE PUBLIC WATER LINE
- - - - - EXISTING 365 ZONE PUBLIC WATER LINE
- PROPOSED 365 ZONE PUBLIC WATER LINE
- PROPOSED PRIVATE DOMESTIC SYSTEM
- PROPOSED PRIVATE FIRE PROTECTION SYSTEM
- ⊗ PROPOSED PRIVATE FIRE HYDRANT
- ▴ PROPOSED BACKFLOW PREVENTER
- ▣ PROPOSED WATER METER ASSEMBLY

DENNERY AND RED CORAL WRS

EXISTING 12" TO SAND STAR WAY

FIGURE 3
EXISTING AND PROPOSED WATER SYSTEM
 NAKANO

DEXTER WILSON ENGINEERING, INC.
 CONSULTING ENGINEERS
 (760) 438-4422

Model Development. Analysis using the KYPIPE computer software program developed by the University of Kentucky determined residual pressures throughout the fire protection system. This computer software utilizes the Hazen-Williams equation for determining headloss in pipes. The Hazen-Williams “C” value used for all pipe sizes in our analysis is 120.

Fitting and Valve Losses. To simulate minor losses through pipe fittings and valves, “K” values were added to the pipe segments and included in the hydraulic model.

Backflow Assembly Losses. The pressure losses through the reduced pressure principle detector check assembly devices were modeled as losses inputting a loss curve which simulates the expected pressure loss through these devices. Appendix C presents a candidate reduced pressure principle detector check assembly backflow preventer device. The manufacturer’s literature includes charts which show pressure loss through the backflow preventer as a function of flow. These charts were used to approximate the pressure losses which were reflected in the computer modeling.

Hydraulic Grade Line Available. The private fire protection system was modeled with an estimated hydraulic grade line at each of the existing water regulating stations of 341 feet. These locations are along Dennery Road at Sand Star Way and Black Coral Way respectively. This hydraulic grade line was obtained using the City of San Diego Public Utilities Department Water Field Book as described earlier in this report.

The private fire protection system has been designed to provide a minimum residual pressure greater than 20 psi under a fire flow scenario within the Nakano project.

Fire Protection System Analysis. Appendix D presents the computer modeling results for the private fire protection system. Exhibit A at the end of Appendix D shows the Node and Pipe Diagram for the private fire protection system. The fire flow requirements of 1,500 gpm and 3,000 gpm was modeled at all pertinent fire hydrant locations.

The existing public water system is not able to supply the required fire hydrant flow due to lack of redundancy. The recommendation is to construct a new parallel 12-inch diameter water main in Dennery Road from the existing water regulating station at Sand Star Way to

the project entrance driveway. This parallel water main will enable the fire flow requirement for the Nakano project to be met in spite of potential pipe breaks. As a conservative approach, this proposed parallel 12-inch diameter water line was not included in the hydraulic model.

With the proposed 12-inch public water main improvement in Dennerly Road, the fire flow requirement is being met with greater than 20 psi residual pressure at all locations within the project. Minimum residual pressures are greater than 43 psi under all fire flow scenarios.

The private fire protection system will be connected to the new 12-inch public water line and to the existing 12-inch public water line in Dennerly Road as shown in Figure 3 and Exhibit A. Each of the two connections includes an 8-inch lateral and an 8-inch reduced pressure principle detector check assembly in accordance with the City of San Diego Water Department standards and the City of Chula Vista Backflow Prevention Department requirements (if applicable).

The City of Chula Vista Fire Department requirements for fire hydrants, fire hydrant locations, fire department connection (FDC) locations, post indicator valves (PIV), and other standard details can be found at:

<http://www.chulavistaca.gov/departments/fire-department/about-cvfd/fire-prevention/forms-details>

Conclusions and Recommendations

The following conclusions and recommendations are summarized based upon the water system analysis performed for the Nakano project.

1. Water service to the project will be provided by the City of San Diego Water Department public water system.
2. The existing City of San Diego Water Department public water system does front the proposed project with an existing 12-inch diameter 365 Zone water line. The development project will have to construct a parallel 12-inch diameter 365 Zone water

line in Dennery Road from the existing water regulating station at Sand Star Way to the project entrance driveway. The length of 12-inch public water main extension is approximately 400 linear feet.

3. Finished floor elevations within the project range from approximately 111 to 119 feet resulting in a range of maximum static water pressures in the street of 107 to 110 psi.
4. Domestic and fire protection service to the project shall be supplied by two independent private water systems.
5. Private domestic service for the Nakano project will be supplied by two 4-inch domestic water meters.
6. Each 4-inch domestic meter will be followed by a 4-inch reduced pressure principle backflow preventer.
7. The Water Fixture Units for the project must be further evaluated and confirmed during the improvement plan review stage of this project.
8. Figure 3 presented in this report provides the recommended distribution pipe sizes for the private domestic water system and fire protection system pipeline sizes and layout.
9. The fire flow available to the project site meets the 1,500 gpm and 3,000 gpm fire flow requirement.
10. Private fire protection service for the Nakano project will be supplied by two 8-inch lateral connections to the public system. Internal to the project the private fire protection system will consist of 8-inch piping.
11. The 8-inch private fire protection system connections to the public main shall each include an 8-inch reduced pressure principle detector check assembly backflow preventer in accordance with City of San Diego Water Department standards and the City of Chula Vista Backflow Prevention Department requirements (if applicable).

12. Fire sprinkler water lines and laterals which will supply the individual dwelling unit fire sprinkler systems shall be sized by the fire sprinkler designer employed for the Nakano project and are not included in the scope of this report.
13. The public water system shall be designed and constructed in accordance with the guidelines, standards, and approved materials of the City of San Diego Water Department.
14. This report presents the sizing and a general schematic layout of the proposed private domestic and private fire protection water systems. The design engineer for these systems should incorporate valves, fittings, and appurtenances as needed for proper installation and long-term operation of the private water systems.
15. If PVC pipe is used for the private water lines within the project, we recommend pipes 4-inch through 12-inch diameter to be AWWA C900, DR-14 (Class 305) for private fire protection system piping, and AWWA C900, DR-18 (Class 235) for private domestic system piping. Pipes smaller than 4-inch in diameter should be solvent welded Schedule 40 PVC; as an alternative, copper piping may be used. The 12-inch public water main improvement in Dennery Road is recommended to be 12-inch PVC per AWWA C900 DR-18.

Thank you for the opportunity to assist you with the water system planning for this project. If you have any questions regarding the information presented in this report, please do not hesitate to call.

Dexter Wilson Engineering, Inc.



Steven Henderson, P.E.

SH:ah

Attachments

APPENDIX A

**CITY OF SAN DIEGO WATER DEPARTMENT
GUIDELINES AND DESIGN CRITERIA, CA FIRE CODE EXCERPT, AND
EXISTING WATER INFORMATION**

WATER DEMANDS AND SERVICE CRITERIA

2.1 General

This chapter outlines planning procedures to estimate water demands and fire flows. Water system service requirements are also defined in terms of water pressure and reservoir storage.

2.2 Service Area

The DESIGN CONSULTANT defines the project's service area and identifies the pressure zones in which it is located. The Senior Civil Engineer in charge of either Water Planning or new development approves the service area boundaries.

2.3 Land Use and Residential Population

The DESIGN CONSULTANT develops present and future land use maps for the service area to define the following land use categories: residential (by zone in accordance with **Table 2-1**), central business district, commercial and institutional, parks, hospitals, hotels, industrial, office, and schools.

The DESIGN CONSULTANT estimates the residential population in the service area based on present and future allowable land use. Unless more accurate population density estimates are available, the residential population in the service area is estimated based on the figures presented in **Table 2-1**.

Table 2-1
Residential Population Density

Zone	Dwelling Unit Density (dwelling unit/ net acre)	Unit Density (persons/ dwelling unit)	Population Density (persons/ net acre)
AR-1-1	0.1	3.5	0.4
AR-1-1	0.2	3.5	0.7
AR-1-2	1	3.5	3.5
RS-1-1/RS-1-8	1	3.5	3.5
RS-1-2/RS-1-9	2	3.5	7.0
RS-1-4/RS-1-11	4	3.5	14

Zone	Dwelling Unit Density (dwelling unit/ net acre)	Unit Density (persons/ dwelling unit)	Population Density (persons/ net acre)
RS-1-7/RS-1-14	9	3.5	32
RM-1-1	14	3.2	45
RM-2-5	29	3.0	87
RM-3-7	43	2.6	112
RM-3-9	73	2.2	161
RM-4-10	109	1.8	196
RM-4-11	218	1.5	327

Dwelling unit density in **Table 2-1** is based on net area. The net area is measured in acres, and is 80% of the gross area for each residential zone.

2.4 Average Annual Water Demands

For most projects, average annual water demands are determined based on the unit water demand criteria presented in **Table 2-2**.

Table 2-2
Unit Water Demands

Land Use Category	Unit Water Demand
Residential	150 gallons/person-day
Central Business District	6000 gallons/net acre-day
Commercial and Institutional	5000 gallons/net acre-day
Fully Landscaped Park	4000 gallons/net acre-day
Hospitals	22500 gallons/net acre-day
Hotels	6555 gallons/net acre-day
Industrial	6250 gallons/net acre-day
Office	5730 gallons/net acre-day
Schools	4680 gallons/net acre-day

Average annual water demands are calculated as the sum of: (1) the residential water demand, and (2) other water demands for each land use category as follows:

$$\text{Residential Water Demand (gallons/day)} = \text{Residential Population} \times 150 \text{ gallons/person-day}$$

Chapter 2: Water Demands and Service Criteria

Other Water Demand (gallons/day) = Land Use Area by Category (net acres) x Unit Water Demand for Each Land Use Category (gallons/net acre-day)

Average Annual Water Demand (gallons/day) = Residential Water Demand + Other Water Demands

On some projects, particularly large residential developments, using the unit water demands in **Table 2-2** may generate unrealistically high estimates of water requirements. For these large projects, the DESIGN CONSULTANT or developer may request that the Senior Civil Engineer consider an alternative approach, making use of the City's water demand distribution data developed for macroscale planning purposes. Similarly, the Senior Civil Engineer may also consider alternative unit water demand estimates for specific land use types where such estimates are based on detailed demand evaluations. Recent projects of similar size, nearby location and similar character may be used for comparative demand analysis.

2.5 Peak Water Demands

Unless the project involves a large development that calls for an alternative approach, peak hour and maximum day water demands are estimated using the peaking factors presented in **Figures 2-1 and 2-2**. Peaking day factors correspond to the zones identified in the Public Utilities Department [Water System HGL Zones](#).

Peak water demands are estimated as follows:

Peak Hour Demand = Average Annual Water Demand * Peak Day Factor * 1.5

Maximum Day Demand = Average Annual Water Demand * Peak Day Factor

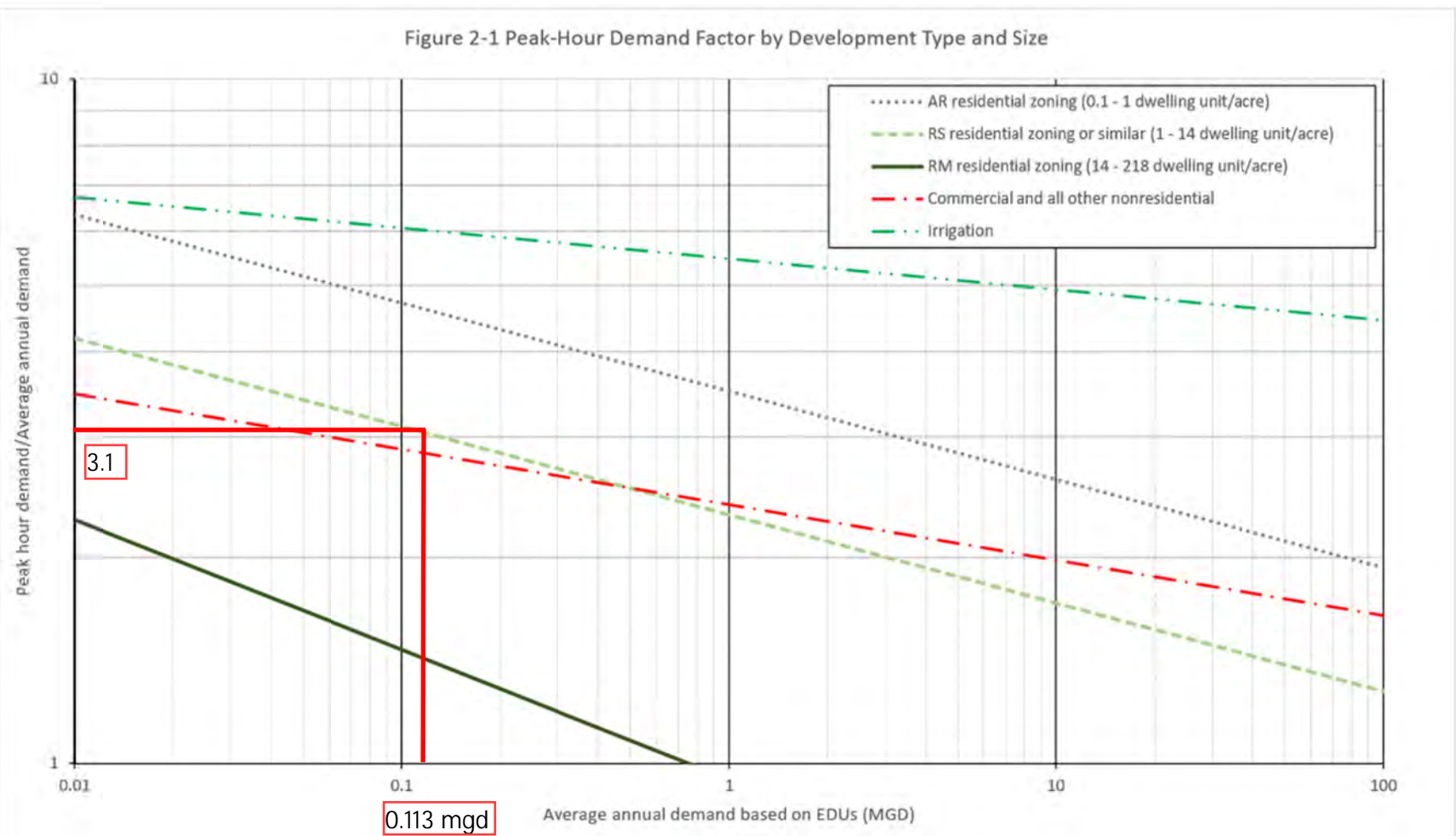

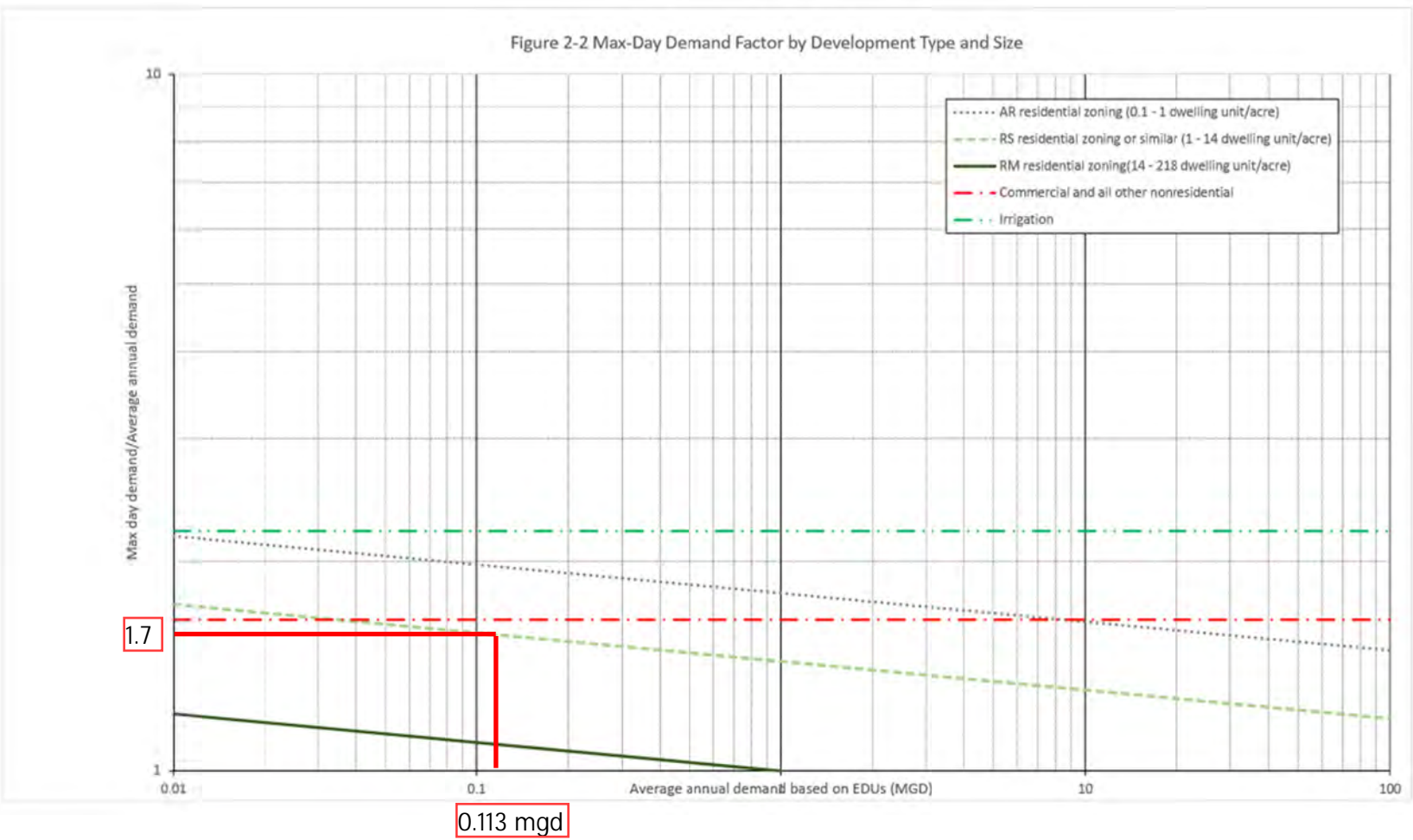

2.6 Fire Demands

The DESIGN CONSULTANT shall use the minimum required fire demands for design shown in **Table 2-3**. The fire flow duration for planning purposes is at least five hours. Note that the values in **Table 2-3** are the minimum design criteria for public infrastructure. Privately owned facilities shall follow the guidelines described in Appendix B of the California Fire Code (CFC).

Table 2-3
Fire Demands for Design Purposes

Development Type	Fire Demand (gpm)
Single family residential up to Fourplexes	1,500
Condominiums and apartments	3,000
Commercial	4,000
Industrial	6,000

Should application of the CFC Appendix B result in figures lower than those shown in **Table 2-3**, the firm or Civil Engineer, in consultation with the fire department, CIP City Project Manager may approve the CFC figures on a case-by-case basis following submittal of supporting calculations. In no case shall the approved fire flow rate and flow duration be less than the flow rate and duration values required by Appendix B of the CFC based on the anticipated or proposed type of building construction and total building floor area.

The required fire demand must be supplied from public and private on-site fire hydrants located as required by CFC Appendix C.

2.7 Pressure Criteria

2.7.1 Design Pressures

Water systems must be designed to provide the minimum residual pressures under:

- Maximum day demands plus fire demand conditions, or
- Peak hour demand conditions.

In analyzing the supply to a pressure zone, the minimum hydraulic grade line elevation available from the water source is used, a level that typically occurs during dry weather conditions. A water supply source is defined as a treatment plant clearwell, flow control facility, pump station, pressure regulating station or reservoir. Supply sources occur at discrete points in a system of

Chapter 2: Water Demands and Service Criteria

water mains and control both flow and pressure at the supply point. Water mains are not supply sources but rather conveyance facilities. The maximum static pressure in gravity systems is determined from reservoir overflow elevations and/or the discharge control setting on pressure reducing valves, whichever is greater. The maximum static pressure in pumped systems is determined from reservoir overflow elevations or pump shutoff levels, whichever is greater. There are two important pressure criteria used in water system design: Domestic Pressure and Fire Pressure. For systems supplying only domestic demand, only the Domestic Pressure criteria will apply. Similarly, for systems providing only fire demand, only the Fire Pressure criteria will apply. Systems supplying both types of demand, both criteria will apply and must be independently checked.

2.7.2 Domestic Pressure Criteria

The domestic pressure criteria for water system design are shown in **Figure 2-3**. Every water main in each pressure zone must be capable of supplying a minimum static pressure of 65 psi. Domestic pressures must fall no more than 25 psi below the static pressure, and residual water main pressure must be at least 40 psi. Domestic pressures are determined in the distribution system pipelines, excluding losses through service connections and building plumbing, and are measured relative to adjacent building pad elevations.

When analyzing a system with one source of supply out of service, domestic pressures may fall more than 25 psi below static pressure, but the domestic pressure shall not fall below 40 psi.

2.7.3 Pressure Requirements During Fires

For the simulation of fire conditions, a minimum operating pressure of 20 psi is required at the fire hydrant locations.. The residual pressure is determined given the fire demand among one or more hydrants and with the simultaneous water consumption occurring at the maximum day demand. The hydrants considered in this simulation must be sufficiently near to the fire location to be classified as “available” to that location as defined by the California Fire Code.

For water systems with available storage, the residual pressures in the distribution system during a fire are maintained given the following conditions:

- The water level in the storage facility at the time of the fire is at or near the minimum operating level
- The prescribed fire duration set by the California Fire Code, occurring under maximum day conditions.

2.8 System Reliability

Water systems must be designed to meet the operating pressure criteria with one critical source

Chapter 2: Water Demands and Service Criteria

out of service. Water mains must be designed so that no more than one, average-sized city block (approximately 30 homes) is out of service at any time, and no more than two fire hydrants (excluding fire services) are on a dead end or are out of service at any time. These provisions do not apply under earthquake conditions.

Water mains serving more than two hydrants or more than 30 homes must be looped, fed from two sources, or provided with a reservoir of sufficient capacity to supply the emergency needs (contingency and fire storage) as described below in **subsection 2.9**.

All water mains relied upon for looping and source redundancy shall be in separate streets. Dual mains in the same street or alignment require the DESIGN ENGINEER to prepare a request for deviation using the format of ATTACHMENT 1, which is included as a part of this document. Where dual mains are relied upon for looping or source redundancy, the mains shall be spaced at least 10 feet apart from outer edge to outer edge.

For City CIP work in already-built-out areas, where looping of mains or connection to two sources of supply is not feasible, water mains may be constructed require the DESIGN ENGINEER to prepare a request for deviation using the format of ATTACHMENT 1, which is included as a part of this document. Additional design considerations shall be made to minimize the chance of pipe breakage, such as use of a higher class of pipe.

TABLE B105.1(1)
REQUIRED FIRE FLOW FOR ONE- AND TWO-FAMILY DWELLINGS, GROUP R-3 AND R-4 BUILDINGS AND TOWNHOUSES

FIRE-FLOW CALCULATION AREA (square feet)	AUTOMATIC SPRINKLER SYSTEM (Design Standard)	MINIMUM FIRE FLOW (gallons per minute)	FLOW DURATION (hours)
0-3,600	No automatic sprinkler system	1,000	1
3,601 and greater	No automatic sprinkler system	Value in Table B105.1(2)	Duration in Table B105.1(2) at the required fire-flow rate
0-3,600	Section 903.3.1.3 of the <i>California Fire Code</i> or Section 313.3 of the <i>California Residential Code</i>	500	1/2
3,601 and greater	Section 903.3.1.3 of the <i>California Fire Code</i> or Section 313.3 of the <i>California Residential Code</i>	1/2 value in Table B105.1(2)	1

For SI: 1 square foot = 0.0929 m², 1 gallon per minute = 3.785 L/m.

TABLE B105.1(2)
REFERENCE TABLE FOR TABLES B105.1(1) AND B105.2

FIRE-FLOW CALCULATION AREA (square feet)					FIRE FLOW (gallons per minute) ^b	FLOW DURATION (hours)
Type IA and IB ^a	Type IIA and IIIA ^a	Type IV and V-A ^a	Type IIB and IIIB ^a	Type V-B ^a		
0-22,700	0-12,700	0-8,200	0-5,900	0-3,600	1,500	2
22,701-30,200	12,701-17,000	8,201-10,900	5,901-7,900	3,601-4,800	1,750	
30,201-38,700	17,001-21,800	10,901-12,900	7,901-9,800	4,801-6,200	2,000	
38,701-48,300	21,801-24,200	12,901-17,400	9,801-12,600	6,201-7,700	2,250	
48,301-59,000	24,201-33,200	17,401-21,300	12,601-15,400	7,701-9,400	2,500	
59,001-70,900	33,201-39,700	21,301-25,500	15,401-18,400	9,401-11,300	2,750	3
70,901-83,700	39,701-47,100	25,501-30,100	18,401-21,800	11,301-13,400	3,000	
83,701-97,700	47,101-54,900	30,101-35,200	21,801-25,900	13,401-15,600	3,250	
97,701-112,700	54,901-63,400	35,201-40,600	25,901-29,300	15,601-18,000	3,500	4
112,701-128,700	63,401-72,400	40,601-46,400	29,301-33,500	18,001-20,600	3,750	
128,701-145,900	72,401-82,100	46,401-52,500	33,501-37,900	20,601-23,300	4,000	
145,901-164,200	82,101-92,400	52,501-59,100	37,901-42,700	23,301-26,300	4,250	
164,201-183,400	92,401-103,100	59,101-66,000	42,701-47,700	26,301-29,300	4,500	
183,401-203,700	103,101-114,600	66,001-73,300	47,701-53,000	29,301-32,600	4,750	
203,701-225,200	114,601-126,700	73,301-81,100	53,001-58,600	32,601-36,000	5,000	
225,201-247,700	126,701-139,400	81,101-89,200	58,601-65,400	36,001-39,600	5,250	
247,701-271,200	139,401-152,600	89,201-97,700	65,401-70,600	39,601-43,400	5,500	
271,201-295,900	152,601-166,500	97,701-106,500	70,601-77,000	43,401-47,400	5,750	
295,901-Greater	166,501-Greater	106,501-115,800	77,001-83,700	47,401-51,500	6,000	
—	—	115,801-125,500	83,701-90,600	51,501-55,700	6,250	
—	—	125,501-135,500	90,601-97,900	55,701-60,200	6,500	
—	—	135,501-145,800	97,901-106,800	60,201-64,800	6,750	
—	—	145,801-156,700	106,801-113,200	64,801-69,600	7,000	
—	—	156,701-167,900	113,201-121,300	69,601-74,600	7,250	
—	—	167,901-179,400	121,301-129,600	74,601-79,800	7,500	
—	—	179,401-191,400	129,601-138,300	79,801-85,100	7,750	
—	—	191,401-Greater	138,301-Greater	85,101-Greater	8,000	

For SI: 1 square foot = 0.0929 m², 1 gallon per minute = 3.785 L/m, 1 pound per square inch = 6.895 kPa.

a. Types of construction are based on the *California Building Code*.

b. Measured at 20 psi residual pressure.

Water Reference Data

VALVES

MAP ID	SIZE	TYPE	CLSD RED	BP SIZE	VALVE TURNS	GR NO	DTL LTR	LOCATION
137	42"	BFV				6	A	S DENNERY W RED CORAL
138	42"	BFV				6	A	S DENNERY W RED CORAL
147	42"	BFV				6	B	S DENNERY W RED CORAL
150	42"	BFV				6	C	S DENNERY W ISLAND BREEZE
154	42"	BFV				6	D	S DENNERY E ISLAND BREEZE
156	42"	BFV				6	D	DENNERY & E ISLAND BREEZE
235	42"	BFV				6	D	N ISLAND BREEZE LN ON DENNERY RD
236	36"	BFV				6	D	N ISLAND BREEZE LN ON DENNERY RD
250	42"	BFV				6	A	S DENNERY W RED CORAL
251	36"	BFV				6	A	S DENNERY W RED CORAL
275	30"	BFV				6		
278	30"	BFV				3		

REGULATORS

MAP ID	SIZE	TYPE	GR NO	DTL LTR	LOCATION	HI PSI	LOW PSI	HGL ZONE FROM	HGL ZONE TO	VALVE ELEV
164	10"	PRV	6	B	DENNERY & RED CORAL WRS			490 SO SAN DIEGO RESV	365 DENNERY RD	165.72
165	4"	RLF	6	B	DENNERY & RED CORAL WRS			490 SO SAN DIEGO RESV	365 DENNERY RD	
166	4"	PRV	6	B	DENNERY & RED CORAL WRS			490 SO SAN DIEGO RESV	365 DENNERY RD	165.72

THIS MAP/DATA IS PROVIDED WITHOUT WARRANTY OF ANY KIND, EITHER EXPRESS OR IMPLIED, INCLUDING BUT NOT LIMITED TO, THE IMPLIED WARRANTIES OF MERCHANTABILITY AND FITNESS FOR A PARTICULAR PURPOSE. Note: This product may contain information from the SANDAG Regional Information System which cannot be reproduced without the written permission of SANDAG. This product may contain information reproduced with permission granted by RAND MCNALLY & COMPANY® to SanGIS. This map is copyrighted by RAND MCNALLY & COMPANY®. It is unlawful to copy or reproduce all or any part thereof, whether for personal use or resale, without the prior, written permission of RAND MCNALLY & COMPANY®.

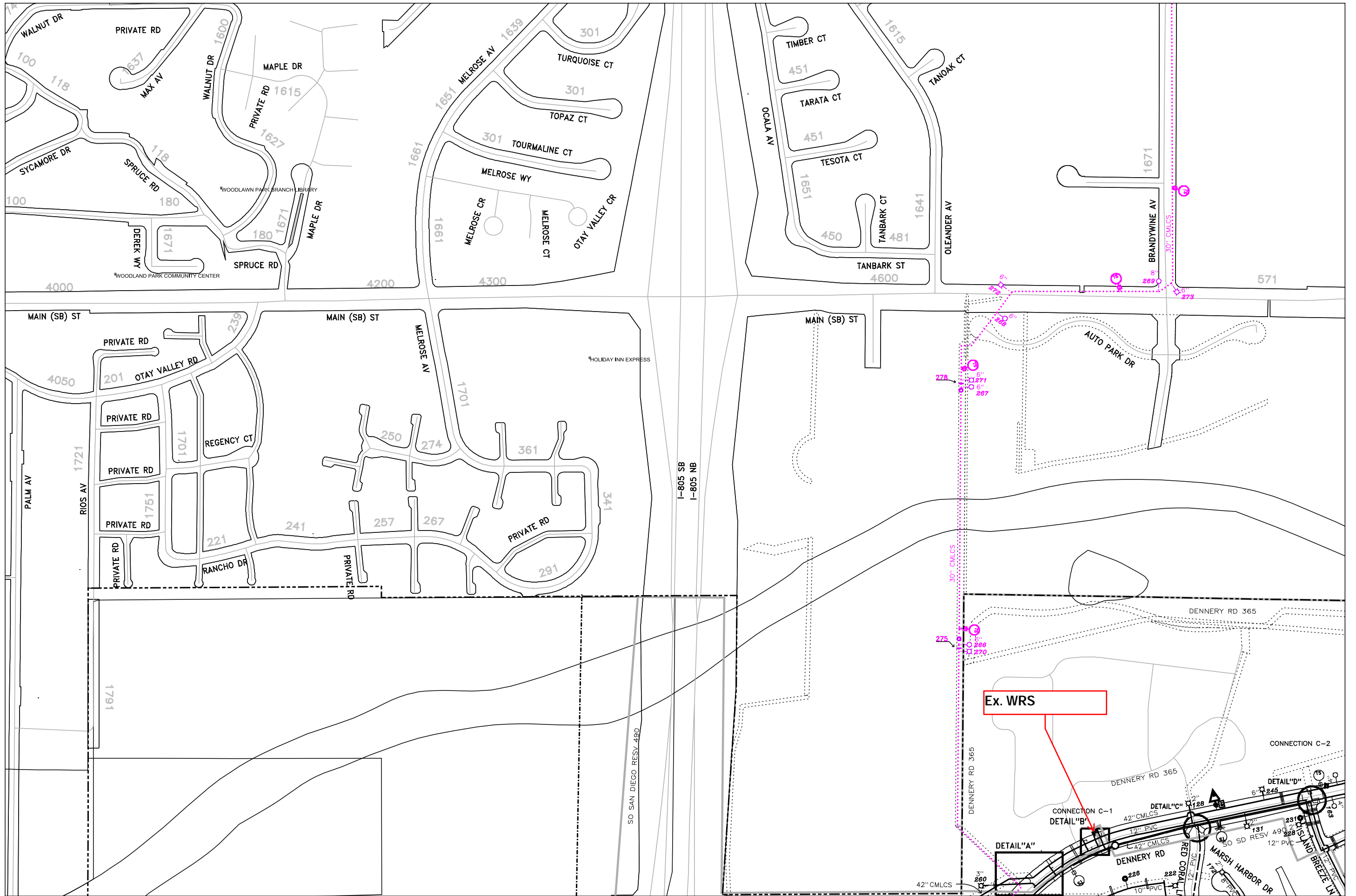

Tile Name: BG107
 NAD27: 154-1755
 NAD83: 6316407-1794444

HGL Zones: 365, 490
 Date Printed: 01-30-13

City of San Diego
 WATER FIELD BOOK

RECLAIMED WATER ON THIS MAP

L33S	M32S	N33S
	M33S	
	M34S	

THIS MAP/DATA IS PROVIDED WITHOUT WARRANTY OF ANY KIND, EITHER EXPRESS OR IMPLIED, INCLUDING BUT NOT LIMITED TO, THE IMPLIED WARRANTIES OF MERCHANTABILITY AND FITNESS FOR A PARTICULAR PURPOSE. Note: This product may contain information from the SANDAG Regional Information System which cannot be reproduced without the written permission of SANDAG. This product may contain information reproduced with permission granted by RAND McNALLY & COMPANY to SanGIS. This map is copyrighted by RAND McNALLY & COMPANY. It is unlawful to copy or reproduce all or any part thereof, whether for personal use or resale, without the prior, written permission of RAND McNALLY & COMPANY.

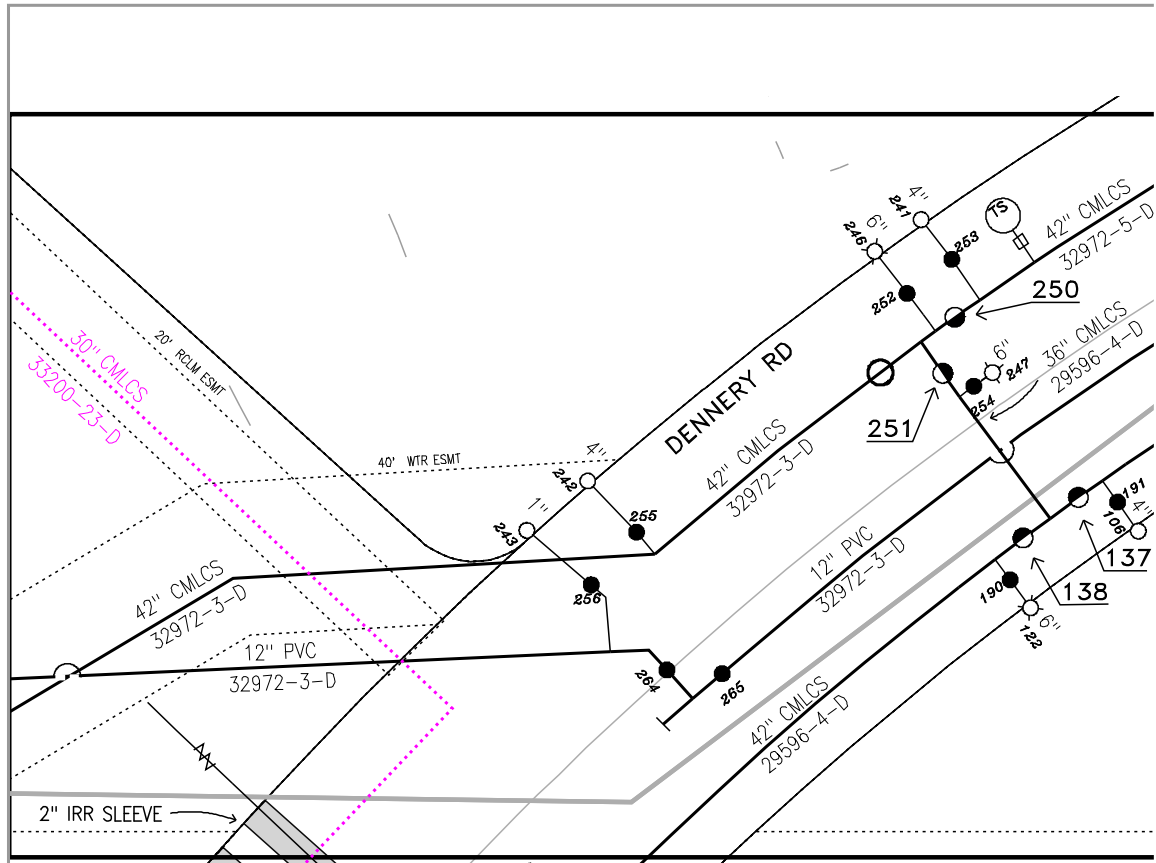

Detail: "A" 1"=50'

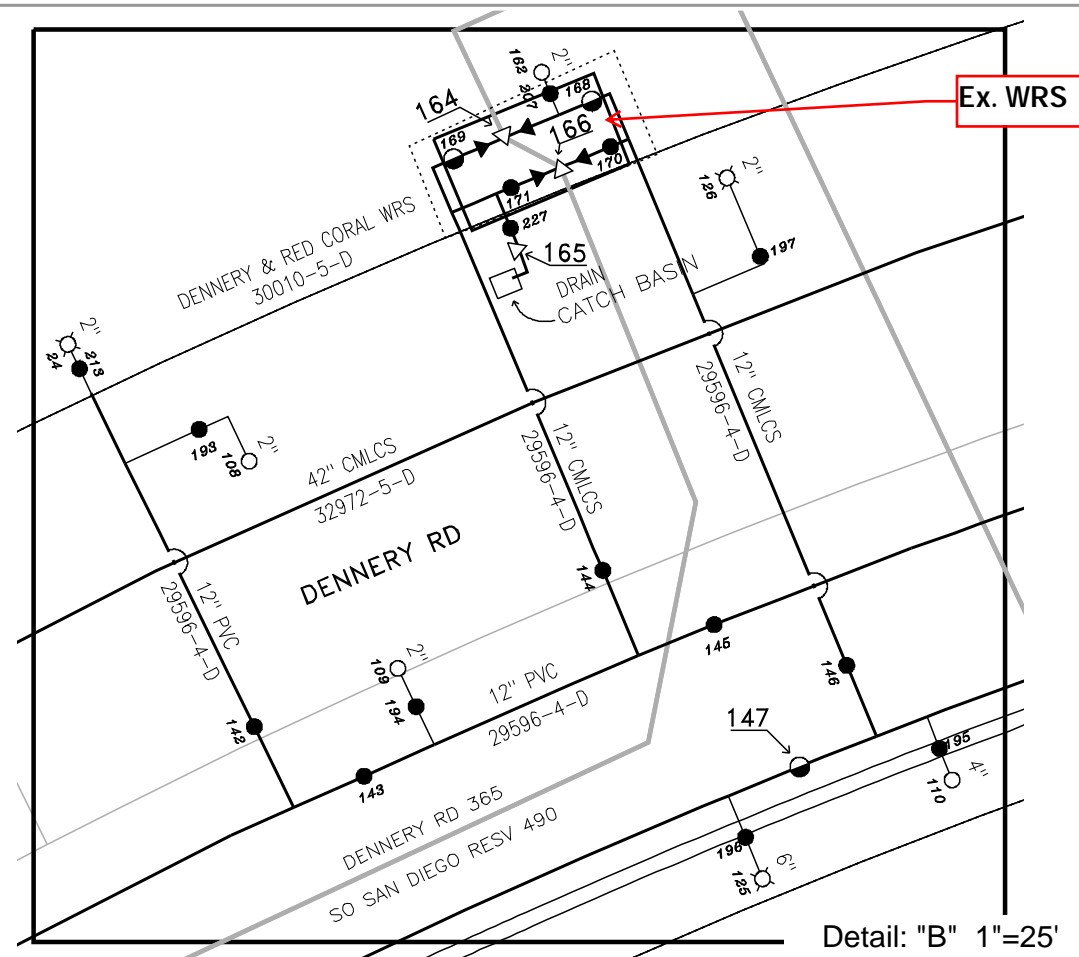

Ex. WRS

Detail: "B" 1"=25'

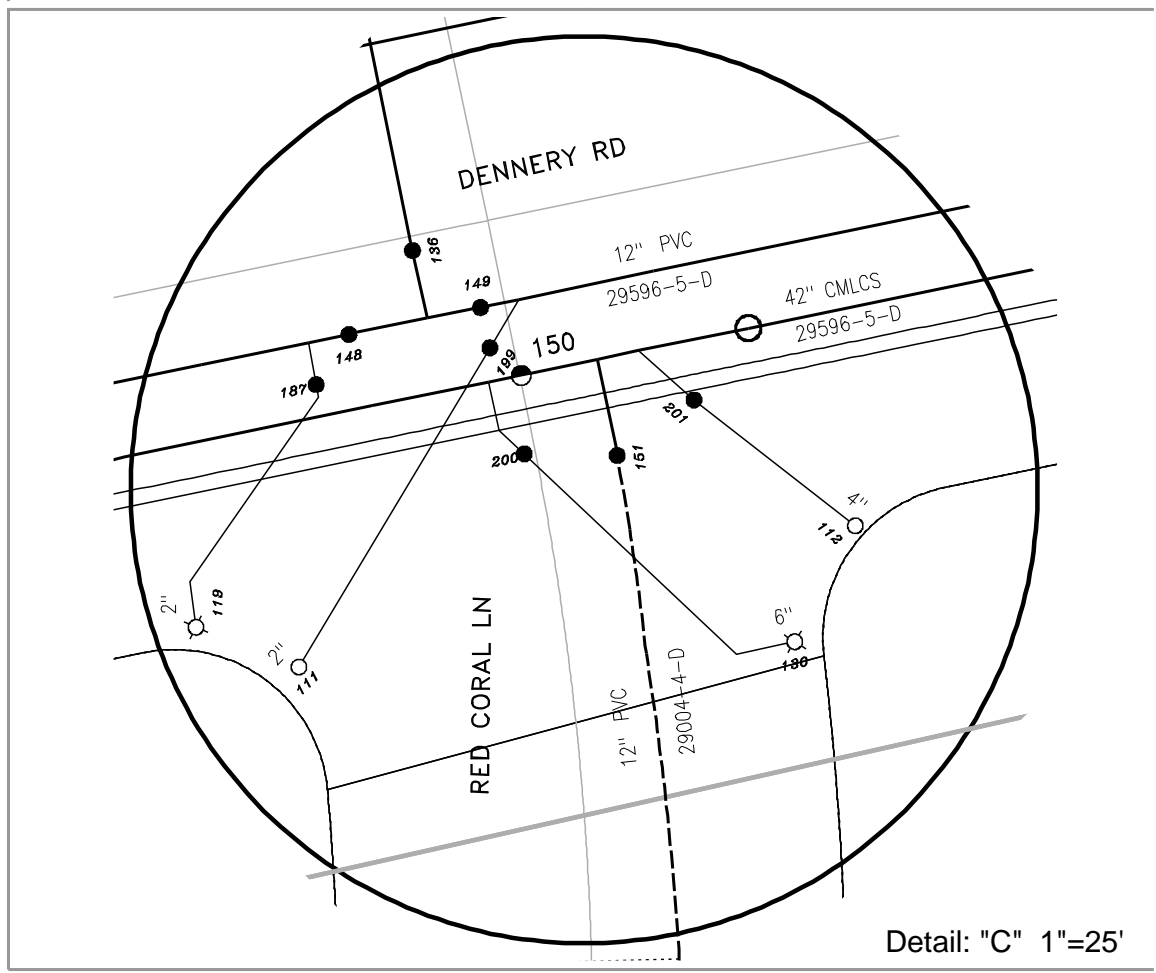

Detail: "C" 1"=25'

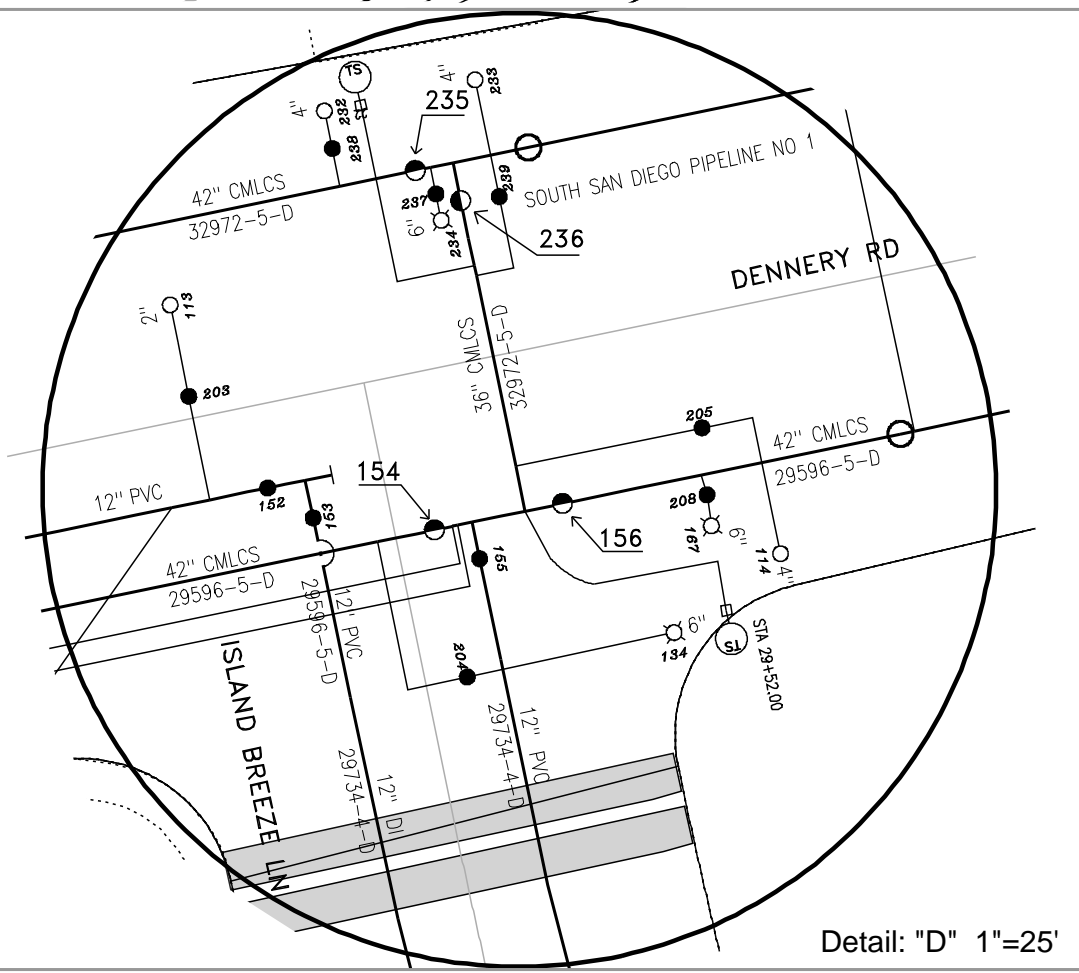

Detail: "D" 1"=25'

Water Reference Data

VALVES

MAP ID	SIZE	TYPE	CLSD RED	BP SIZE	VALVE TURNS	GR NO	DTL LTR	LOCATION
50	42"	BFV				4		S DENNERY RD BLACK CORAL WY E
90	42"	GVBP				5		QUARTERDECK LN & TOPSIDE LN
95	36"	BFV				5	B	160' SE TOPSAIL DR
96	36"	BFV				5	B	160' SE TOPSAIL DR
97	42"	BFV				5	B	160' SE TOPSAIL DR
100	42"	GVBP				4		1257' W DENNERY RD
121	42"	BFV				5	C	S OF DENNERY & TOPSIDE WRS ON DENNERY RD
124	42"	BFV				5		LOC PER J. BATES 12/21/04
129	42"	BFV				5	B	

REGULATORS

MAP ID	SIZE	TYPE	GR NO	DTL LTR	LOCATION	HI PSI	LOW PSI	HGL ZONE FROM	HGL ZONE TO	VALVE ELEV
37	10"	PRV	4	A	DENNERY & BLACK CORAL WY WRS			490 SO SAN DIEGO RESV	365 DENNERY RD	153.33
38	4"	PRV	4	A	DENNERY & BLACK CORAL WY WRS			490 SO SAN DIEGO RESV	365 DENNERY RD	153.33
39	4"	RLF	4	A	DENNERY & BLACK CORAL WY WRS			490 SO SAN DIEGO RESV	365 DENNERY RD	
149	4"	PRV	5	C	DENNERY & TOPSIDE WRS			490 SO SAN DIEGO RESV	365 DENNERY RD	154.75
150	10"	PRV	5	C	DENNERY & TOPSIDE WRS			490 SO SAN DIEGO RESV	365 DENNERY RD	154.75
151	6"	RLF	5	C	DENNERY & TOPSIDE WRS			490 SO SAN DIEGO RESV	365 DENNERY RD	154.75

THIS MAP/DATA IS PROVIDED WITHOUT WARRANTY OF ANY KIND, EITHER EXPRESS OR IMPLIED, INCLUDING BUT NOT LIMITED TO, THE IMPLIED WARRANTIES OF MERCHANTABILITY AND FITNESS FOR A PARTICULAR PURPOSE. Note: This product may contain information from the SANDAG Regional Information System which cannot be reproduced without the written permission of SANDAG. This product may contain information reproduced with permission granted by RAND MCNALLY & COMPANY® to SanGIS. This map is copyrighted by RAND MCNALLY & COMPANY®. It is unlawful to copy or reproduce all or any part thereof, whether for personal use or resale, without the prior, written permission of RAND MCNALLY & COMPANY®.

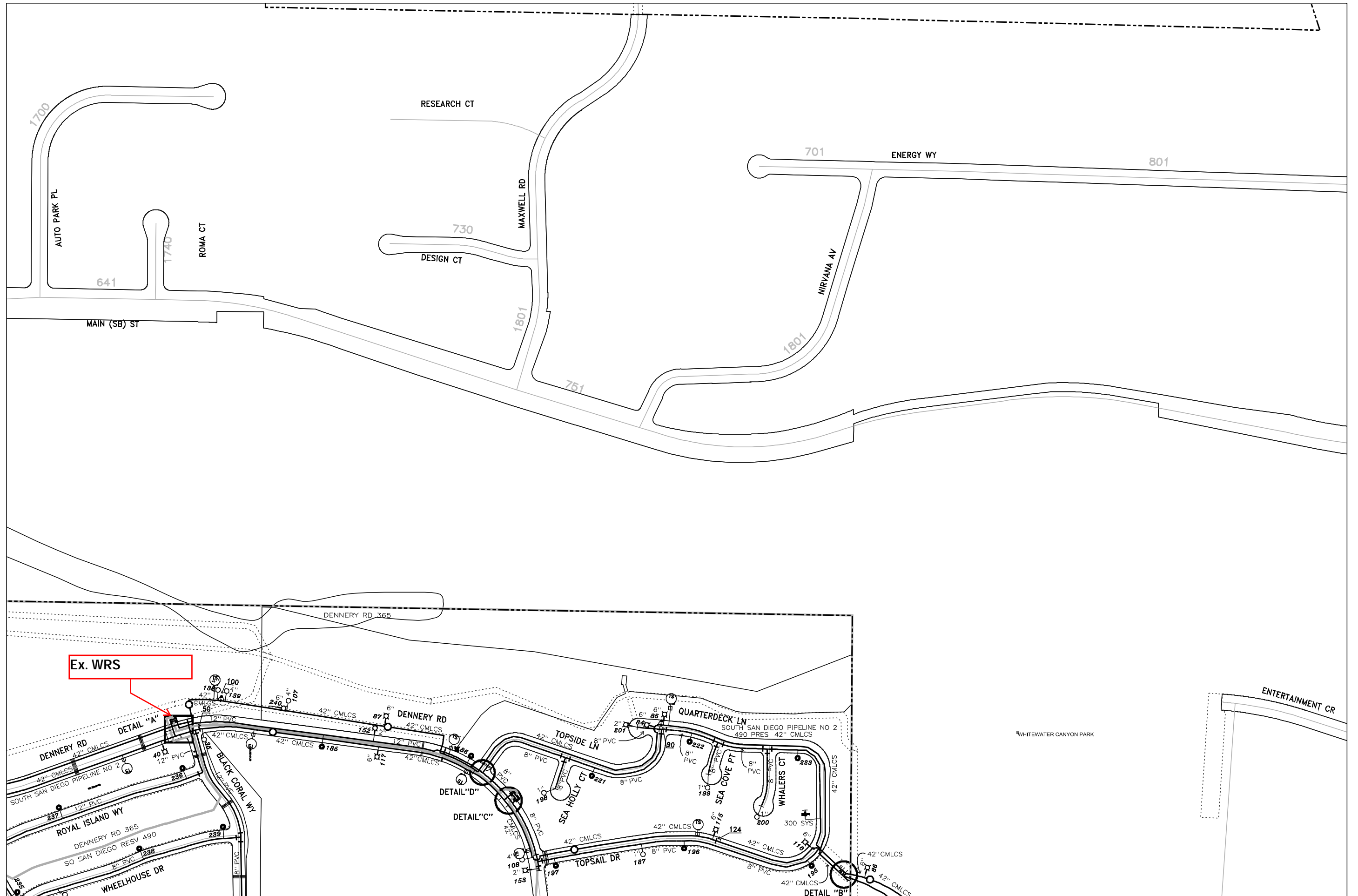

Ex. WRS

Tile Name: BH107
 NAD27: 154-1761
 NAD83: 6322407-1794444

HGL Zones: 365, 490
 Date Printed: 01-30-13

City of San Diego
 WATER FIELD BOOK

	N32S	
M33S	N33S	O33S
	N34S	

THIS MAP/DATA IS PROVIDED WITHOUT WARRANTY OF ANY KIND, EITHER EXPRESS OR IMPLIED, INCLUDING BUT NOT LIMITED TO, THE IMPLIED WARRANTIES OF MERCHANTABILITY AND FITNESS FOR A PARTICULAR PURPOSE. Note: This product may contain information from the SANDAG Regional Information System which cannot be reproduced without the written permission of SANDAG. This product may contain information reproduced with permission granted by RAND McNALLY & COMPANY to SanGIS. This map is copyrighted by RAND McNALLY & COMPANY. It is unlawful to copy or reproduce all or any part thereof, whether for personal use or resale, without the prior, written permission of RAND McNALLY & COMPANY.

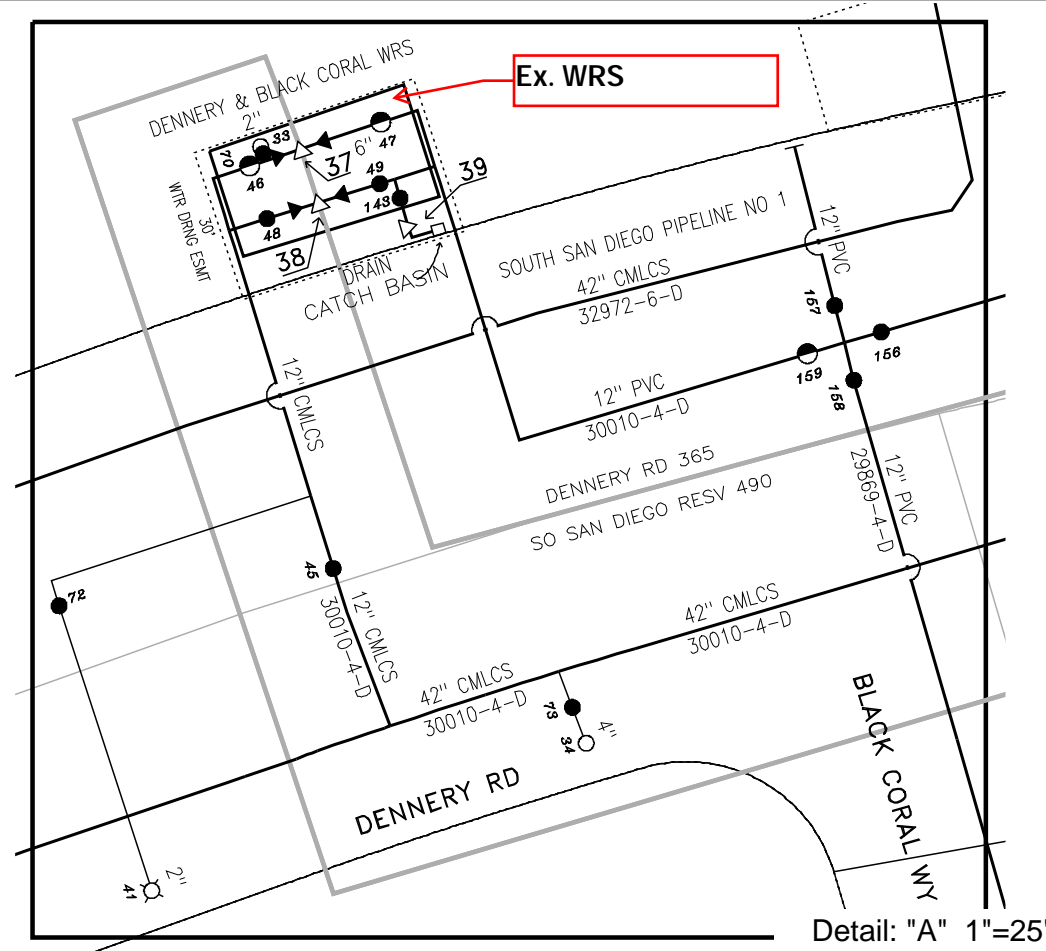

Detail: "A" 1"=25'

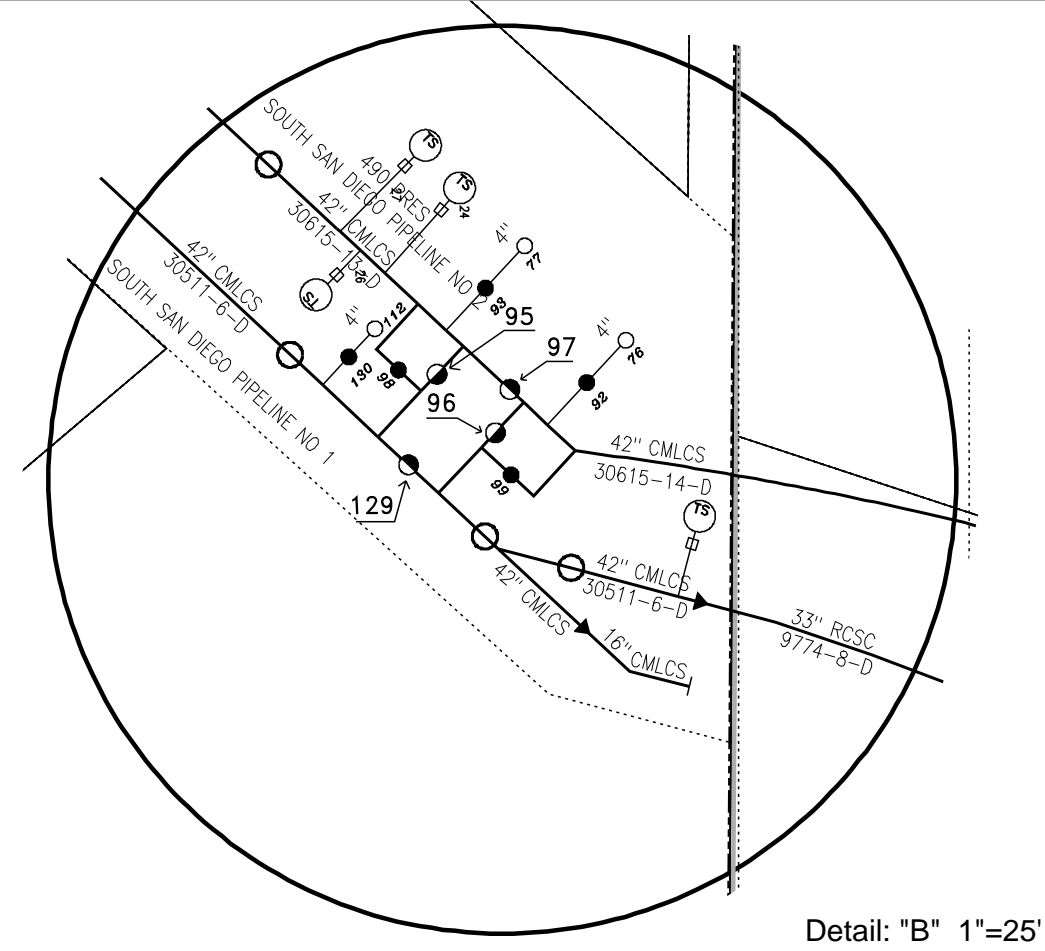

Detail: "B" 1"=25'

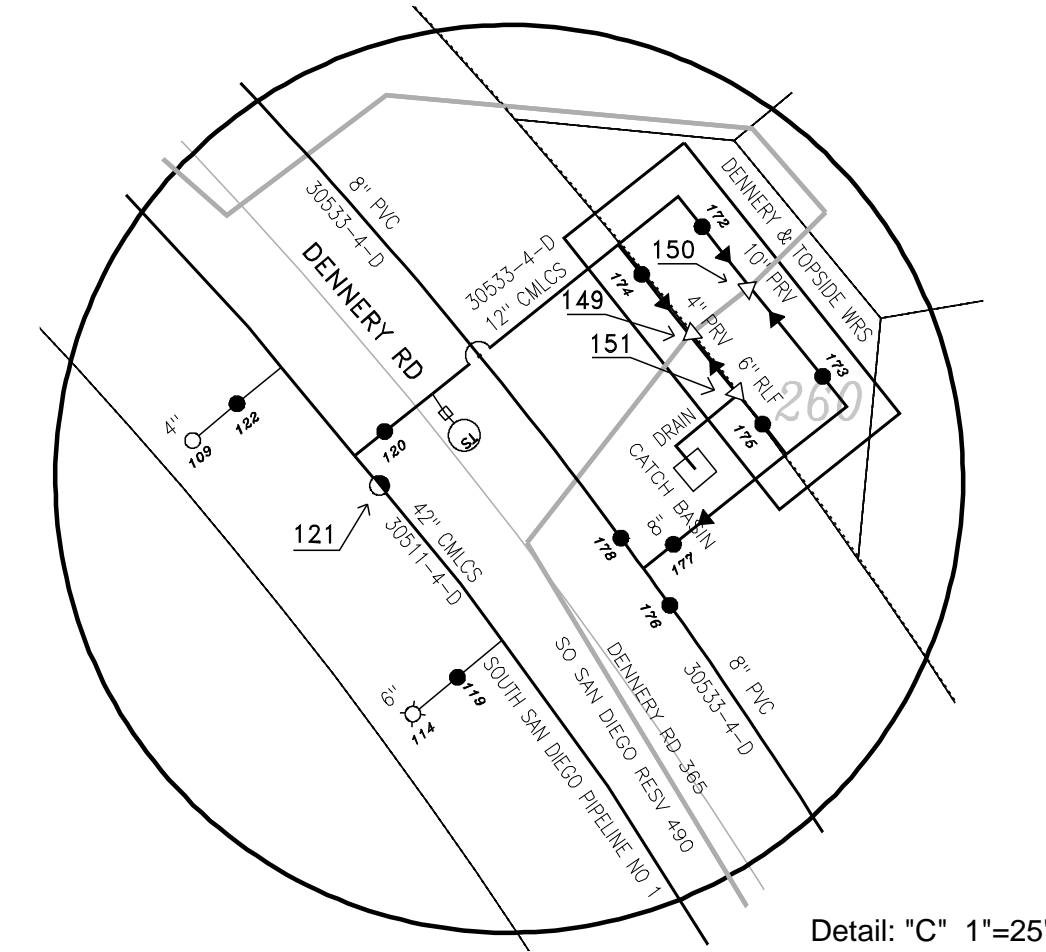

Detail: "C" 1"=25'

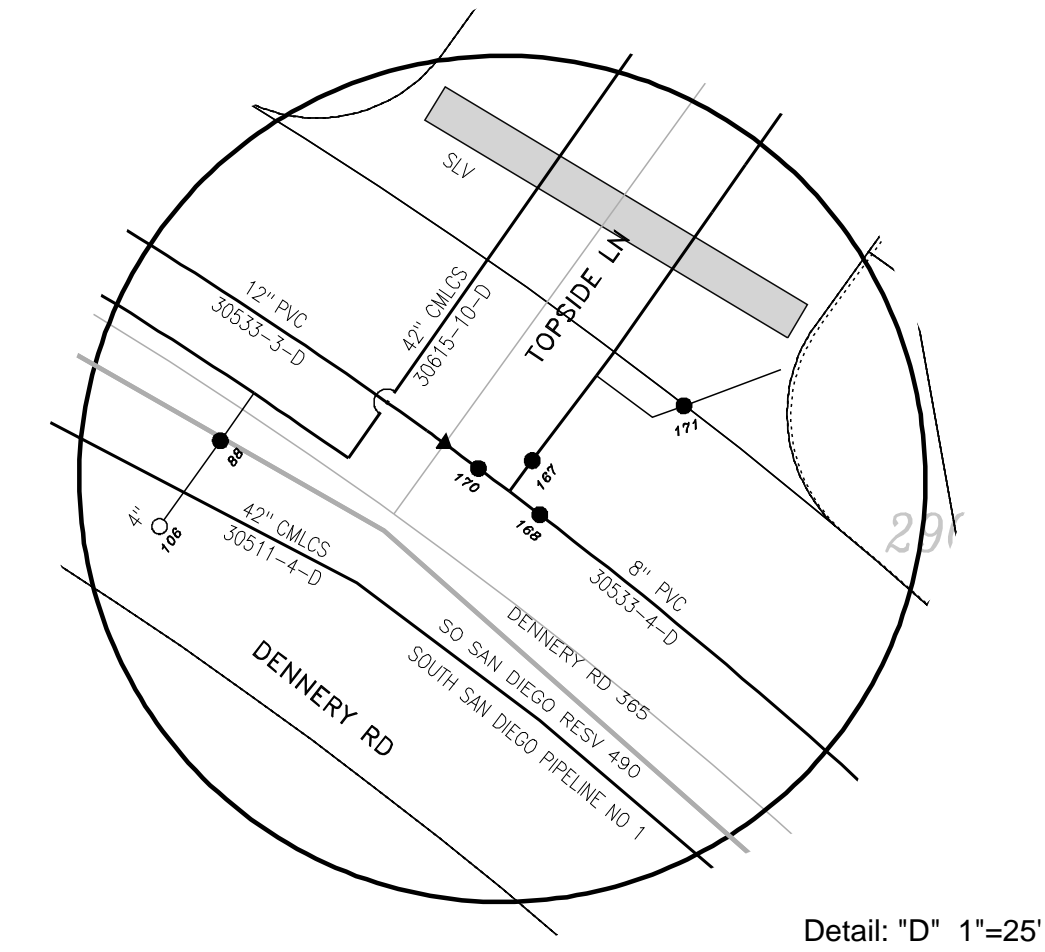

Detail: "D" 1"=25'



MODEL 90-01

Pressure Reducing Valve

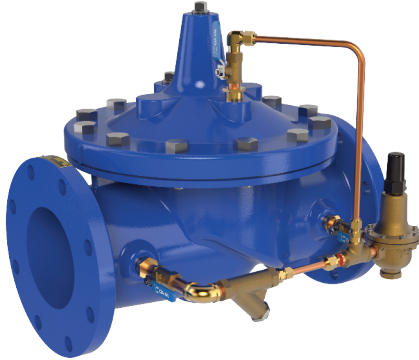

- Sensitive and Accurate Pressure Control
- Easy Adjustment and Maintenance
- Optional Check Feature
- Fully Supported Frictionless Diaphragm
- Meets National Lead Reduction Mandate

The Cla-Val Model 90-01 Pressure Reducing Valve automatically reduces a higher inlet pressure to a steady lower downstream pressure, regardless of changing flow rate and/or varying inlet pressure. This valve is an accurate, pilot-operated regulator capable of holding downstream pressure to a pre-determined limit. When downstream pressure exceeds the pressure setting of the control pilot, the main valve and pilot valve close drip-tight.

If a check feature is added, and a pressure reversal occurs, the downstream pressure is admitted into the main valve cover chamber, closing the valve to prevent return flow.

For space savings, see Cla-Val Model 90-48 or 90-99 with integral Low Flow Bypass Pressure Regulator.

Schematic Diagram

Item	Description
1	100-01 Hytrol Main Valve
2	X58 Restriction Fitting
3	CRD Pressure Reducing Control

Optional Features

Item	Description
A	X46A Flow Clean Strainer
B	CK2 Isolation Valve
C	CV Flow Control (Closing)*
D	Check Valves with Isolation Valve
M	X144 e-FlowMeter
P	X141 Pressure Gauge
S	CV Flow Control (Opening)
V	X101 Valve Position Indicator
Y	X43 "Y" Strainer

*The closing speed control (optional) on this valve should always be open at least three (3) turns off its seat.

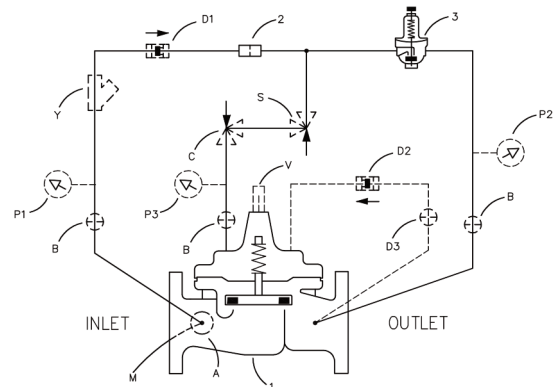

Typical Applications

Typical applications include pressure reducing valve station using Model 90-01 and Model 90-01 in parallel to handle wide range of flow rates. Larger Model 90-01 valve meets requirements of peak loads and smaller Model 90-01 handles low flows. A downstream pressure relief valve is also recommended for this type of application.

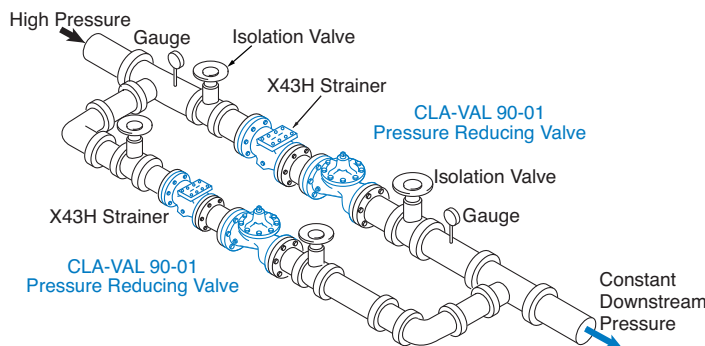

Cla-Val Model 90-01KO Pressure Reducing Valve with Anti-Cavitation Trim provides for optimum downstream pressure control while reducing noise and eliminating damage associated with cavitation. See Cavitation Guide to determine if the valve is a candidate for the KO Anti-Cavitation Trim. A downstream pressure relief valve is recommended for this type of application.

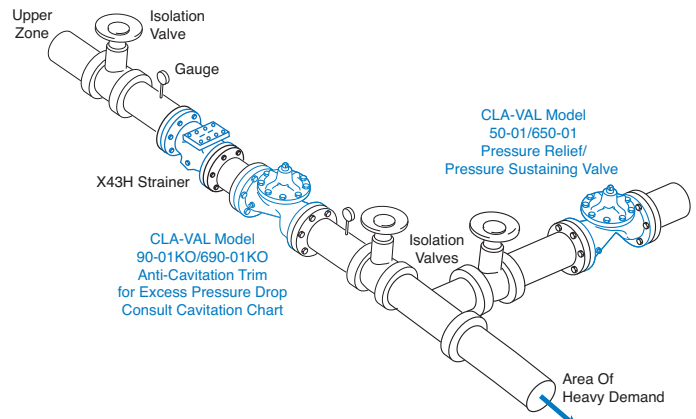

Model 90-01 (Uses 100-01 Hytrol Main Valve)

Pressure Ratings (Recommended Maximum Pressure - psi)

Valve Body & Cover		Pressure Class				
		Flanged		Grooved	Threaded	
Grade	Material	ANSI Standards*	150 Class	300 Class	300 Class	End‡ Details
ASTM A536	Ductile Iron	B16.42	250	400	400	400
ASTM A216-WCB	Cast Steel	B16.5	285	400	400	400
UNS 87850	Bronze	B16.24	225	400	400	400

Note: * ANSI standards are for flange dimensions only.
 Flanged valves are available faced but not drilled.
 ‡ End Details machined to ANSI B2.1 specifications.
Valves for higher pressure are available; consult factory for details

Materials

Component	Standard Material Combinations		
Body & Cover	Ductile Iron	Cast Steel	Bronze
Available Sizes	1" - 36" 25 - 900mm	1" - 16" 25 - 400mm	1" - 16" 25 - 400mm
Disc Retainer & Diaphragm Washer	Cast Iron	Cast Steel	Bronze
Trim: Disc Guide, Seat & Cover Bearing	Bronze is Standard Stainless Steel is Optional		
Disc	Buna-N® Rubber		
Diaphragm	Nylon Reinforced Buna-N® Rubber		
Stem, Nut & Spring	Stainless Steel		

For material options not listed, consult factory.
 Cla-Val manufactures valves in more than 50 different alloys.

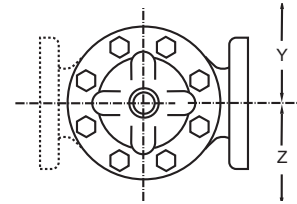
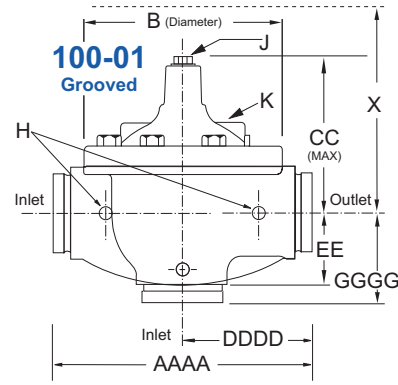
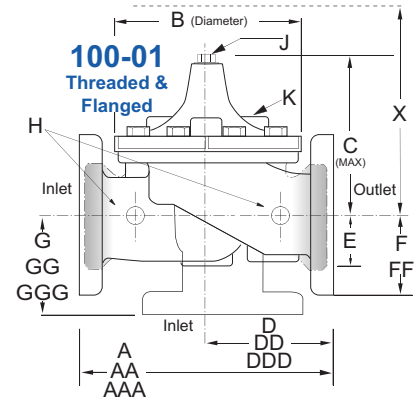

Model 90-01 Dimensions (In Inches)

Valve Size (Inches)	1	1 1/4	1 1/2	2	2 1/2	3	4	6	8	10	12	14	16	18	20	24	30	36
A Threaded	7.25	7.25	7.25	9.38	11.00	12.50	—	—	—	—	—	—	—	—	—	—	—	—
AA 150 ANSI	—	—	8.50	9.38	11.00	12.00	15.00	20.00	25.38	29.75	34.00	39.00	41.38	46.00	52.00	61.50	63.00	72.75
AAA 300 ANSI	—	—	9.00	10.00	11.62	13.25	15.62	21.00	26.38	31.12	35.50	40.50	43.50	47.64	53.62	63.24	64.50	74.75
AAAA Grooved End	—	—	8.50	9.00	11.00	12.50	15.00	20.00	25.38	—	—	—	—	—	—	—	—	—
B Diameter	5.62	5.62	5.62	6.62	8.00	9.12	11.50	15.75	20.00	23.62	28.00	32.75	35.50	41.50	45.00	53.16	56.00	66.00
C Maximum	5.50	5.50	5.50	6.50	7.56	8.19	10.62	13.38	16.00	17.12	20.88	24.19	25.00	39.06	41.90	43.93	54.60	59.00
CC Maximum Grooved End	—	—	4.75	5.75	6.88	7.25	9.31	12.12	14.62	—	—	—	—	—	—	—	—	—
D Threaded	3.25	3.25	3.25	4.75	5.50	6.25	—	—	—	—	—	—	—	—	—	—	—	—
DD 150 ANSI	—	—	4.00	4.75	5.50	6.00	7.50	10.00	12.69	14.88	17.00	19.50	20.81	—	—	30.75	—	—
DDD 300 ANSI	—	—	4.25	5.00	5.88	6.38	7.88	10.50	13.25	15.56	17.75	20.25	21.62	—	—	31.62	—	—
DDDD Grooved End	—	—	—	4.75	—	6.00	7.50	—	—	—	—	—	—	—	—	—	—	—
E	1.12	1.12	1.12	1.50	1.69	2.06	3.19	4.31	5.31	9.25	10.75	12.62	15.50	12.95	15.00	17.75	21.31	24.56
EE Grooved End	—	—	2.00	2.50	2.88	3.12	4.25	6.00	7.56	—	—	—	—	—	—	—	—	—
F 150 ANSI	—	—	2.50	3.00	3.50	3.75	4.50	5.50	6.75	8.00	9.50	10.50	11.75	15.00	16.50	19.25	22.50	28.50
FF 300 ANSI	—	—	3.06	3.25	3.75	4.13	5.00	6.25	7.50	8.75	10.25	11.50	12.75	15.00	16.50	19.25	24.00	30.00
G Threaded	1.88	1.88	1.88	3.25	4.00	4.50	—	—	—	—	—	—	—	—	—	—	—	—
GG 150 ANSI	—	—	4.00	3.25	4.00	4.00	5.00	6.00	8.00	8.62	13.75	14.88	15.69	—	—	22.06	—	—
GGG 300 ANSI	—	—	4.25	3.50	4.31	4.38	5.31	6.50	8.50	9.31	14.50	15.62	16.50	—	—	22.90	—	—
GGGG Grooved End	—	—	—	3.25	—	4.25	5.00	—	—	—	—	—	—	—	—	—	—	—
H NPT Body Tapping	0.375	0.375	0.375	0.375	0.50	0.50	0.75	0.75	1.00	1.00	1.00	1.00	1.00	1.00	1.00	1.00	2.00	2.00
J NPT Cover Center Plug	0.25	0.25	0.25	0.50	0.50	0.50	0.75	0.75	1.00	1.00	1.25	1.50	2.00	1.00	1.00	1.00	2.00	2.00
K NPT Cover Tapping	0.375	0.375	0.375	0.375	0.50	0.50	0.75	0.75	1.00	1.00	1.00	1.00	1.00	1.00	1.00	1.00	2.00	2.00
Stem Travel	0.40	0.40	0.40	0.60	0.70	0.80	1.10	1.70	2.30	2.80	3.40	4.00	4.50	5.10	5.63	6.75	7.50	8.50
Approx. Ship Weight (lbs)	15	15	15	35	50	70	140	285	500	780	1165	1600	2265	2982	3900	6200	7703	11720
Approx. X Pilot System	11	11	11	13	14	15	17	29	31	33	36	40	40	43	47	68	79	85
Approx. Y Pilot System	9	9	9	9	10	11	12	20	22	24	26	29	30	32	34	39	40	45
Approx. Z Pilot System	9	9	9	9	10	11	12	20	22	24	26	29	30	32	34	39	42	47

Model 90-01 Metric Dimensions (Uses 100-01 Hytrol Main Valve)

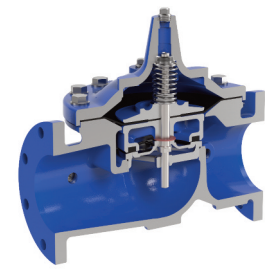
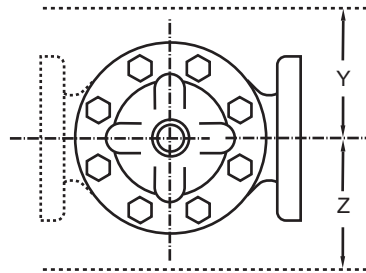
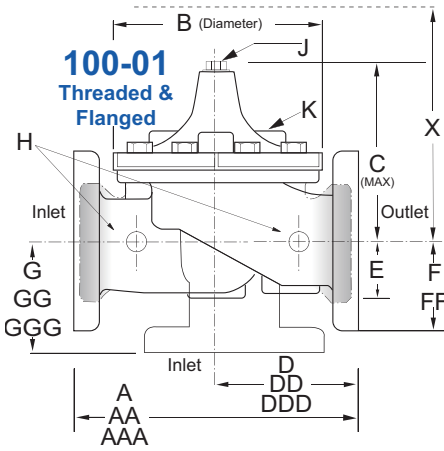

Model 100-01 Full Port Hytrol Main Valve

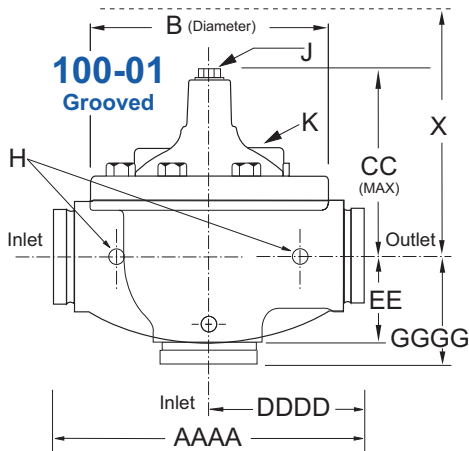

Other 90 Series Products

- 90-01KO - Model 90-01 supplied with with KO Anti-Cavitation Trim
- 90-01H - Model 90-01 supplied with X43H Strainer
- 90-01KOH - Model 90-01 supplied with KO Trim & X43H Strainer
- 690-01 - Reduced Port Pressure Reducing Valve
- 690-01KO - Reduced Port Pressure Reducing Valve with KO Trim
- 690-01H - Reduced Port Pressure Reducing Valve with X43H Strainer
- 690-01KOH - Reduced Port Pressure Reducing Valve with KO Trim and X43H Strainer

Model 90-01 Dimensions (In mm)

Valve Size (mm)	25	32	40	50	65	80	100	150	200	250	300	350	400	450	500	600	750	900
A Threaded	184	184	184	238	279	318	—	—	—	—	—	—	—	—	—	—	—	—
AA 150 ANSI	—	—	216	238	279	305	381	508	645	756	864	991	1051	1168	1321	1562	1600	1848
AAA 300 ANSI	—	—	229	254	295	337	397	533	670	790	902	1029	1105	1210	1326	1606	1638	1899
AAAA Grooved End	—	—	216	228	279	318	381	508	645	—	—	—	—	—	—	—	—	—
B Diameter	143	143	143	168	203	232	292	400	508	600	711	832	902	1054	1143	1350	1422	1676
C Maximum	140	140	140	165	192	208	270	340	406	435	530	614	635	992	1064	1116	1387	1499
CC Maximum Grooved End	—	—	120	146	175	184	236	308	371	—	—	—	—	—	—	—	—	—
D Threaded	83	83	83	121	140	159	—	—	—	—	—	—	—	—	—	—	—	—
DD 150 ANSI	—	—	102	121	140	152	191	254	322	378	432	495	528	—	—	781	—	—
DDD 300 ANSI	—	—	108	127	149	162	200	267	337	395	451	514	549	—	—	803	—	—
DDDD Grooved End	—	—	—	121	—	152	191	—	—	—	—	—	—	—	—	—	—	—
E	29	29	29	38	43	52	81	110	135	235	273	321	394	329	381	451	541	624
EE Grooved End	—	—	52	64	73	79	108	152	192	—	—	—	—	—	—	—	—	—
F 150 ANSI	—	—	64	76	89	95	114	140	171	203	241	267	298	381	419	489	572	724
FF 300 ANSI	—	—	78	83	95	105	127	159	191	222	260	292	324	381	419	489	610	762
G Threaded	48	48	48	83	102	114	—	—	—	—	—	—	—	—	—	—	—	—
GG 150 ANSI	—	—	102	83	102	102	127	152	203	219	349	378	399	—	—	560	—	—
GGG 300 ANSI	—	—	102	89	110	111	135	165	216	236	368	397	419	—	—	582	—	—
GGGG Grooved End	—	—	—	83	—	108	127	—	—	—	—	—	—	—	—	—	—	—
H NPT Body Tapping	0.375	0.375	0.375	0.375	0.50	0.50	0.75	0.75	1.00	1.00	1.00	1.00	1.00	1.00	1.00	1.00	2.00	2.00
J NPT Cover Center Plug	0.25	0.25	0.25	0.50	0.50	0.50	0.75	0.75	1.00	1.00	1.25	1.50	2.00	1.00	1.00	1.00	2.00	2.00
K NPT Cover Tapping	0.375	0.375	0.375	0.375	0.50	0.50	0.75	0.75	1.00	1.00	1.00	1.00	1.00	1.00	1.00	1.00	2.00	2.00
Stem Travel	10	10	10	15	18	20	28	43	58	71	86	102	114	130	143	171	190	216
Approx. Ship Weight (kgs)	7	7	7	16	23	32	64	129	227	354	528	726	1027	1353	1769	2812	3494	5316
Approx. X Pilot System	280	280	280	331	356	381	432	737	788	839	915	1016	1016	1093	1194	1728	2007	2159
Approx. Y Pilot System	229	229	229	229	254	280	305	508	559	610	661	737	762	813	864	991	1016	1143
Approx. Z Pilot System	229	229	229	229	254	280	305	508	559	610	661	737	762	813	864	991	1067	1194

90-01 Valve Selection	100-01 Pattern: Globe (G), Angle (A), End Connections: Threaded (T), Grooved (GR), Flanged (F) Indicate Available Sizes																			
	Inches	1	1¼	1½	2	2½	3	4	6	8	10	12	14	16	18	20	24	30	36	
	mm	25	32	40	50	65	80	100	150	200	250	300	350	400	450	500	600	750	900	
Main Valve 100-01	Pattern	G, A	G, A	G, A	G, A	G, A	G, A	G, A	G, A	G, A	G, A	G, A	G, A	G, A	G	G	G, A	G	G	
	End Detail	T	T	T, F, Gr*	T, F, Gr	T, F, Gr*	T, F, Gr	F, Gr	F, Gr*	F, Gr*	F	F	F	F	F	F	F	F	F	
Suggested Flow (gpm)	Maximum	55	93	125	210	300	460	800	1800	3100	4900	7000	8400	11000	14000	17000	25000	42000	50000	
	Maximum Intermittent	68	120	160	260	370	580	990	2250	3900	6150	8720	10540	13700	17500	21700	31300	48000	62500	
	Minimum	1	1	1	1	2	2	4	10	15	35	50	70	95	120	150	275	450	650	
Suggested Flow (Liters/Sec)	Maximum	3.5	6	8	13	19	29	50	113	195	309	442	530	694	883	1073	1577	2650	3150	
	Maximum Intermittent	4.3	7.6	10	16	23	37	62	142	246	387	549	664	863	1104	1369	1972	3028	3940	
	Minimum	.03	.03	.03	.06	.09	0.13	0.25	0.63	0.95	2.2	3.2	4.4	6.0	7.6	9.5	17.4	28.4	41.0	

100-01 Series is the full internal port Hytrol.

For Lower Flows Consult Factory

*Globe Grooved Only

Max. flow at Ex. WRS

Notes:

- For sizes 18 through 36-inches / 450 mm though 900 mm, consult Factory
- Many factors should be considered in sizing pressure reducing valves including inlet pressure, outlet pressure and flow rates.
- For sizing questions or cavitation analysis, consult Cla-Val with system details.

Pilot System Specifications



Adjustment Ranges

- 2 to 30 psi
- 15 to 75 psi
- 20 to 105 psi
- 30 to 300 psi*
- 150 to 600 psi (CRD-18)

*Supplied unless otherwise specified

Temperature Range
Water: to 180°F

Materials

Standard Pilot System Materials

- Pilot Control: Low Lead Bronze
- Trim: Stainless Steel Type 303
- Rubber: Buna-N® Synthetic Rubber

Optional Pilot System Materials

Pilot Systems are available with optional Stainless Steel or Monel materials.

Note: Available with remote sensing control.

When Ordering, Specify:

1. Catalog No. 90-01
2. Valve Size
3. Pattern - Globe or Angle
4. Pressure Class
5. Threaded, Flanged or Grooved
6. Trim Material
7. Adjustment Range
8. Desired Options
9. When Vertically Installed

Main Valve Options

EPDM Rubber Parts

Optional diaphragm, disc and o-ring fabricated with EPDM synthetic rubber

Viton® Rubber Parts - suffix KB

Optional diaphragm, disc and o-ring fabricated with Viton® synthetic rubber

Epoxy Coating - suffix KC

NSF/ANSI 61 Fusion Bonded Epoxy

Dura-Kleen® Stem - suffix KD

Fluted design prevents dissolved minerals build-up on the stem

LFS Trim

Designed to regulate precisely and smoothly at typical flow rates as well as lower than the industry standard of 1 fps, without decreasing the valve's capacity

Valve Options

X141 Pressure Gauge



X101AR Valve Position Indicator with Air Release



X101 Valve Position Indicator



X144 e-FlowMeter



X43H Strainer



Stainless Steel Pilot

APPENDIX B

**PRIVATE DOMESTIC WATER
BACKGROUND INFORMATION**

Water Fixture Unit Calculations

Nakano
Preliminary Domestic Water System Analysis

Job Number 648-038
Date June 20, 2022

Water Fixture Units:

DESCRIPTION	Plan 1			Plan 2			Plan 3		
	FIXTURE		TOTAL	FIXTURE		TOTAL	FIXTURE		TOTAL
	QUANTITY	UNITS	FIXTURE	QUANTITY	UNITS	FIXTURE	QUANTITY	UNITS	FIXTURE
	EACH		UNITS	EACH		UNITS	EACH		UNITS
CLOTHES WASHER	1	4	4	1	4	4	1	4	4
TUB/SHOWER	3	4	12	2	4	8	1	4	4
SHOWER	1	2	2	1	2	2	1	2	2
KITCHEN SINK	1	1.5	1.5	1	1.5	1.5	1	1.5	1.5
BAR SINK	0	1	0	0	1	0	0	1	0
DISHWASHER	1	1.5	1.5	1	1.5	1.5	1	1.5	1.5
LAUNDRY SINK	0	1.5	0	0	1.5	0	0	1.5	0
LAVATORY	4	1	4	3	1	3	3	1	3
WATER CLOSET (1.6 GPF, private)	3	2.5	7.5	3	2.5	7.5	2	2.5	5
HOSE BIBB	1	2.5	2.5	1	2.5	2.5	1	2.5	2.5
EACH ADDTL HB	1	1	1	1	1	1	1	1	1
TOTAL			36			31			24.5

Plan	# of Units	Total WFU
1	67	2412
2	84	2604
3	70	1715
Total	221	6731

From Chart A 103.1(1) of the 2019 California Plumbing Code:
6,731 WFU = 818 gpm; per City of San Diego Meter Sizing Criteria

NOTE: Floor plans are not finalized and the above WFU count is a representation of a similar architectural product.

**CHART A 103.1(1)
ESTIMATE CURVES FOR DEMAND LOAD**

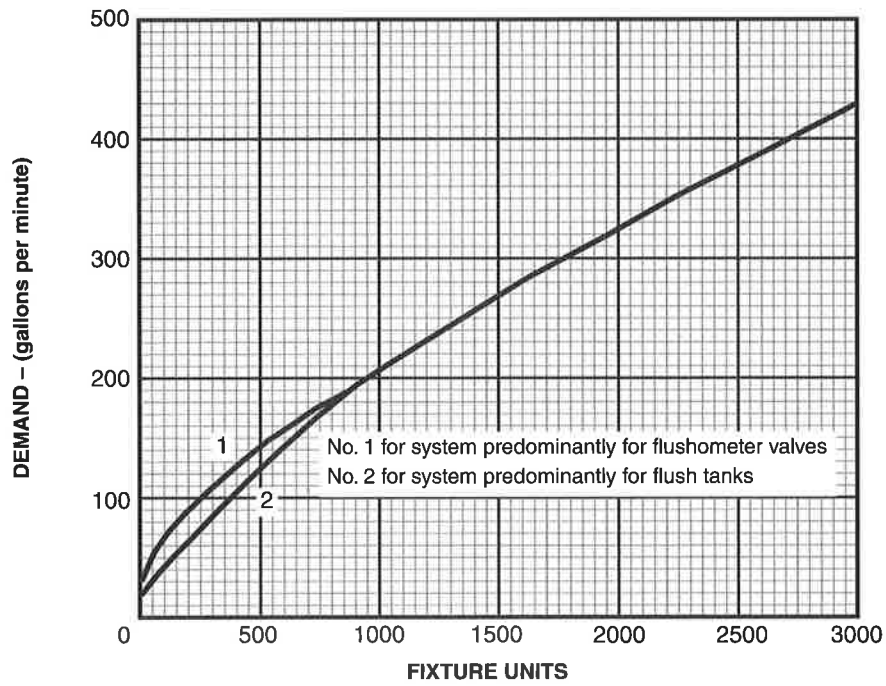

For SI units: 1 gallon per minute = 0.06 L/s

**CHART A 103.1(2)
ENLARGED SCALE DEMAND LOAD**

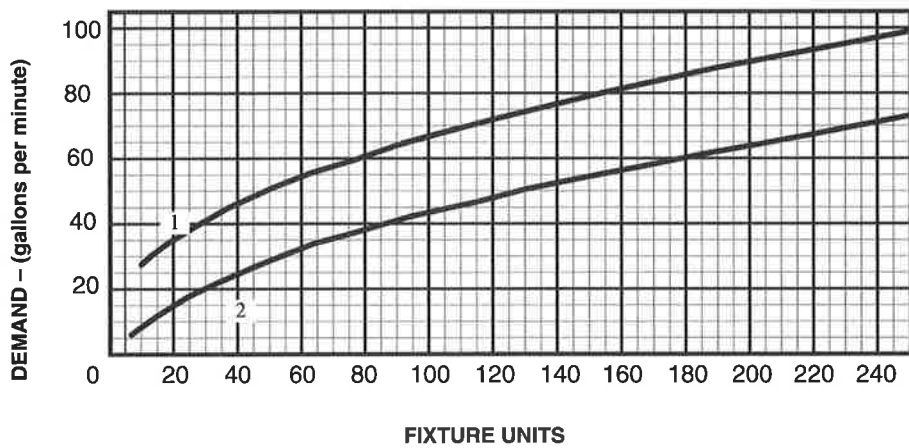

For SI units: 1 gallon per minute = 0.06 L/s

WFU	Demand, gpm	Demand, gpm
6,731	818	727

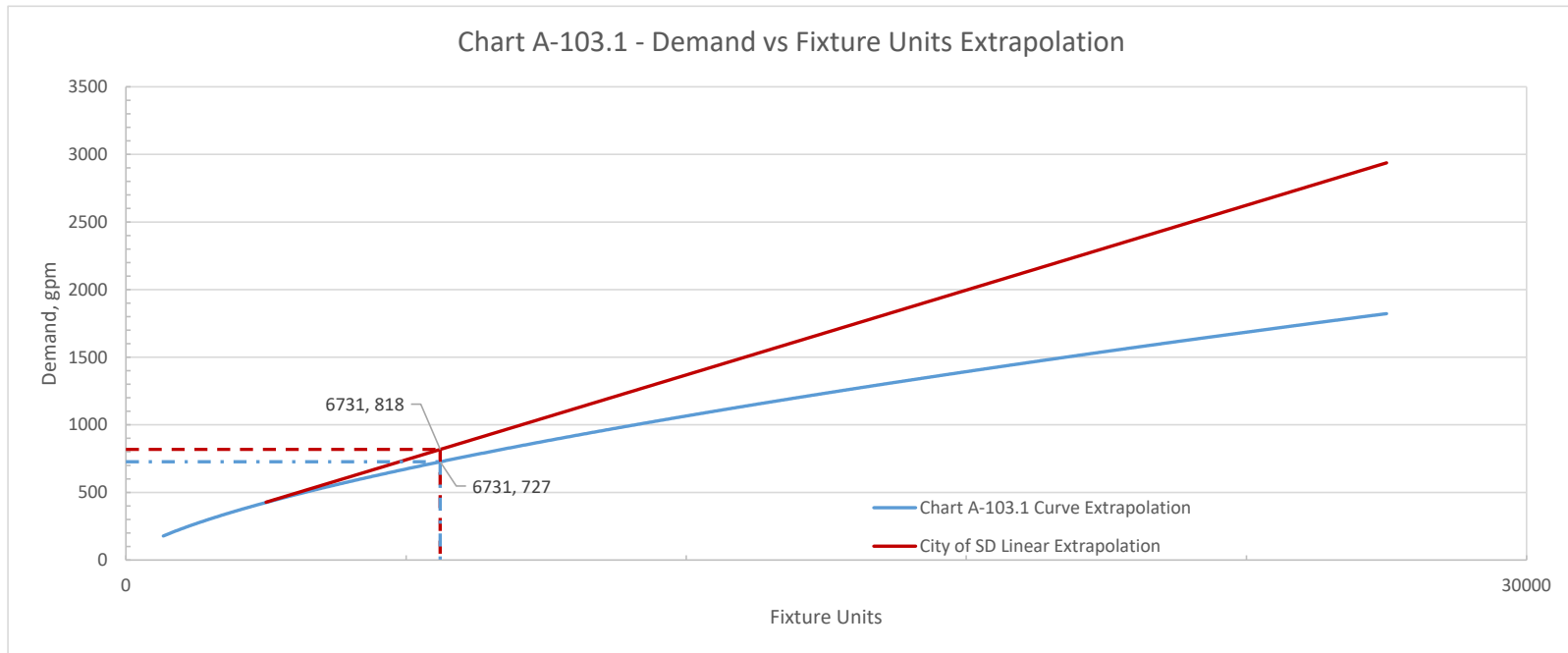

Graph data and line fit are based on Chart A-103.1 from the 2019 CPC.

2015 AWWA Standards for Water Meter Capacities

Meter Size	City of San Diego 1973 AWWA Table		2015 AWWA Standards	
	Max Capacity per AWWA (gpm)	City Uses 80% of Max Capacity (gpm)	Max Capacity per AWWA (gpm)	City Uses 80% of Max Capacity (gpm)
Displacement Type Meters - AWWA C700-15				
5/8 x 3/4	20	16	20	16
3/4	30	24	30	24
1	50	40	50	40
1-1/2	100	80	100	80
2	160	128	160	128
Compound Type Meters - AWWA C702-15				
3	320	250	350	280
4	500	400	600	480
6	1,000	800	1,350	1,080
8	1,600	1,280	1,600	1,280
Turbine Type Meters - AWWA C701-15 Class II				
3	350	280	435	348
4	600	480	750	600
6	1,250	1,000	1,600	1,280
8			2,800	2,240
10			4,200	3,360
12			5,300	4,240
16			7,800	6,240
20			12,000	9,600

August 23, 2016

Notes:

1. Most large water meters are Compound Type Meters.
2. Installation of a Turbine meter requires approval from the Water Systems Technician Supervisor.

This is from Leonard Wilson 8-25-2016, but it is not officially approved by the City yet.

APPENDIX C

**MANUFACTURER'S LITERATURE FOR A
REDUCED PRESSURE PRINCIPLE DETECTOR
CHECK ASSEMBLY BACKFLOW PREVENTER**

For Health Hazard Applications

Job Name _____

Contractor _____

Job Location _____

Approval _____

Engineer _____

Contractor's P.O. No. _____

Approval _____

Representative _____

Series 909RPDA

Reduced Pressure Detector Assemblies

Sizes: 2½" – 10" (65 – 250mm)

Series 909RPDA Reduced Pressure Detector Assemblies are used in health hazard applications and are designed exclusively for use in accordance with water utility authority containment requirements. It is mandatory to prevent the reverse flow of fire protection system substances, i.e., glycerin wetting agents, stagnant water and water of non-potable quality from being pumped or siphoned into the potable water line.

Benefits: Detects leaks . . . with emphasis on the cost of unaccountable water; incorporates a meter which allow the water utility to:

- detect leaks that historically create great annual cost due to waste
 - provide a detection point for unauthorized use. It can help locate illegal taps
- Modular check design concept facilitates maintenance and assembly access. All sizes are standardly equipped with AWWA epoxy coated, UL/FM listed OSY resilient seated gate valves, CFM (cubic feet per minute) or GPM (gallon per minute) meter and ball type test cocks. A pressure differential relief valve is located in a zone between the check valves.

Modular Design

Features a modular design concept which facilitates maintenance and assembly access. All sizes are standardly equipped with gate valves and ball type test cocks.

Features

- Body construction fused epoxy coated cast iron
- Replaceable bronze seats
- Maximum flow at low pressure drop
- Compact for economy combined with performance
- Design simplicity for easy maintenance
- Furnished with ⅝" x ¾" (16 x 19mm) meter
- Air-in/Water-out relief valve design provides maximum capacity during emergency conditions.
- No special tools required

Specifications

A Reduced Pressure Detector Assembly shall be installed on fire protection systems when connected to a public water supply. Degree of hazard present is determined by the local authority having jurisdiction. The unit shall be a complete assembly including UL listed and FM approved OSY shutoff valves. Including an auxiliary line consisting of an approved backflow preventer and water meter. The assembly shall meet the requirements of AWWA C511-92; ASSE 1047; UL Classified File No. EX3185; CSA B64 and USC Manual 8th. Edition. Assembly shall be a Watts Regulator Company Series 909RPDA.

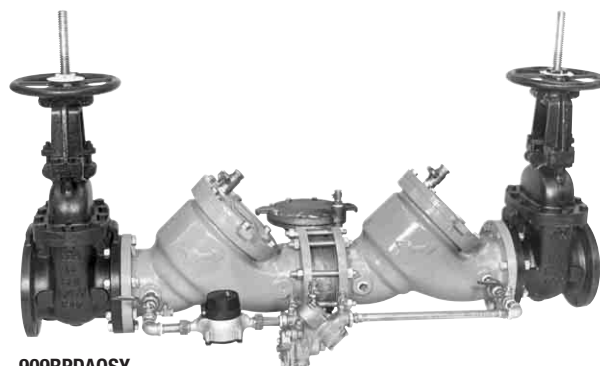

909RPDA0SY

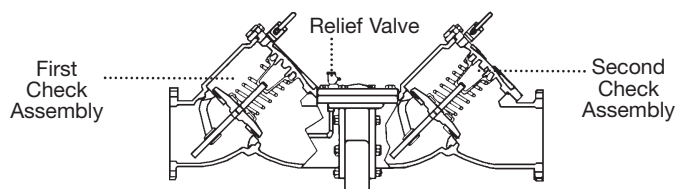

How it operates

The unique relief valve construction incorporates two channels: one for air, one for water. When the relief valve opens, as in the accompanying air-in/water-out diagram, the right-hand channel admits air to the top of the reduced pressure zone, relieving the zone vacuum. The channel on the left then drains the zone to atmosphere. Therefore, if both check valves foul, and simultaneous negative supply and positive backpressure develops, the relief valve uses the air-in/water-out principle to stop potential backflow.

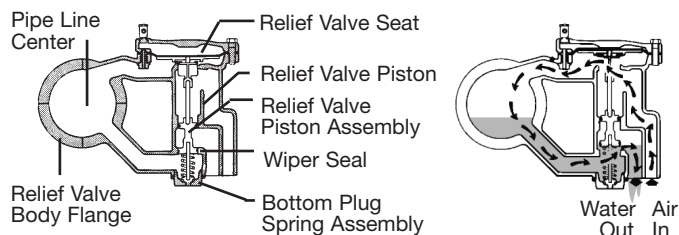

IMPORTANT: INQUIRE WITH GOVERNING AUTHORITIES FOR LOCAL INSTALLATION REQUIREMENTS

Now Available
WattsBox Insulated Enclosures.
 For more information, send for literature ES-WB.

Watts product specifications in U.S. customary units and metric are approximate and are provided for reference only. For precise measurements, please contact Watts Technical Service. Watts reserves the right to change or modify product design, construction, specifications, or materials without prior notice and without incurring any obligation to make such changes and modifications on Watts products previously or subsequently sold.

WATTS®

Models

Suffix:

- OSY – UL/FM outside stem and yoke resilient seated gate valves
- CFM – cubic feet per minute meter
- GPM – gallons per minute meter
- LF – less shutoff valves

Materials

- Discs: Rubber
- Body: Epoxy coated cast iron
- Seat and Disc Holder: Bronze
- Trim: Stainless steel
- Test Cocks: Bronze

Pressure – Temperature

- Temperature Range: 33°F – 140°F (0.5°C – 60°C) continuous
- Maximum Working Pressure: 175psi (12.1 bar)

Dimensions – Weights

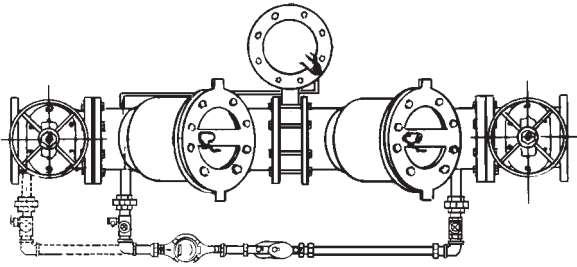

NOTE: Piping for 3" 909 will start from #1 gate valve and connect at #2 check valve.

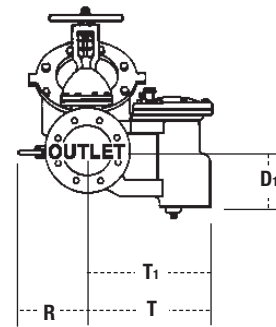
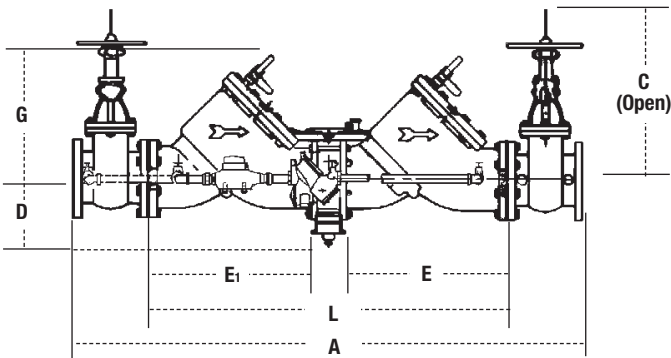

SIZE (DN)		DIMENSIONS										WEIGHT											
in.	mm	A		C		D		D1		E, E1		G		L		R		T		T1		lbs.	kgs.
		in.	mm	in.	mm	in.	mm	in.	mm	in.	mm	in.	mm	in.	mm	in.	mm	in.	mm	in.	mm		
2½	65	42⅞	1070	16⅜	416	5¼	133	4¼	114	12	305	7	178	26⅞	664	14	356	9	229	7⅝	194	230	104
3	80	42⅞	1070	18⅞	479	5¼	133	4¼	114	12	305	7	178	26⅞	664	14	356	9	229	7⅝	194	230	104
4	100	55½	1400	22¾	578	6	152	5⅞	149	17	432	9½	241	37	940	15	381	13⅝	346	11¾	299	470	213
6	150	66	1664	30⅞	765	6	152	6	152	20¾	527	14½	368	45	1130	16	406	13⅝	346	11¾	299	798	362
8	200	78½	1994	37¾	959	9¾	248	8⅝	219	26	660	18½	470	55¼	1403	17	432	18½	470	16⅜	416	1456	660
10	250	93⅝	2378	45¾	1162	9¾	248	8⅝	219	32	813	21½	546	67½	1715	18	457	18½	470	16⅜	416	2230	1012

Standards

- AWWA C511-92; CSA B64
- USC Manual for Cross-connection Control, 8th Edition

Approvals



Approved by the foundation for Cross-Connection Control and Hydraulic Research at the University of Southern California.

Series 909AG AIR GAPS

When installing a drain line, use Series 909 air gaps on Model 909 backflow preventers.

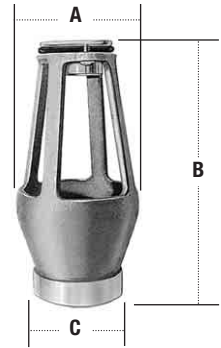

Iron Body Model	Ordering Code	Series/Sizes	Dimensions						Weight	
			A		B		C		lbs	kgs
			in.	mm	in.	mm	in.	mm		
909AG-F	0881378	1¼" – 3" 009/909								
		1¼" – 2" 009 M1	4⅜"	111	6¾"	171	2	51	3.25	1.47
		2" 009 M2								
909AG-K	0881385	4" – 6" 909	6⅞"	162	9⅞"	244	3	76	6.25	2.83
		8" – 10" 909 M1								
909AG-M	0881387	8" – 10" 909	7⅞"	187	11¼"	286	4	102	15.50	7.03

Capacity

*Typical maximum flow rate (7.5 feet/sec.) **UL rated flow

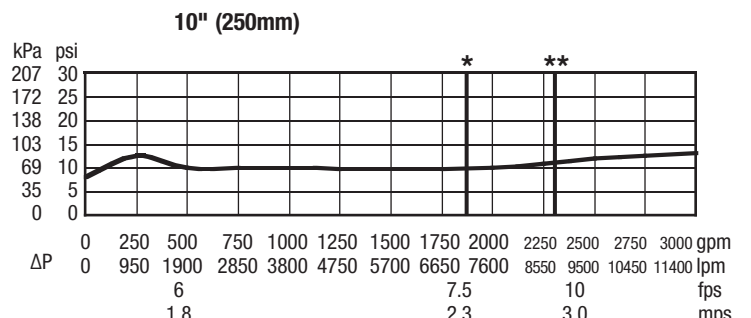
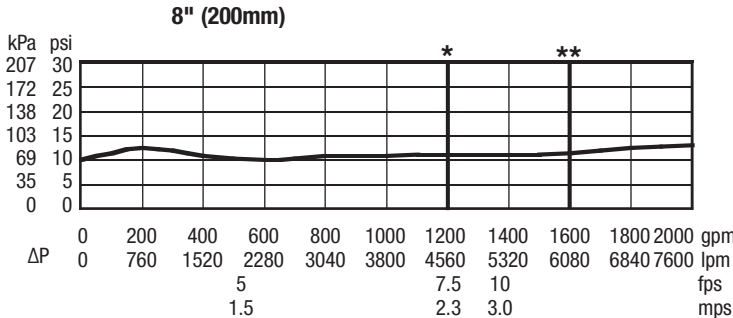
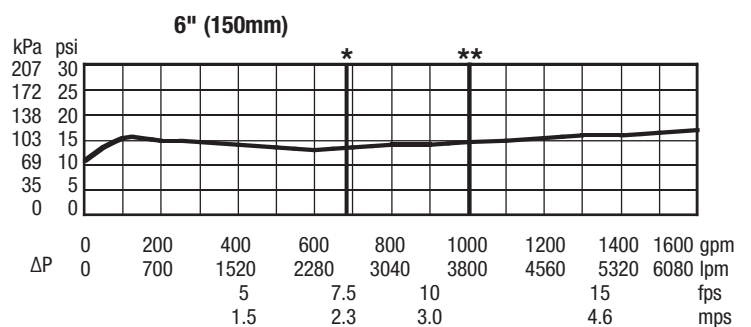
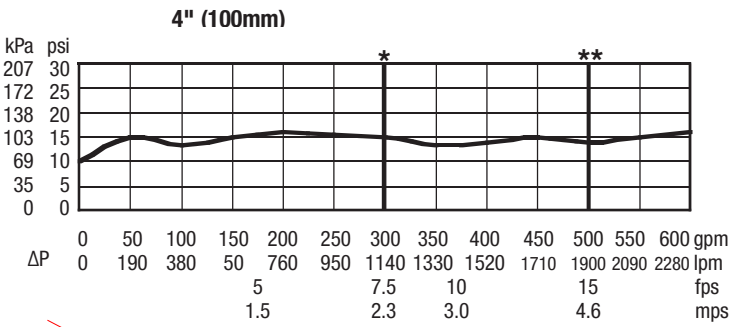
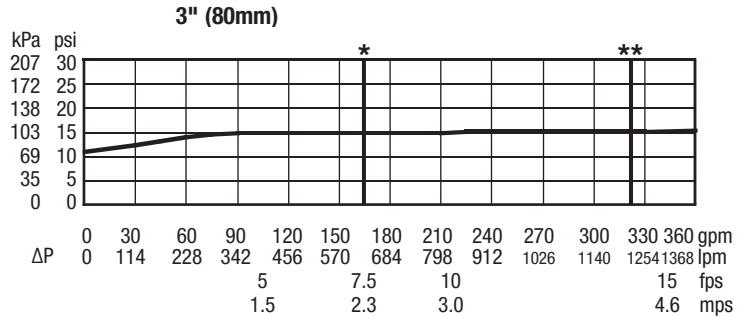
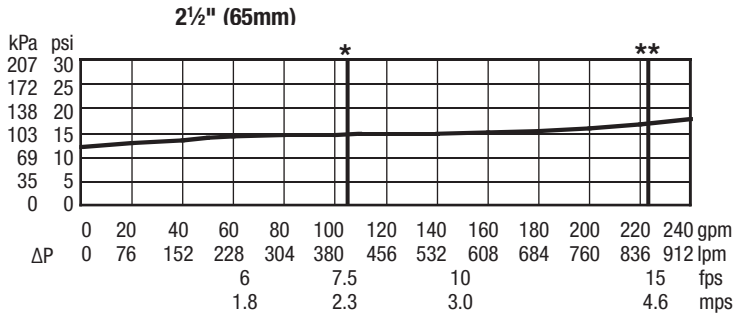

For additional information, visit our web site at: www.watts.com



A Watts Water Technologies Company

ES-909RPDA 1004



USA: 815 Chestnut St., No. Andover, MA 01845-6098; www.watts.com
Canada: 5435 North Service Rd., Burlington, ONT. L7L 5H7; www.wattscanada.ca

© 2010 Watts

APPENDIX D

COMPUTER HYDRAULIC MODEL RUNS

PRIVATE FIRE PROTECTION SYSTEM ANALYSIS

NODE AND PIPE DIAGRAM REFERENCE:

Exhibit A

CONDITIONS MODELED:

1. 1,500 gpm Fire Flow at Node 17
2. 1,500 gpm Fire Flow at Node 11
3. 1,500 gpm Fire Flow at Node 14
4. 1,500 gpm Fire Flow at Node 16
5. 1,500 gpm Fire Flow at Node 6
6. 1,500 gpm Fire Flow at Node 22
7. 1,500 gpm Fire Flow at Node 13
8. 3,000 gpm Fire Flow split between Node 11 and Node 16
9. 3,000 gpm Fire Flow split between Node 6 and Node 14

**Nakano (Dennergy Ranch)
City of Chula Vista/City of San Diego PUD
Computer Model**

**June 20, 2022
Dexter Wilson Eng., Inc.
Job 648-038**

```

* * * * * K Y P I P E * * * * *
*
* Pipe Network Modeling Software
*
* CopyRighted by KYPIPE LLC (www.kypipe.com)
* Version: 10.009 10/01/2019
* Company: Dexter Serial #: 592169
* Interface: Classic
* Licensed for Pipe2018
*
* * * * *

```

Date & Time: Mon Jun 20 17:13:38 2022

Master File : \\artic\eng\648038\nakano dennergy road ky pipe june 2022.KYP\nakano dennergy road ky pipe june 2022.P2K

SUMMARY OF ORIGINAL DATA

U N I T S S P E C I F I E D

FLOWRATE = gallons/minute
HEAD (HGL) = feet
PRESSURE = psig

P I P E L I N E D A T A

STATUS CODE: XX -CLOSED PIPE CV -CHECK VALVE

PIPE NAME	NODE #1	NODE #2	LENGTH (ft)	DIAMETER (in)	ROUGHNESS COEFF.	MINOR LOSS COEFF.
P-1	WRS-2	J-2	100.00	12.00	120.0000	0.00
P-2	J-3	WRS-1	60.00	12.00	120.0000	0.00
P-3	J-3	J-4	500.00	12.00	120.0000	0.00
P-4	J-4	J-18	60.00	12.00	120.0000	0.00
P-5	J-4	I-BF-2	60.00	8.00	120.0000	0.00
P-6	O-BF-2	J-9	153.70	8.00	120.0000	1.40
P-7	J-5	J-17	90.00	8.00	120.0000	1.00
P-9	J-8	J-6	450.00	8.00	120.0000	0.75
P-10	J-9	J-5	39.00	8.00	120.0000	1.00
P-11	J-9	J-11	460.00	8.00	120.0000	1.75
P-12	J-10	J-8	140.00	8.00	120.0000	1.40
P-13	J-10	J-12	460.00	8.00	120.0000	1.00
P-14	J-12	J-13	80.00	6.00	120.0000	1.75
P-16	O-BF-1	J-5	169.90	8.00	120.0000	1.40
P-17	J-21	J-29	180.00	8.00	120.0000	0.00
P-18	J-22	J-14	410.00	8.00	120.0000	0.00
P-19	J-10	J-16	70.00	8.00	120.0000	0.00
P-20	J-21	J-19	500.00	8.00	120.0000	1.00
P-21	J-1	J-3	1000.00	12.00	120.0000	0.00
P-22	J-2	J-1	1500.00	12.00	120.0000	0.00
P-23	J-18	I-BF-1	60.00	8.00	120.0000	0.00
P-24	J-19	J-17	70.00	8.00	120.0000	0.00
P-25	J-19	J-11	250.00	8.00	120.0000	1.40
P-26	J-29	J-6	80.00	8.00	120.0000	0.00

**Nakano (Dennerly Ranch)
City of Chula Vista/City of San Diego PUD
Computer Model**

**June 20, 2022
Dexter Wilson Eng., Inc.
Job 648-038**

P-27	J-20	J-29	500.00	8.00	120.0000	1.00
P-28	J-20	J-19	180.00	8.00	120.0000	1.00
P-29	J-20	J-12	640.00	8.00	120.0000	0.00
P-30	J-14	J-21	70.00	8.00	120.0000	0.40
P-31	J-16	J-20	80.00	8.00	120.0000	1.00
P-33	J-5	J-22	200.00	8.00	120.0000	0.00

P U M P / L O S S E L E M E N T D A T A

THERE IS A DEVICE AT NODE BF-1 DESCRIBED BY THE FOLLOWING DATA: (ID= 1)

HEAD (ft)	FLOWRATE (gpm)	EFFICIENCY (%)
-20.00	0.00	75.00 (Default)
-25.00	400.00	75.00 (Default)
-28.00	1200.00	75.00 (Default)
-30.00	1800.00	75.00 (Default)
-32.00	2100.00	75.00 (Default)

THERE IS A DEVICE AT NODE BF-2> (ID= 1)

N O D E D A T A

NODE NAME	NODE TITLE	EXTERNAL DEMAND (gpm)	JUNCTION ELEVATION (ft)	EXTERNAL GRADE (ft)
I-BF-1		0.00	195.00	
I-BF-2		0.00	195.00	
J-1		0.00	165.00	
J-2		0.00	157.00	
J-3		0.00	173.00	
J-4		0.00	195.00	
J-5		0.00	119.00	
J-6		0.00	113.00	
J-8		0.00	112.00	
J-9		0.00	119.00	
J-10		0.00	112.00	
J-11		0.00	116.00	
J-12		1.00	112.00	
J-13		0.00	112.00	
J-14		0.00	116.00	
J-16		0.00	113.00	
J-17		0.00	116.00	
J-18		137.00	195.00	
J-19		0.00	116.00	
J-20		0.00	116.00	
J-21		0.00	115.00	
J-22		0.00	119.00	
J-29		0.00	115.00	
WRS-1		----	0.00	341.00
WRS-2		----	0.00	341.00
O-BF-1		0.00	195.00	
O-BF-2		0.00	195.00	

O U T P U T O P T I O N D A T A

**Nakano (Dennerly Ranch)
 City of Chula Vista/City of San Diego PUD
 Computer Model**

**June 20, 2022
 Dexter Wilson Eng., Inc.
 Job 648-038**

OUTPUT SELECTION: ALL RESULTS ARE INCLUDED IN THE TABULATED OUTPUT
 MAXIMUM AND MINIMUM PRESSURES = 3
 MAXIMUM AND MINIMUM VELOCITIES = 3

S Y S T E M C O N F I G U R A T I O N

NUMBER OF PIPES (P) = 30
 NUMBER OF END NODES (J) = 23
 NUMBER OF PRIMARY LOOPS (L) = 6
 NUMBER OF SUPPLY NODES (F) = 2
 NUMBER OF SUPPLY ZONES (Z) = 1

=====
 Case: 1

C H A N G E S F O R N E X T S I M U L A T I O N (Change Number = 1)

**Nakano Project
 1,500 gpm Fire Flow Demand at Node 17**

JUNCTION DEMANDS CHANGED - PLEASE SEE RESULTS TABLE

RESULTS OBTAINED AFTER 6 TRIALS: ACCURACY = 0.47770E-07

P I P E L I N E R E S U L T S

STATUS CODE: XX -CLOSED PIPE CV -CHECK VALVE

P I P E N A M E	N O D E N U M B E R S		F L O W R A T E gpm	H E A D L O S S ft	M I N O R L O S S ft	L I N E V E L O . ft/s	H L + M L / 1 0 0 0 ft/f	H L / 1 0 0 0 ft/f
	#1	#2						
P-1	WRS-2	J-2	189.31	0.01	0.00	0.54	0.13	0.13
P-2	J-3	WRS-1	-1448.69	0.35	0.00	4.11	5.84	5.84
P-3	J-3	J-4	1638.00	3.67	0.00	4.65	7.34	7.34
P-4	J-4	J-18	885.92	0.14	0.00	2.51	2.35	2.35
P-5	J-4	I-BF-2	752.08	0.75	0.00	4.80	12.50	12.50
P-6	O-BF-2	J-9	752.08	1.92	0.50	4.80	15.76	12.50
P-7	J-5	J-17	917.11	1.62	0.53	5.85	23.96	18.05
P-9	J-8	J-6	-59.29	0.05	0.00	0.38	0.12	0.11
P-10	J-9	J-5	441.63	0.18	0.12	2.82	7.83	4.66
P-11	J-9	J-11	310.45	1.12	0.11	1.98	2.66	2.43
P-12	J-10	J-8	-59.29	0.02	0.00	0.38	0.14	0.11
P-13	J-10	J-12	16.13	0.00	0.00	0.10	0.01	0.01
P-14	J-12	J-13	0.00	0.00	0.00	0.00	0.00	0.00
P-16	O-BF-1	J-5	748.92	2.11	0.50	4.78	15.33	12.40
P-17	J-21	J-29	134.38	0.09	0.00	0.86	0.51	0.51
P-18	J-22	J-14	273.44	0.79	0.00	1.75	1.92	1.92
P-19	J-10	J-16	43.16	0.00	0.00	0.28	0.06	0.06
P-20	J-21	J-19	139.06	0.27	0.01	0.89	0.57	0.55
P-21	J-1	J-3	189.31	0.13	0.00	0.54	0.13	0.13
P-22	J-2	J-1	189.31	0.20	0.00	0.54	0.13	0.13
P-23	J-18	I-BF-1	748.92	0.74	0.00	4.78	12.40	12.40
P-24	J-19	J-17	582.89	0.55	0.00	3.72	7.80	7.80
P-25	J-19	J-11	-310.45	0.61	0.09	1.98	2.77	2.43
P-26	J-29	J-6	59.29	0.01	0.00	0.38	0.11	0.11
P-27	J-20	J-29	-75.09	0.09	0.00	0.48	0.18	0.18

**Nakano (Dennergy Ranch)
City of Chula Vista/City of San Diego PUD
Computer Model**

**June 20, 2022
Dexter Wilson Eng., Inc.
Job 648-038**

P-28	J-20	J-19	133.38	0.09	0.01	0.85	0.57	0.51
P-29	J-20	J-12	-15.13	0.01	0.00	0.10	0.01	0.01
P-30	J-14	J-21	273.44	0.13	0.02	1.75	2.19	1.92
P-31	J-16	J-20	43.16	0.01	0.00	0.28	0.08	0.06
P-33	J-5	J-22	273.44	0.38	0.00	1.75	1.92	1.92

P U M P / L O S S E L E M E N T R E S U L T S

NAME	FLOWRATE gpm	INLET HEAD ft	OUTLET HEAD ft	PUMP HEAD ft	EFFIC- ENCY %	USEFUL POWER Hp	INCREMENTL COST \$	TOTAL COST \$	#PUMPS PARALLEL	#PUMPS SERIES	NPSH Avail. ft	Case
BF-1	748.92	141.10	114.56	-26.5	75.00	-5.	0.1	0.2	**	**	173.9	1.0000
BF-2	752.08	141.23	114.68	-26.6	75.00	-5.	-0.2	-0.3	**	**	174.1	1.0000

N O D E R E S U L T S

NODE NAME	NODE TITLE	EXTERNAL DEMAND gpm	HYDRAULIC GRADE ft	NODE ELEVATION ft	PRESSURE HEAD ft	NODE PRESSURE psi
I-BF-1		0.00	336.10	195.00	141.10	61.14
I-BF-2		0.00	336.23	195.00	141.23	61.20
J-1		0.00	340.78	165.00	175.78	76.17
J-2		0.00	340.99	157.00	183.99	79.73
J-3		0.00	340.65	173.00	167.65	72.65
J-4		0.00	336.98	195.00	141.98	61.53
J-5		0.00	306.95	119.00	187.95	81.45
J-6		0.00	305.53	113.00	192.53	83.43
J-8		0.00	305.48	112.00	193.48	83.84
J-9		0.00	307.26	119.00	188.26	81.58
J-10		0.00	305.46	112.00	193.46	83.83
J-11		0.00	306.04	116.00	190.04	82.35
J-12		1.00	305.45	112.00	193.45	83.83
J-13		0.00	305.45	112.00	193.45	83.83
J-14		0.00	305.78	116.00	189.78	82.24
J-16		0.00	305.45	113.00	192.45	83.40
J-17		1500.00	304.80	116.00	188.80	81.81
J-18		137.00	336.84	195.00	141.84	61.46
J-19		0.00	305.34	116.00	189.34	82.05
J-20		0.00	305.45	116.00	189.45	82.09
J-21		0.00	305.63	115.00	190.63	82.61
J-22		0.00	306.57	119.00	187.57	81.28
J-29		0.00	305.54	115.00	190.54	82.57
WRS-1		----	341.00			
WRS-2		----	341.00			
O-BF-1		0.00	309.56	195.00	114.56	49.64
O-BF-2		0.00	309.68	195.00	114.68	49.70

M A X I M U M A N D M I N I M U M V A L U E S

P R E S S U R E S

JUNCTION NUMBER	MAXIMUM PRESSURES psi	JUNCTION NUMBER	MINIMUM PRESSURES psi
J-8	83.84	O-BF-1	49.64
J-10	83.83	O-BF-2	49.70
J-12	83.83	I-BF-1	61.14

**Nakano (Dennergy Ranch)
City of Chula Vista/City of San Diego PUD
Computer Model**

**June 20, 2022
Dexter Wilson Eng., Inc.
Job 648-038**

V E L O C I T I E S

PIPE NUMBER	MAXIMUM VELOCITY (ft/s)	PIPE NUMBER	MINIMUM VELOCITY (ft/s)
P-7	5.85	P-29	0.10
P-5	4.80	P-13	0.10
P-6	4.80	P-19	0.28

S U M M A R Y O F I N F L O W S A N D O U T F L O W S

(+) INFLOWS INTO THE SYSTEM FROM SUPPLY NODES
(-) OUTFLOWS FROM THE SYSTEM INTO SUPPLY NODES

NODE NAME	FLOWRATE gpm	NODE TITLE
WRS-1	1448.69	
WRS-2	189.31	

NET SYSTEM INFLOW = 1638.00
NET SYSTEM OUTFLOW = 0.00
NET SYSTEM DEMAND = 1638.00

=====
Case: 2

C H A N G E S F O R N E X T S I M U L A T I O N (Change Number = 2)

**Nakano Project
1,500 gpm Fire Flow Demand at Node 11**

JUNCTION DEMANDS CHANGED - PLEASE SEE RESULTS TABLE

RESULTS OBTAINED AFTER 4 TRIALS: ACCURACY = 0.34332E-05

P I P E L I N E R E S U L T S

STATUS CODE: XX -CLOSED PIPE CV -CHECK VALVE

P I P E N A M E	N O D E N U M B E R S		F L O W R A T E gpm	H E A D L O S S ft	M I N O R L O S S ft	L I N E V E L O . ft/s	H L + M L / 1000 ft/f	H L / 1000 ft/f
	#1	#2						
P-1	WRS-2	J-2	189.31	0.01	0.00	0.54	0.13	0.13
P-2	J-3	WRS-1	-1448.69	0.35	0.00	4.11	5.84	5.84
P-3	J-3	J-4	1638.00	3.67	0.00	4.65	7.34	7.34
P-4	J-4	J-18	873.61	0.14	0.00	2.48	2.29	2.29
P-5	J-4	I-BF-2	764.39	0.77	0.00	4.88	12.88	12.88
P-6	O-BF-2	J-9	764.39	1.98	0.52	4.88	16.25	12.88
P-7	J-5	J-17	558.45	0.65	0.20	3.56	9.39	7.20
P-9	J-8	J-6	-53.92	0.04	0.00	0.34	0.10	0.09
P-10	J-9	J-5	70.44	0.01	0.00	0.45	0.24	0.16
P-11	J-9	J-11	693.95	4.95	0.53	4.43	11.93	10.77
P-12	J-10	J-8	-53.92	0.01	0.00	0.34	0.11	0.09
P-13	J-10	J-12	14.70	0.00	0.00	0.09	0.01	0.01

**Nakano (Dennergy Ranch)
City of Chula Vista/City of San Diego PUD
Computer Model**

**June 20, 2022
Dexter Wilson Eng., Inc.
Job 648-038**

P-14	J-12	J-13	0.00	0.00	0.00	0.00	0.00	0.00
P-16	O-BF-1	J-5	736.61	2.04	0.48	4.70	14.86	12.03
P-17	J-21	J-29	122.19	0.08	0.00	0.78	0.43	0.43
P-18	J-22	J-14	248.60	0.66	0.00	1.59	1.61	1.61
P-19	J-10	J-16	39.22	0.00	0.00	0.25	0.05	0.05
P-20	J-21	J-19	126.40	0.23	0.01	0.81	0.48	0.46
P-21	J-1	J-3	189.31	0.13	0.00	0.54	0.13	0.13
P-22	J-2	J-1	189.31	0.20	0.00	0.54	0.13	0.13
P-23	J-18	I-BF-1	736.61	0.72	0.00	4.70	12.03	12.03
P-24	J-19	J-17	-558.45	0.50	0.00	3.56	7.20	7.20
P-25	J-19	J-11	806.05	3.55	0.58	5.14	16.51	14.21
P-26	J-29	J-6	53.92	0.01	0.00	0.34	0.09	0.09
P-27	J-20	J-29	-68.27	0.07	0.00	0.44	0.15	0.15
P-28	J-20	J-19	121.19	0.08	0.01	0.77	0.48	0.43
P-29	J-20	J-12	-13.70	0.00	0.00	0.09	0.01	0.01
P-30	J-14	J-21	248.60	0.11	0.02	1.59	1.83	1.61
P-31	J-16	J-20	39.22	0.00	0.00	0.25	0.06	0.05
P-33	J-5	J-22	248.60	0.32	0.00	1.59	1.61	1.61

P U M P / L O S S E L E M E N T R E S U L T S

NAME	FLOWRATE gpm	INLET HEAD ft	OUTLET HEAD ft	PUMP HEAD ft	EFFIC- ENCY %	USEFUL POWER Hp	INCREMTL COST \$	TOTAL COST \$	#PUMPS PARALLEL	#PUMPS SERIES	NPSH Avail. ft	Case
BF-1	736.61	141.12	114.63	-26.5	75.00	-5.	-0.2	-0.1	**	**	174.0	2.0000
BF-2	764.39	141.21	114.61	-26.6	75.00	-5.	-0.3	-0.6	**	**	174.0	2.0000

N O D E R E S U L T S

NODE NAME	NODE TITLE	EXTERNAL DEMAND gpm	HYDRAULIC GRADE ft	NODE ELEVATION ft	PRESSURE HEAD ft	NODE PRESSURE psi
I-BF-1		0.00	336.12	195.00	141.12	61.15
I-BF-2		0.00	336.21	195.00	141.21	61.19
J-1		0.00	340.78	165.00	175.78	76.17
J-2		0.00	340.99	157.00	183.99	79.73
J-3		0.00	340.65	173.00	167.65	72.65
J-4		0.00	336.98	195.00	141.98	61.53
J-5		0.00	307.11	119.00	188.11	81.51
J-6		0.00	305.91	113.00	192.91	83.59
J-8		0.00	305.87	112.00	193.87	84.01
J-9		0.00	307.12	119.00	188.12	81.52
J-10		0.00	305.85	112.00	193.85	84.00
J-11		1500.00	301.63	116.00	185.63	80.44
J-12		1.00	305.85	112.00	193.85	84.00
J-13		0.00	305.85	112.00	193.85	84.00
J-14		0.00	306.12	116.00	190.12	82.39
J-16		0.00	305.85	113.00	192.85	83.57
J-17		0.00	306.26	116.00	190.26	82.45
J-18		137.00	336.84	195.00	141.84	61.47
J-19		0.00	305.76	116.00	189.76	82.23
J-20		0.00	305.84	116.00	189.84	82.27
J-21		0.00	306.00	115.00	191.00	82.77
J-22		0.00	306.78	119.00	187.78	81.37
J-29		0.00	305.92	115.00	190.92	82.73
WRS-1		----	341.00			
WRS-2		----	341.00			
O-BF-1		0.00	309.63	195.00	114.63	49.67
O-BF-2		0.00	309.61	195.00	114.61	49.67

**Nakano (Dennergy Ranch)
City of Chula Vista/City of San Diego PUD
Computer Model**

**June 20, 2022
Dexter Wilson Eng., Inc.
Job 648-038**

M A X I M U M A N D M I N I M U M V A L U E S

P R E S S U R E S

JUNCTION NUMBER	MAXIMUM PRESSURES psi	JUNCTION NUMBER	MINIMUM PRESSURES psi
J-8	84.01	O-BF-2	49.67
J-10	84.00	O-BF-1	49.67
J-12	84.00	I-BF-1	61.15

V E L O C I T I E S

PIPE NUMBER	MAXIMUM VELOCITY (ft/s)	PIPE NUMBER	MINIMUM VELOCITY (ft/s)
P-25	5.14	P-29	0.09
P-5	4.88	P-13	0.09
P-6	4.88	P-19	0.25

S U M M A R Y O F I N F L O W S A N D O U T F L O W S

(+) INFLOWS INTO THE SYSTEM FROM SUPPLY NODES
(-) OUTFLOWS FROM THE SYSTEM INTO SUPPLY NODES

NODE NAME	FLOWRATE gpm	NODE TITLE
WRS-1	1448.69	
WRS-2	189.31	

NET SYSTEM INFLOW = 1638.00
NET SYSTEM OUTFLOW = 0.00
NET SYSTEM DEMAND = 1638.00

=====
Case: 3

C H A N G E S F O R N E X T S I M U L A T I O N (Change Number = 3)

**Nakano Project
1,500 gpm Fire Flow Demand at Node 14**

JUNCTION DEMANDS CHANGED - PLEASE SEE RESULTS TABLE

RESULTS OBTAINED AFTER 5 TRIALS: ACCURACY = 0.45052E-06

P I P E L I N E R E S U L T S

STATUS CODE: **XX -CLOSED PIPE** **CV -CHECK VALVE**

P I P E N A M E	N O D E N U M B E R S		F L O W R A T E gpm	H E A D L O S S ft	M I N O R L O S S ft	L I N E V E L O . ft/s	H L + M L / 1 0 0 0 ft/f	H L / 1 0 0 0 ft/f
	#1	#2						
P-1	WRS-2	J-2	189.31	0.01	0.00	0.54	0.13	0.13
P-2	J-3	WRS-1	-1448.69	0.35	0.00	4.11	5.84	5.84
P-3	J-3	J-4	1638.00	3.67	0.00	4.65	7.34	7.34

**Nakano (Dennergy Ranch)
City of Chula Vista/City of San Diego PUD
Computer Model**

**June 20, 2022
Dexter Wilson Eng., Inc.
Job 648-038**

P-4	J-4	J-18	886.56	0.14	0.00	2.51	2.35	2.35
P-5	J-4	I-BF-2	751.44	0.75	0.00	4.80	12.48	12.48
P-6	O-BF-2	J-9	751.44	1.92	0.50	4.80	15.73	12.48
P-7	J-5	J-17	581.88	0.70	0.21	3.71	10.15	7.77
P-9	J-8	J-6	189.74	0.44	0.02	1.21	1.01	0.98
P-10	J-9	J-5	453.14	0.19	0.13	2.89	8.22	4.89
P-11	J-9	J-11	298.30	1.04	0.10	1.90	2.47	2.25
P-12	J-10	J-8	189.74	0.14	0.03	1.21	1.20	0.98
P-13	J-10	J-12	-50.22	0.04	0.00	0.32	0.09	0.08
P-14	J-12	J-13	0.00	0.00	0.00	0.00	0.00	0.00
P-16	O-BF-1	J-5	749.56	2.11	0.50	4.78	15.35	12.42
P-17	J-21	J-29	-430.96	0.80	0.00	2.75	4.46	4.46
P-18	J-22	J-14	620.82	3.59	0.00	3.96	8.76	8.76
P-19	J-10	J-16	-139.52	0.04	0.00	0.89	0.55	0.55
P-20	J-21	J-19	-448.22	2.40	0.13	2.86	5.05	4.79
P-21	J-1	J-3	189.31	0.13	0.00	0.54	0.13	0.13
P-22	J-2	J-1	189.31	0.20	0.00	0.54	0.13	0.13
P-23	J-18	I-BF-1	749.56	0.75	0.00	4.78	12.42	12.42
P-24	J-19	J-17	-581.88	0.54	0.00	3.71	7.77	7.77
P-25	J-19	J-11	-298.30	0.56	0.08	1.90	2.57	2.25
P-26	J-29	J-6	-189.74	0.08	0.00	1.21	0.98	0.98
P-27	J-20	J-29	241.22	0.76	0.04	1.54	1.60	1.52
P-28	J-20	J-19	-431.96	0.81	0.12	2.76	5.13	4.48
P-29	J-20	J-12	51.22	0.06	0.00	0.33	0.09	0.09
P-30	J-14	J-21	-879.18	1.17	0.20	5.61	19.49	16.69
P-31	J-16	J-20	-139.52	0.04	0.01	0.89	0.71	0.55
P-33	J-5	J-22	620.82	1.75	0.00	3.96	8.76	8.76

P U M P / L O S S E L E M E N T R E S U L T S

NAME	FLOWRATE gpm	INLET HEAD ft	OUTLET HEAD ft	PUMP HEAD ft	EFFIC- ENCY %	USEFUL POWER Hp	INCREMENTL COST \$	TOTAL COST \$	#PUMPS PARALLEL	#PUMPS SERIES	NPSH Avail. ft	Case
BF-1	749.56	141.10	114.55	-26.5	75.00	-5.	-0.2	-0.3	**	**	173.9	3.0000
BF-2	751.44	141.23	114.68	-26.5	75.00	-5.	-0.3	-0.8	**	**	174.1	3.0000

N O D E R E S U L T S

NODE NAME	NODE TITLE	EXTERNAL DEMAND gpm	HYDRAULIC GRADE ft	NODE ELEVATION ft	PRESSURE HEAD ft	NODE PRESSURE psi
I-BF-1		0.00	336.10	195.00	141.10	61.14
I-BF-2		0.00	336.23	195.00	141.23	61.20
J-1		0.00	340.78	165.00	175.78	76.17
J-2		0.00	340.99	157.00	183.99	79.73
J-3		0.00	340.65	173.00	167.65	72.65
J-4		0.00	336.98	195.00	141.98	61.53
J-5		0.00	306.95	119.00	187.95	81.44
J-6		0.00	303.84	113.00	190.84	82.70
J-8		0.00	304.30	112.00	192.30	83.33
J-9		0.00	307.27	119.00	188.27	81.58
J-10		0.00	304.47	112.00	192.47	83.40
J-11		0.00	306.13	116.00	190.13	82.39
J-12		1.00	304.51	112.00	192.51	83.42
J-13		0.00	304.51	112.00	192.51	83.42
J-14		1500.00	301.60	116.00	185.60	80.43
J-16		0.00	304.51	113.00	191.51	82.99
J-17		0.00	306.03	116.00	190.03	82.35
J-18		137.00	336.84	195.00	141.84	61.46

**Nakano (Dennergy Ranch)
City of Chula Vista/City of San Diego PUD
Computer Model**

**June 20, 2022
Dexter Wilson Eng., Inc.
Job 648-038**

J-19	0.00	305.49	116.00	189.49	82.11
J-20	0.00	304.56	116.00	188.56	81.71
J-21	0.00	302.96	115.00	187.96	81.45
J-22	0.00	305.19	119.00	186.19	80.68
J-29	0.00	303.77	115.00	188.77	81.80
WRS-1	----	341.00			
WRS-2	----	341.00			
O-BF-1	0.00	309.55	195.00	114.55	49.64
O-BF-2	0.00	309.68	195.00	114.68	49.70

M A X I M U M A N D M I N I M U M V A L U E S

P R E S S U R E S

JUNCTION NUMBER	MAXIMUM PRESSURES psi	JUNCTION NUMBER	MINIMUM PRESSURES psi
J-12	83.42	O-BF-1	49.64
J-13	83.42	O-BF-2	49.70
J-10	83.40	I-BF-1	61.14

V E L O C I T I E S

PIPE NUMBER	MAXIMUM VELOCITY (ft/s)	PIPE NUMBER	MINIMUM VELOCITY (ft/s)
P-30	5.61	P-13	0.32
P-5	4.80	P-29	0.33
P-6	4.80	P-1	0.54

S U M M A R Y O F I N F L O W S A N D O U T F L O W S

(+) INFLOWS INTO THE SYSTEM FROM SUPPLY NODES
(-) OUTFLOWS FROM THE SYSTEM INTO SUPPLY NODES

NODE NAME	FLOWRATE gpm	NODE TITLE
WRS-1	1448.69	
WRS-2	189.31	

NET SYSTEM INFLOW = 1638.00
NET SYSTEM OUTFLOW = 0.00
NET SYSTEM DEMAND = 1638.00

=====
Case: 4

C H A N G E S F O R N E X T S I M U L A T I O N (Change Number = 4)

**Nakano Project
1,500 gpm Fire Flow Demand at Node 16**

JUNCTION DEMANDS CHANGED - PLEASE SEE RESULTS TABLE

RESULTS OBTAINED AFTER 5 TRIALS: ACCURACY = 0.74646E-07

**Nakano (Dennergy Ranch)
City of Chula Vista/City of San Diego PUD
Computer Model**

**June 20, 2022
Dexter Wilson Eng., Inc.
Job 648-038**

PIPELINE RESULTS

STATUS CODE: XX -CLOSED PIPE CV -CHECK VALVE

PIPE NAME	NODE NUMBERS		FLOWRATE gpm	HEAD LOSS ft	MINOR LOSS ft	LINE VELO. ft/s	HL+ML/ 1000 ft/f	HL/ 1000 ft/f
	#1	#2						
P-1	WRS-2	J-2	189.31	0.01	0.00	0.54	0.13	0.13
P-2	J-3	WRS-1	-1448.69	0.35	0.00	4.11	5.84	5.84
P-3	J-3	J-4	1638.00	3.67	0.00	4.65	7.34	7.34
P-4	J-4	J-18	883.67	0.14	0.00	2.51	2.34	2.34
P-5	J-4	I-BF-2	754.33	0.75	0.00	4.81	12.57	12.57
P-6	O-BF-2	J-9	754.33	1.93	0.50	4.81	15.85	12.57
P-7	J-5	J-17	727.76	1.06	0.33	4.64	15.48	11.76
P-9	J-8	J-6	-368.11	1.50	0.06	2.35	3.47	3.33
P-10	J-9	J-5	398.78	0.15	0.10	2.55	6.44	3.86
P-11	J-9	J-11	355.55	1.44	0.14	2.27	3.43	3.12
P-12	J-10	J-8	-368.11	0.47	0.12	2.35	4.19	3.33
P-13	J-10	J-12	-217.26	0.58	0.03	1.39	1.32	1.25
P-14	J-12	J-13	0.00	0.00	0.00	0.00	0.00	0.00
P-16	O-BF-1	J-5	746.67	2.10	0.49	4.77	15.24	12.33
P-17	J-21	J-29	640.36	1.67	0.00	4.09	9.28	9.28
P-18	J-22	J-14	417.68	1.72	0.00	2.67	4.21	4.21
P-19	J-10	J-16	585.38	0.55	0.00	3.74	7.86	7.86
P-20	J-21	J-19	-222.68	0.66	0.03	1.42	1.37	1.31
P-21	J-1	J-3	189.31	0.13	0.00	0.54	0.13	0.13
P-22	J-2	J-1	189.31	0.20	0.00	0.54	0.13	0.13
P-23	J-18	I-BF-1	746.67	0.74	0.00	4.77	12.33	12.33
P-24	J-19	J-17	-727.76	0.82	0.00	4.64	11.76	11.76
P-25	J-19	J-11	-355.55	0.78	0.11	2.27	3.57	3.12
P-26	J-29	J-6	368.11	0.27	0.00	2.35	3.33	3.33
P-27	J-20	J-29	-272.25	0.95	0.05	1.74	2.00	1.90
P-28	J-20	J-19	-860.64	2.89	0.47	5.49	18.65	16.05
P-29	J-20	J-12	218.26	0.81	0.00	1.39	1.26	1.26
P-30	J-14	J-21	417.68	0.29	0.04	2.67	4.84	4.21
P-31	J-16	J-20	-914.62	1.44	0.53	5.84	24.57	17.96
P-33	J-5	J-22	417.68	0.84	0.00	2.67	4.21	4.21

PUMP/LOSS ELEMENT RESULTS

NAME	FLOWRATE gpm	INLET HEAD ft	OUTLET HEAD ft	PUMP HEAD ft	EFFIC- ENCY %	USEFUL POWER Hp	INCREMTL COST \$	TOTAL COST \$	#PUMPS PARALLEL	#PUMPS SERIES	NPSH Avail. ft	Case
BF-1	746.67	141.10	114.57	-26.5	75.00	-5.	-0.2	-0.6	**	**	173.9	4.0000
BF-2	754.33	141.23	114.67	-26.6	75.00	-5.	-0.3	-1.1	**	**	174.1	4.0000

NODE RESULTS

NODE NAME	NODE TITLE	EXTERNAL DEMAND gpm	HYDRAULIC GRADE ft	NODE ELEVATION ft	PRESSURE HEAD ft	NODE PRESSURE psi
I-BF-1		0.00	336.10	195.00	141.10	61.14
I-BF-2		0.00	336.23	195.00	141.23	61.20
J-1		0.00	340.78	165.00	175.78	76.17
J-2		0.00	340.99	157.00	183.99	79.73
J-3		0.00	340.65	173.00	167.65	72.65
J-4		0.00	336.98	195.00	141.98	61.53

**Nakano (Dennergy Ranch)
City of Chula Vista/City of San Diego PUD
Computer Model**

**June 20, 2022
Dexter Wilson Eng., Inc.
Job 648-038**

J-5	0.00	306.98	119.00	187.98	81.46
J-6	0.00	302.14	113.00	189.14	81.96
J-8	0.00	300.58	112.00	188.58	81.72
J-9	0.00	307.23	119.00	188.23	81.57
J-10	0.00	299.99	112.00	187.99	81.46
J-11	0.00	305.66	116.00	189.66	82.18
J-12	1.00	300.60	112.00	188.60	81.73
J-13	0.00	300.60	112.00	188.60	81.73
J-14	0.00	304.42	116.00	188.42	81.65
J-16	1500.00	299.44	113.00	186.44	80.79
J-17	0.00	305.59	116.00	189.59	82.15
J-18	137.00	336.84	195.00	141.84	61.46
J-19	0.00	304.76	116.00	188.76	81.80
J-20	0.00	301.41	116.00	185.41	80.34
J-21	0.00	304.08	115.00	189.08	81.93
J-22	0.00	306.14	119.00	187.14	81.09
J-29	0.00	302.41	115.00	187.41	81.21
WRS-1	----	341.00			
WRS-2	----	341.00			
O-BF-1	0.00	309.57	195.00	114.57	49.65
O-BF-2	0.00	309.67	195.00	114.67	49.69

M A X I M U M A N D M I N I M U M V A L U E S

P R E S S U R E S

JUNCTION NUMBER	MAXIMUM PRESSURES psi	JUNCTION NUMBER	MINIMUM PRESSURES psi
J-11	82.18	O-BF-1	49.65
J-17	82.15	O-BF-2	49.69
J-6	81.96	I-BF-1	61.14

V E L O C I T I E S

PIPE NUMBER	MAXIMUM VELOCITY (ft/s)	PIPE NUMBER	MINIMUM VELOCITY (ft/s)
P-31	5.84	P-1	0.54
P-28	5.49	P-21	0.54
P-5	4.81	P-22	0.54

S U M M A R Y O F I N F L O W S A N D O U T F L O W S

(+) INFLOWS INTO THE SYSTEM FROM SUPPLY NODES
(-) OUTFLOWS FROM THE SYSTEM INTO SUPPLY NODES

NODE NAME	FLOWRATE gpm	NODE TITLE
WRS-1	1448.69	
WRS-2	189.31	

NET SYSTEM INFLOW = 1638.00
NET SYSTEM OUTFLOW = 0.00
NET SYSTEM DEMAND = 1638.00

**Nakano (Dennergy Ranch)
City of Chula Vista/City of San Diego PUD
Computer Model**

**June 20, 2022
Dexter Wilson Eng., Inc.
Job 648-038**

=====
Case: 5

C H A N G E S F O R N E X T S I M U L A T I O N (Change Number = 5)

**Nakano Project
1,500 gpm Fire Flow Demand at Node 6**

JUNCTION DEMANDS CHANGED - PLEASE SEE RESULTS TABLE

RESULTS OBTAINED AFTER 5 TRIALS: ACCURACY = 0.92227E-07

P I P E L I N E R E S U L T S

STATUS CODE: XX -CLOSED PIPE CV -CHECK VALVE

P I P E N A M E	N O D E N U M B E R S		F L O W R A T E gpm	H E A D L O S S ft	M I N O R L O S S ft	L I N E V E L O . ft/s	H L + M L / 1000 ft/f	H L / 1000 ft/f
	#1	#2						
P-1	WRS-2	J-2	189.31	0.01	0.00	0.54	0.13	0.13
P-2	J-3	WRS-1	-1448.69	0.35	0.00	4.11	5.84	5.84
P-3	J-3	J-4	1638.00	3.67	0.00	4.65	7.34	7.34
P-4	J-4	J-18	884.18	0.14	0.00	2.51	2.34	2.34
P-5	J-4	I-BF-2	753.82	0.75	0.00	4.81	12.55	12.55
P-6	O-BF-2	J-9	753.82	1.93	0.50	4.81	15.83	12.55
P-7	J-5	J-17	701.35	0.99	0.31	4.48	14.44	10.98
P-9	J-8	J-6	421.67	1.93	0.08	2.69	4.47	4.28
P-10	J-9	J-5	408.90	0.16	0.11	2.61	6.76	4.04
P-11	J-9	J-11	344.91	1.36	0.13	2.20	3.24	2.95
P-12	J-10	J-8	421.67	0.60	0.16	2.69	5.41	4.28
P-13	J-10	J-12	-112.75	0.17	0.01	0.72	0.39	0.37
P-14	J-12	J-13	0.00	0.00	0.00	0.00	0.00	0.00
P-16	O-BF-1	J-5	747.18	2.10	0.49	4.77	15.26	12.35
P-17	J-21	J-29	772.53	2.36	0.00	4.93	13.14	13.14
P-18	J-22	J-14	454.74	2.02	0.00	2.90	4.92	4.92
P-19	J-10	J-16	-308.92	0.17	0.00	1.97	2.41	2.41
P-20	J-21	J-19	-317.79	1.27	0.06	2.03	2.66	2.54
P-21	J-1	J-3	189.31	0.13	0.00	0.54	0.13	0.13
P-22	J-2	J-1	189.31	0.20	0.00	0.54	0.13	0.13
P-23	J-18	I-BF-1	747.18	0.74	0.00	4.77	12.35	12.35
P-24	J-19	J-17	-701.35	0.77	0.00	4.48	10.98	10.98
P-25	J-19	J-11	-344.91	0.74	0.11	2.20	3.37	2.95
P-26	J-29	J-6	1078.33	1.95	0.00	6.88	24.36	24.36
P-27	J-20	J-29	305.80	1.18	0.06	1.95	2.48	2.36
P-28	J-20	J-19	-728.47	2.12	0.34	4.65	13.65	11.78
P-29	J-20	J-12	113.75	0.24	0.00	0.73	0.38	0.38
P-30	J-14	J-21	454.74	0.34	0.05	2.90	5.67	4.92
P-31	J-16	J-20	-308.92	0.19	0.06	1.97	3.16	2.41
P-33	J-5	J-22	454.74	0.98	0.00	2.90	4.92	4.92

P U M P / L O S S E L E M E N T R E S U L T S

NAME	FLOWRATE gpm	INLET HEAD ft	OUTLET HEAD ft	PUMP HEAD ft	EFFIC- ENCY %	USEFUL POWER Hp	INCREMENTL COST \$	TOTAL COST \$	#PUMPS PARALLEL	#PUMPS SERIES	NPSH Avail. ft	Case
BF-1	747.18	141.10	114.57	-26.5	75.00	-5.	-0.2	-0.8	**	**	173.9	5.0000
BF-2	753.82	141.23	114.67	-26.6	75.00	-5.	-0.3	-1.3	**	**	174.1	5.0000

**Nakano (Dennergy Ranch)
City of Chula Vista/City of San Diego PUD
Computer Model**

**June 20, 2022
Dexter Wilson Eng., Inc.
Job 648-038**

N O D E R E S U L T S

NODE NAME	NODE TITLE	EXTERNAL DEMAND gpm	HYDRAULIC GRADE ft	NODE ELEVATION ft	PRESSURE HEAD ft	NODE PRESSURE psi
I-BF-1		0.00	336.10	195.00	141.10	61.14
I-BF-2		0.00	336.23	195.00	141.23	61.20
J-1		0.00	340.78	165.00	175.78	76.17
J-2		0.00	340.99	157.00	183.99	79.73
J-3		0.00	340.65	173.00	167.65	72.65
J-4		0.00	336.98	195.00	141.98	61.53
J-5		0.00	306.98	119.00	187.98	81.46
J-6		1500.00	299.26	113.00	186.26	80.71
J-8		0.00	301.27	112.00	189.27	82.02
J-9		0.00	307.24	119.00	188.24	81.57
J-10		0.00	302.03	112.00	190.03	82.35
J-11		0.00	305.75	116.00	189.75	82.22
J-12		1.00	302.21	112.00	190.21	82.42
J-13		0.00	302.21	112.00	190.21	82.42
J-14		0.00	303.97	116.00	187.97	81.45
J-16		0.00	302.20	113.00	189.20	81.99
J-17		0.00	305.68	116.00	189.68	82.19
J-18		137.00	336.84	195.00	141.84	61.46
J-19		0.00	304.91	116.00	188.91	81.86
J-20		0.00	302.45	116.00	186.45	80.80
J-21		0.00	303.58	115.00	188.58	81.72
J-22		0.00	305.99	119.00	186.99	81.03
J-29		0.00	301.21	115.00	186.21	80.69
WRS-1		----	341.00			
WRS-2		----	341.00			
O-BF-1		0.00	309.57	195.00	114.57	49.65
O-BF-2		0.00	309.67	195.00	114.67	49.69

M A X I M U M A N D M I N I M U M V A L U E S

P R E S S U R E S

JUNCTION NUMBER	MAXIMUM PRESSURES psi	JUNCTION NUMBER	MINIMUM PRESSURES psi
J-12	82.42	O-BF-1	49.65
J-13	82.42	O-BF-2	49.69
J-10	82.35	I-BF-1	61.14

V E L O C I T I E S

PIPE NUMBER	MAXIMUM VELOCITY (ft/s)	PIPE NUMBER	MINIMUM VELOCITY (ft/s)
P-26	6.88	P-1	0.54
P-17	4.93	P-21	0.54
P-5	4.81	P-22	0.54

S U M M A R Y O F I N F L O W S A N D O U T F L O W S

- (+) INFLOWS INTO THE SYSTEM FROM SUPPLY NODES
- (-) OUTFLOWS FROM THE SYSTEM INTO SUPPLY NODES

**Nakano (Dennergy Ranch)
City of Chula Vista/City of San Diego PUD
Computer Model**

**June 20, 2022
Dexter Wilson Eng., Inc.
Job 648-038**

NODE NAME	FLOWRATE gpm	NODE TITLE
WRS-1	1448.69	
WRS-2	189.31	

NET SYSTEM INFLOW = 1638.00
NET SYSTEM OUTFLOW = 0.00
NET SYSTEM DEMAND = 1638.00

=====
Case: 6

C H A N G E S F O R N E X T S I M U L A T I O N (Change Number = 6)

**Nakano Project
1,500 gpm Fire Flow Demand at Node 22**

JUNCTION DEMANDS CHANGED - PLEASE SEE RESULTS TABLE

RESULTS OBTAINED AFTER 5 TRIALS: ACCURACY = 0.36810E-04

P I P E L I N E R E S U L T S

STATUS CODE: XX -CLOSED PIPE CV -CHECK VALVE

P I P E N A M E	NODE NUMBERS		FLOWRATE gpm	HEAD LOSS ft	MINOR LOSS ft	LINE VELO. ft/s	HL+ML/ 1000 ft/f	HL/ 1000 ft/f
	#1	#2						
P-1	WRS-2	J-2	189.31	0.01	0.00	0.54	0.13	0.13
P-2	J-3	WRS-1	-1448.69	0.35	0.00	4.11	5.84	5.84
P-3	J-3	J-4	1638.00	3.67	0.00	4.65	7.34	7.34
P-4	J-4	J-18	892.02	0.14	0.00	2.53	2.38	2.38
P-5	J-4	I-BF-2	745.98	0.74	0.00	4.76	12.31	12.31
P-6	O-BF-2	J-9	745.98	1.89	0.49	4.76	15.52	12.31
P-7	J-5	J-17	299.69	0.20	0.06	1.91	2.91	2.27
P-9	J-8	J-6	108.48	0.16	0.01	0.69	0.36	0.35
P-10	J-9	J-5	542.26	0.27	0.19	3.46	11.59	6.82
P-11	J-9	J-11	203.71	0.51	0.05	1.30	1.21	1.11
P-12	J-10	J-8	108.48	0.05	0.01	0.69	0.42	0.35
P-13	J-10	J-12	-28.43	0.01	0.00	0.18	0.03	0.03
P-14	J-12	J-13	0.00	0.00	0.00	0.00	0.00	0.00
P-16	O-BF-1	J-5	755.02	2.14	0.50	4.82	15.56	12.59
P-17	J-21	J-29	-246.27	0.28	0.00	1.57	1.58	1.58
P-18	J-22	J-14	-502.41	2.43	0.00	3.21	5.92	5.92
P-19	J-10	J-16	-80.05	0.01	0.00	0.51	0.20	0.20
P-20	J-21	J-19	-256.14	0.85	0.04	1.63	1.78	1.70
P-21	J-1	J-3	189.31	0.13	0.00	0.54	0.13	0.13
P-22	J-2	J-1	189.31	0.20	0.00	0.54	0.13	0.13
P-23	J-18	I-BF-1	755.02	0.76	0.00	4.82	12.59	12.59
P-24	J-19	J-17	-299.69	0.16	0.00	1.91	2.27	2.27
P-25	J-19	J-11	-203.71	0.28	0.04	1.30	1.26	1.11
P-26	J-29	J-6	-108.48	0.03	0.00	0.69	0.35	0.35
P-27	J-20	J-29	137.79	0.27	0.01	0.88	0.56	0.54
P-28	J-20	J-19	-247.27	0.29	0.04	1.58	1.81	1.59
P-29	J-20	J-12	29.43	0.02	0.00	0.19	0.03	0.03
P-30	J-14	J-21	-502.41	0.41	0.06	3.21	6.83	5.92
P-31	J-16	J-20	-80.05	0.02	0.00	0.51	0.25	0.20
P-33	J-5	J-22	997.59	4.22	0.00	6.37	21.09	21.09

**Nakano (Dennergy Ranch)
City of Chula Vista/City of San Diego PUD
Computer Model**

**June 20, 2022
Dexter Wilson Eng., Inc.
Job 648-038**

P U M P / L O S S E L E M E N T R E S U L T S

NAME	FLOWRATE gpm	INLET HEAD ft	OUTLET HEAD ft	PUMP HEAD ft	EFFIC- ENCY %	USEFUL POWER Hp	INCREMENTL COST \$	TOTAL COST \$	#PUMPS PARALLEL	#PUMPS SERIES	NPSH Avail. ft	Case
BF-1	755.02	141.08	114.52	-26.6	75.00	-5.	-0.2	-1.1	**	**	173.9	6.0000
BF-2	745.98	141.24	114.72	-26.5	75.00	-5.	-0.3	-1.6	**	**	174.1	6.0000

N O D E R E S U L T S

NODE NAME	NODE TITLE	EXTERNAL DEMAND gpm	HYDRAULIC GRADE ft	NODE ELEVATION ft	PRESSURE HEAD ft	NODE PRESSURE psi
I-BF-1		0.00	336.08	195.00	141.08	61.14
I-BF-2		0.00	336.24	195.00	141.24	61.21
J-1		0.00	340.78	165.00	175.78	76.17
J-2		0.00	340.99	157.00	183.99	79.73
J-3		0.00	340.65	173.00	167.65	72.65
J-4		0.00	336.98	195.00	141.98	61.53
J-5		0.00	306.88	119.00	187.88	81.41
J-6		0.00	305.88	113.00	192.88	83.58
J-8		0.00	306.04	112.00	194.04	84.08
J-9		0.00	307.33	119.00	188.33	81.61
J-10		0.00	306.10	112.00	194.10	84.11
J-11		0.00	306.77	116.00	190.77	82.67
J-12		1.00	306.11	112.00	194.11	84.12
J-13		0.00	306.11	112.00	194.11	84.12
J-14		0.00	305.09	116.00	189.09	81.94
J-16		0.00	306.11	113.00	193.11	83.68
J-17		0.00	306.62	116.00	190.62	82.60
J-18		137.00	336.84	195.00	141.84	61.46
J-19		0.00	306.46	116.00	190.46	82.53
J-20		0.00	306.13	116.00	190.13	82.39
J-21		0.00	305.57	115.00	190.57	82.58
J-22		1500.00	302.66	119.00	183.66	79.59
J-29		0.00	305.85	115.00	190.85	82.70
WRS-1		----	341.00			
WRS-2		----	341.00			
O-BF-1		0.00	309.52	195.00	114.52	49.63
O-BF-2		0.00	309.72	195.00	114.72	49.71

M A X I M U M A N D M I N I M U M V A L U E S

P R E S S U R E S

JUNCTION NUMBER	MAXIMUM PRESSURES psi	JUNCTION NUMBER	MINIMUM PRESSURES psi
J-12	84.12	O-BF-1	49.63
J-13	84.12	O-BF-2	49.71
J-10	84.11	I-BF-1	61.14

V E L O C I T I E S

PIPE NUMBER	MAXIMUM VELOCITY (ft/s)	PIPE NUMBER	MINIMUM VELOCITY (ft/s)
P-33	6.37	P-13	0.18
P-23	4.82	P-29	0.19
P-16	4.82	P-19	0.51

**Nakano (Dennergy Ranch)
City of Chula Vista/City of San Diego PUD
Computer Model**

**June 20, 2022
Dexter Wilson Eng., Inc.
Job 648-038**

S U M M A R Y O F I N F L O W S A N D O U T F L O W S

(+) INFLOWS INTO THE SYSTEM FROM SUPPLY NODES
(-) OUTFLOWS FROM THE SYSTEM INTO SUPPLY NODES

NODE NAME	FLOWRATE gpm	NODE TITLE
WRS-1	1448.69	
WRS-2	189.31	

NET SYSTEM INFLOW = 1638.00
NET SYSTEM OUTFLOW = 0.00
NET SYSTEM DEMAND = 1638.00

=====
Case: 7

C H A N G E S F O R N E X T S I M U L A T I O N (Change Number = 7)

**Nakano Project
1,500 gpm Fire Flow Demand at Node 13**

JUNCTION DEMANDS CHANGED - PLEASE SEE RESULTS TABLE

RESULTS OBTAINED AFTER 5 TRIALS: ACCURACY = 0.13313E-06

P I P E L I N E R E S U L T S

STATUS CODE: XX -CLOSED PIPE CV -CHECK VALVE

P I P E N A M E	NODE #1	NUMBERS #2	FLOWRATE gpm	HEAD LOSS ft	MINOR LOSS ft	LINE VELO. ft/s	HL+ML/ 1000 ft/f	HL/ 1000 ft/f
P-1	WRS-2	J-2	189.31	0.01	0.00	0.54	0.13	0.13
P-2	J-3	WRS-1	-1448.69	0.35	0.00	4.11	5.84	5.84
P-3	J-3	J-4	1638.00	3.67	0.00	4.65	7.34	7.34
P-4	J-4	J-18	883.64	0.14	0.00	2.51	2.34	2.34
P-5	J-4	I-BF-2	754.36	0.75	0.00	4.81	12.57	12.57
P-6	O-BF-2	J-9	754.36	1.93	0.50	4.81	15.85	12.57
P-7	J-5	J-17	729.62	1.06	0.34	4.66	15.56	11.82
P-9	J-8	J-6	-333.66	1.25	0.05	2.13	2.89	2.77
P-10	J-9	J-5	398.06	0.15	0.10	2.54	6.42	3.85
P-11	J-9	J-11	356.30	1.44	0.14	2.27	3.44	3.13
P-12	J-10	J-8	-333.66	0.39	0.10	2.13	3.48	2.77
P-13	J-10	J-12	780.60	6.16	0.39	4.98	14.23	13.39
P-14	J-12	J-13	1500.00	14.58	7.87	17.02	280.62	182.24
P-16	O-BF-1	J-5	746.64	2.10	0.49	4.77	15.24	12.33
P-17	J-21	J-29	629.97	1.62	0.00	4.02	9.00	9.00
P-18	J-22	J-14	415.08	1.70	0.00	2.65	4.16	4.16
P-19	J-10	J-16	-446.93	0.33	0.00	2.85	4.77	4.77
P-20	J-21	J-19	-214.88	0.61	0.03	1.37	1.29	1.23
P-21	J-1	J-3	189.31	0.13	0.00	0.54	0.13	0.13
P-22	J-2	J-1	189.31	0.20	0.00	0.54	0.13	0.13
P-23	J-18	I-BF-1	746.64	0.74	0.00	4.77	12.33	12.33
P-24	J-19	J-17	-729.62	0.83	0.00	4.66	11.82	11.82
P-25	J-19	J-11	-356.30	0.78	0.11	2.27	3.58	3.13
P-26	J-29	J-6	333.66	0.22	0.00	2.13	2.77	2.77
P-27	J-20	J-29	-296.30	1.11	0.06	1.89	2.34	2.23
P-28	J-20	J-19	-871.03	2.95	0.48	5.56	19.07	16.41

**Nakano (Dennergy Ranch)
City of Chula Vista/City of San Diego PUD
Computer Model**

**June 20, 2022
Dexter Wilson Eng., Inc.
Job 648-038**

P-29	J-20	J-12	720.40	7.39	0.00	4.60	11.54	11.54
P-30	J-14	J-21	415.08	0.29	0.04	2.65	4.78	4.16
P-31	J-16	J-20	-446.93	0.38	0.13	2.85	6.35	4.77
P-33	J-5	J-22	415.08	0.83	0.00	2.65	4.16	4.16

P U M P / L O S S E L E M E N T R E S U L T S

NAME	FLOWRATE gpm	INLET HEAD ft	OUTLET HEAD ft	PUMP HEAD ft	EFFIC- ENCY %	USEFUL POWER Hp	INCREMTL COST \$	TOTAL COST \$	#PUMPS PARALLEL	#PUMPS SERIES	NPSH Avail. ft	Case
BF-1	746.64	141.10	114.57	-26.5	75.00	-5.	-0.3	-1.3	**	**	173.9	7.0000
BF-2	754.36	141.23	114.67	-26.6	75.00	-5.	-0.2	-1.8	**	**	174.1	7.0000

N O D E R E S U L T S

NODE NAME	NODE TITLE	EXTERNAL DEMAND gpm	HYDRAULIC GRADE ft	NODE ELEVATION ft	PRESSURE HEAD ft	NODE PRESSURE psi
I-BF-1		0.00	336.10	195.00	141.10	61.14
I-BF-2		0.00	336.23	195.00	141.23	61.20
J-1		0.00	340.78	165.00	175.78	76.17
J-2		0.00	340.99	157.00	183.99	79.73
J-3		0.00	340.65	173.00	167.65	72.65
J-4		0.00	336.98	195.00	141.98	61.53
J-5		0.00	306.98	119.00	187.98	81.46
J-6		0.00	302.27	113.00	189.27	82.02
J-8		0.00	300.97	112.00	188.97	81.89
J-9		0.00	307.23	119.00	188.23	81.57
J-10		0.00	300.48	112.00	188.48	81.67
J-11		0.00	305.65	116.00	189.65	82.18
J-12		1.00	293.93	112.00	181.93	78.84
J-13		1500.00	271.48	112.00	159.48	69.11
J-14		0.00	304.45	116.00	188.45	81.66
J-16		0.00	300.81	113.00	187.81	81.39
J-17		0.00	305.58	116.00	189.58	82.15
J-18		137.00	336.84	195.00	141.84	61.46
J-19		0.00	304.75	116.00	188.75	81.79
J-20		0.00	301.32	116.00	185.32	80.31
J-21		0.00	304.11	115.00	189.11	81.95
J-22		0.00	306.15	119.00	187.15	81.10
J-29		0.00	302.49	115.00	187.49	81.25
WRS-1		----	341.00			
WRS-2		----	341.00			
O-BF-1		0.00	309.57	195.00	114.57	49.65
O-BF-2		0.00	309.67	195.00	114.67	49.69

M A X I M U M A N D M I N I M U M V A L U E S

P R E S S U R E S

JUNCTION NUMBER	MAXIMUM PRESSURES psi	JUNCTION NUMBER	MINIMUM PRESSURES psi
J-11	82.18	O-BF-1	49.65
J-17	82.15	O-BF-2	49.69
J-6	82.02	I-BF-1	61.14

**Nakano (Dennergy Ranch)
City of Chula Vista/City of San Diego PUD
Computer Model**

**June 20, 2022
Dexter Wilson Eng., Inc.
Job 648-038**

V E L O C I T I E S

PIPE NUMBER	MAXIMUM VELOCITY (ft/s)	PIPE NUMBER	MINIMUM VELOCITY (ft/s)
P-14	17.02	P-1	0.54
P-28	5.56	P-21	0.54
P-13	4.98	P-22	0.54

S U M M A R Y O F I N F L O W S A N D O U T F L O W S

(+) INFLOWS INTO THE SYSTEM FROM SUPPLY NODES
(-) OUTFLOWS FROM THE SYSTEM INTO SUPPLY NODES

NODE NAME	FLOWRATE gpm	NODE TITLE
WRS-1	1448.69	
WRS-2	189.31	

NET SYSTEM INFLOW = 1638.00
NET SYSTEM OUTFLOW = 0.00
NET SYSTEM DEMAND = 1638.00

=====
Case: 8

C H A N G E S F O R N E X T S I M U L A T I O N (Change Number = 8)

**Nakano Project
3,000 gpm Fire Flow split between Node 11 and Node 16**

JUNCTION DEMANDS CHANGED - PLEASE SEE RESULTS TABLE

RESULTS OBTAINED AFTER 5 TRIALS: ACCURACY = 0.20341E-04

P I P E L I N E R E S U L T S

STATUS CODE: XX -CLOSED PIPE CV -CHECK VALVE

P I P E N A M E	N O D E N U M B E R S		F L O W R A T E gpm	H E A D L O S S ft	M I N O R L O S S ft	L I N E V E L O . ft/s	H L + M L / 1 0 0 0 ft/f	H L / 1 0 0 0 ft/f
	#1	#2						
P-1	WRS-2	J-2	362.66	0.04	0.00	1.03	0.45	0.45
P-2	J-3	WRS-1	-2775.34	1.17	0.00	7.87	19.48	19.48
P-3	J-3	J-4	3138.00	12.23	0.00	8.90	24.45	24.45
P-4	J-4	J-18	1609.33	0.43	0.00	4.57	7.10	7.10
P-5	J-4	I-BF-2	1528.67	2.79	0.00	9.76	46.50	46.50
P-6	O-BF-2	J-9	1528.67	7.15	2.07	9.76	59.96	46.50
P-7	J-5	J-17	1369.46	3.41	1.19	8.74	51.11	37.93
P-9	J-8	J-6	-380.36	1.59	0.07	2.43	3.69	3.54
P-10	J-9	J-5	581.42	0.30	0.21	3.71	13.24	7.76
P-11	J-9	J-11	947.25	8.82	0.99	6.05	21.32	19.16
P-12	J-10	J-8	-380.36	0.50	0.13	2.43	4.45	3.54
P-13	J-10	J-12	-213.26	0.56	0.03	1.36	1.27	1.21

**Nakano (Dennergy Ranch)
City of Chula Vista/City of San Diego PUD
Computer Model**

**June 20, 2022
Dexter Wilson Eng., Inc.
Job 648-038**

P-14	J-12	J-13	0.00	0.00	0.00	0.00	0.00	0.00
P-16	O-BF-1	J-5	1472.33	7.37	1.92	9.40	54.67	43.37
P-17	J-21	J-29	680.65	1.87	0.00	4.34	10.39	10.39
P-18	J-22	J-14	684.29	4.30	0.00	4.37	10.49	10.49
P-19	J-10	J-16	593.62	0.56	0.00	3.79	8.07	8.07
P-20	J-21	J-19	3.64	0.00	0.00	0.02	0.00	0.00
P-21	J-1	J-3	362.66	0.45	0.00	1.03	0.45	0.45
P-22	J-2	J-1	362.66	0.67	0.00	1.03	0.45	0.45
P-23	J-18	I-BF-1	1472.33	2.60	0.00	9.40	43.37	43.37
P-24	J-19	J-17	-1369.46	2.65	0.00	8.74	37.93	37.93
P-25	J-19	J-11	552.75	1.77	0.27	3.53	8.15	7.07
P-26	J-29	J-6	380.36	0.28	0.00	2.43	3.54	3.54
P-27	J-20	J-29	-300.29	1.14	0.06	1.92	2.40	2.28
P-28	J-20	J-19	-820.35	2.64	0.43	5.24	17.05	14.68
P-29	J-20	J-12	214.26	0.78	0.00	1.37	1.22	1.22
P-30	J-14	J-21	684.29	0.73	0.12	4.37	12.19	10.49
P-31	J-16	J-20	-906.38	1.41	0.52	5.78	24.16	17.66
P-33	J-5	J-22	684.29	2.10	0.00	4.37	10.49	10.49

P U M P / L O S S E L E M E N T R E S U L T S

NAME	FLOWRATE gpm	INLET HEAD ft	OUTLET HEAD ft	PUMP HEAD ft	EFFIC- ENCY %	USEFUL POWER Hp	INCREMTL COST \$	TOTAL COST \$	#PUMPS PARALLEL	#PUMPS SERIES	NPSH Avail. ft	Case
BF-1	1472.33	129.58	100.66	-28.9	75.00	-11.	-0.2	-1.6	**	**	161.4	8.0000
BF-2	1528.67	129.82	101.10	-28.7	75.00	-11.	-0.3	-2.1	**	**	161.5	8.0000

N O D E R E S U L T S

NODE NAME	NODE TITLE	EXTERNAL DEMAND gpm	HYDRAULIC GRADE ft	NODE ELEVATION ft	PRESSURE HEAD ft	NODE PRESSURE psi
I-BF-1		0.00	324.58	195.00	129.58	56.15
I-BF-2		0.00	324.82	195.00	129.82	56.25
J-1		0.00	340.28	165.00	175.28	75.96
J-2		0.00	340.96	157.00	183.96	79.71
J-3		0.00	339.83	173.00	166.83	72.29
J-4		0.00	327.61	195.00	132.61	57.46
J-5		0.00	286.37	119.00	167.37	72.53
J-6		0.00	276.96	113.00	163.96	71.05
J-8		0.00	275.30	112.00	163.30	70.76
J-9		0.00	286.89	119.00	167.89	72.75
J-10		0.00	274.68	112.00	162.68	70.49
J-11		1500.00	277.08	116.00	161.08	69.80
J-12		1.00	275.26	112.00	163.26	70.75
J-13		0.00	275.26	112.00	163.26	70.75
J-14		0.00	279.97	116.00	163.97	71.05
J-16		1500.00	274.11	113.00	161.11	69.82
J-17		0.00	281.77	116.00	165.77	71.83
J-18		137.00	327.18	195.00	132.18	57.28
J-19		0.00	279.11	116.00	163.11	70.68
J-20		0.00	276.05	116.00	160.05	69.35
J-21		0.00	279.11	115.00	164.11	71.12
J-22		0.00	284.27	119.00	165.27	71.62
J-29		0.00	277.24	115.00	162.24	70.31
WRS-1		----	341.00			
WRS-2		----	341.00			
O-BF-1		0.00	295.66	195.00	100.66	43.62
O-BF-2		0.00	296.10	195.00	101.10	43.81

**Nakano (Dennergy Ranch)
City of Chula Vista/City of San Diego PUD
Computer Model**

**June 20, 2022
Dexter Wilson Eng., Inc.
Job 648-038**

M A X I M U M A N D M I N I M U M V A L U E S

P R E S S U R E S

JUNCTION NUMBER	MAXIMUM PRESSURES psi	JUNCTION NUMBER	MINIMUM PRESSURES psi
J-2	79.71	O-BF-1	43.62
J-1	75.96	O-BF-2	43.81
J-9	72.75	I-BF-1	56.15

V E L O C I T I E S

PIPE NUMBER	MAXIMUM VELOCITY (ft/s)	PIPE NUMBER	MINIMUM VELOCITY (ft/s)
P-5	9.76	P-20	0.02
P-6	9.76	P-1	1.03
P-16	9.40	P-21	1.03

S U M M A R Y O F I N F L O W S A N D O U T F L O W S

(+) INFLOWS INTO THE SYSTEM FROM SUPPLY NODES
(-) OUTFLOWS FROM THE SYSTEM INTO SUPPLY NODES

NODE NAME	FLOWRATE gpm	NODE TITLE
WRS-1	2775.34	
WRS-2	362.66	

NET SYSTEM INFLOW = 3138.00
NET SYSTEM OUTFLOW = 0.00
NET SYSTEM DEMAND = 3138.00

=====
Case: 9

C H A N G E S F O R N E X T S I M U L A T I O N (Change Number = 9)

**Nakano Project
3,000 gpm Fire Flow split between Node 6 and Node 14**

JUNCTION DEMANDS CHANGED - PLEASE SEE RESULTS TABLE

RESULTS OBTAINED AFTER 5 TRIALS: ACCURACY = 0.35855E-05

P I P E L I N E R E S U L T S

STATUS CODE: XX -CLOSED PIPE CV -CHECK VALVE

P I P E N A M E	NODE #1	NUMBERS #2	FLOWRATE gpm	HEAD LOSS ft	MINOR LOSS ft	LINE VELO. ft/s	HL+ML/ 1000 ft/f	HL/ 1000 ft/f
P-1	WRS-2	J-2	362.66	0.04	0.00	1.03	0.45	0.45
P-2	J-3	WRS-1	-2775.34	1.17	0.00	7.87	19.48	19.48

**Nakano (Dennergy Ranch)
City of Chula Vista/City of San Diego PUD
Computer Model**

**June 20, 2022
Dexter Wilson Eng., Inc.
Job 648-038**

P-3	J-3	J-4	3138.00	12.23	0.00	8.90	24.45	24.45
P-4	J-4	J-18	1625.26	0.43	0.00	4.61	7.23	7.23
P-5	J-4	I-BF-2	1512.74	2.74	0.00	9.65	45.60	45.60
P-6	O-BF-2	J-9	1512.74	7.01	2.03	9.65	58.79	45.60
P-7	J-5	J-17	1280.14	3.01	1.04	8.17	44.99	33.47
P-9	J-8	J-6	545.17	3.10	0.14	3.48	7.20	6.89
P-10	J-9	J-5	867.85	0.64	0.48	5.54	28.51	16.30
P-11	J-9	J-11	644.89	4.33	0.46	4.12	10.40	9.40
P-12	J-10	J-8	545.17	0.96	0.26	3.48	8.77	6.89
P-13	J-10	J-12	-146.17	0.28	0.01	0.93	0.63	0.60
P-14	J-12	J-13	0.00	0.00	0.00	0.00	0.00	0.00
P-16	O-BF-1	J-5	1488.26	7.52	1.96	9.50	55.79	44.25
P-17	J-21	J-29	412.84	0.74	0.00	2.63	4.12	4.12
P-18	J-22	J-14	1075.97	9.95	0.00	6.87	24.26	24.26
P-19	J-10	J-16	-399.00	0.27	0.00	2.55	3.86	3.86
P-20	J-21	J-19	-836.88	7.62	0.44	5.34	16.12	15.23
P-21	J-1	J-3	362.66	0.45	0.00	1.03	0.45	0.45
P-22	J-2	J-1	362.66	0.67	0.00	1.03	0.45	0.45
P-23	J-18	I-BF-1	1488.26	2.65	0.00	9.50	44.25	44.25
P-24	J-19	J-17	-1280.14	2.34	0.00	8.17	33.47	33.47
P-25	J-19	J-11	-644.89	2.35	0.37	4.12	10.88	9.40
P-26	J-29	J-6	954.83	1.56	0.00	6.09	19.45	19.45
P-27	J-20	J-29	541.98	3.41	0.19	3.46	7.19	6.81
P-28	J-20	J-19	-1088.16	4.46	0.75	6.95	28.94	24.78
P-29	J-20	J-12	147.17	0.39	0.00	0.94	0.61	0.61
P-30	J-14	J-21	-424.03	0.30	0.05	2.71	4.98	4.33
P-31	J-16	J-20	-399.00	0.31	0.10	2.55	5.12	3.86
P-33	J-5	J-22	1075.97	4.85	0.00	6.87	24.26	24.26

P U M P / L O S S E L E M E N T R E S U L T S

NAME	FLOWRATE gpm	INLET HEAD ft	OUTLET HEAD ft	PUMP HEAD ft	EFFIC- ENCY %	USEFUL POWER Hp	INCREMENTL COST \$	TOTAL COST \$	#PUMPS PARALLEL	#PUMPS SERIES	NPSH Avail. ft	Case
BF-1	1488.26	129.52	100.54	-29.0	75.00	-11.	-0.5	-2.1	**	**	161.3	9.0000
BF-2	1512.74	129.87	101.21	-28.7	75.00	-11.	-0.6	-2.6	**	**	161.6	9.0000

N O D E R E S U L T S

NODE NAME	NODE TITLE	EXTERNAL DEMAND gpm	HYDRAULIC GRADE ft	NODE ELEVATION ft	PRESSURE HEAD ft	NODE PRESSURE psi
I-BF-1		0.00	324.52	195.00	129.52	56.12
I-BF-2		0.00	324.87	195.00	129.87	56.28
J-1		0.00	340.28	165.00	175.28	75.96
J-2		0.00	340.96	157.00	183.96	79.71
J-3		0.00	339.83	173.00	166.83	72.29
J-4		0.00	327.61	195.00	132.61	57.46
J-5		0.00	286.07	119.00	167.07	72.40
J-6		1500.00	269.32	113.00	156.32	67.74
J-8		0.00	272.56	112.00	160.56	69.57
J-9		0.00	287.18	119.00	168.18	72.88
J-10		0.00	273.78	112.00	161.78	70.11
J-11		0.00	282.39	116.00	166.39	72.10
J-12		1.00	274.07	112.00	162.07	70.23
J-13		0.00	274.07	112.00	162.07	70.23
J-14		1500.00	271.26	116.00	155.26	67.28
J-16		0.00	274.05	113.00	161.05	69.79
J-17		0.00	282.02	116.00	166.02	71.94
J-18		137.00	327.17	195.00	132.17	57.27
J-19		0.00	279.67	116.00	163.67	70.92

**Nakano (Dennergy Ranch)
City of Chula Vista/City of San Diego PUD
Computer Model**

**June 20, 2022
Dexter Wilson Eng., Inc.
Job 648-038**

J-20	0.00	274.46	116.00	158.46	68.67
J-21	0.00	271.61	115.00	156.61	67.87
J-22	0.00	281.21	119.00	162.21	70.29
J-29	0.00	270.87	115.00	155.87	67.54
WRS-1	----	341.00			
WRS-2	----	341.00			
O-BF-1	0.00	295.54	195.00	100.54	43.57
O-BF-2	0.00	296.21	195.00	101.21	43.86

M A X I M U M A N D M I N I M U M V A L U E S

P R E S S U R E S

JUNCTION NUMBER	MAXIMUM PRESSURES psi	JUNCTION NUMBER	MINIMUM PRESSURES psi
J-2	79.71	O-BF-1	43.57
J-1	75.96	O-BF-2	43.86
J-9	72.88	I-BF-1	56.12

V E L O C I T I E S

PIPE NUMBER	MAXIMUM VELOCITY (ft/s)	PIPE NUMBER	MINIMUM VELOCITY (ft/s)
P-5	9.65	P-13	0.93
P-6	9.65	P-29	0.94
P-23	9.50	P-1	1.03

S U M M A R Y O F I N F L O W S A N D O U T F L O W S

(+) INFLOWS INTO THE SYSTEM FROM SUPPLY NODES
(-) OUTFLOWS FROM THE SYSTEM INTO SUPPLY NODES

NODE NAME	FLOWRATE gpm	NODE TITLE
WRS-1	2775.34	
WRS-2	362.66	

NET SYSTEM INFLOW = 3138.00
NET SYSTEM OUTFLOW = 0.00
NET SYSTEM DEMAND = 3138.00

=====
Case: 10

C H A N G E S F O R N E X T S I M U L A T I O N (Change Number = 10)

**Nakano Project
3,000 gpm Fire Flow split between Node 6 and Node 14
WRS 1 Out of Service**

JUNCTION DEMANDS CHANGED - PLEASE SEE RESULTS TABLE

Pipe P-2 is CLOSED

RESULTS OBTAINED AFTER 4 TRIALS: ACCURACY = 0.30421E-05

**Nakano (Dennergy Ranch)
City of Chula Vista/City of San Diego PUD
Computer Model**

**June 20, 2022
Dexter Wilson Eng., Inc.
Job 648-038**

PIPELINE RESULTS

STATUS CODE: XX -CLOSED PIPE CV -CHECK VALVE

PIPE NAME	NODE NUMBERS		FLOWRATE gpm	HEAD LOSS ft	MINOR LOSS ft	LINE VELO. ft/s	HL+ML/ 1000 ft/f	HL/ 1000 ft/f
	#1	#2						
P-1	WRS-2	J-2	3138.00	2.45	0.00	8.90	24.45	24.45
P-2-XX	J-3	WRS-1						
P-3	J-3	J-4	3138.00	12.23	0.00	8.90	24.45	24.45
P-4	J-4	J-18	1625.26	0.43	0.00	4.61	7.23	7.23
P-5	J-4	I-BF-2	1512.74	2.74	0.00	9.65	45.60	45.60
P-6	O-BF-2	J-9	1512.74	7.01	2.03	9.65	58.79	45.60
P-7	J-5	J-17	1280.14	3.01	1.04	8.17	44.99	33.47
P-9	J-8	J-6	545.17	3.10	0.14	3.48	7.20	6.89
P-10	J-9	J-5	867.85	0.64	0.48	5.54	28.51	16.30
P-11	J-9	J-11	644.89	4.33	0.46	4.12	10.40	9.40
P-12	J-10	J-8	545.17	0.96	0.26	3.48	8.77	6.89
P-13	J-10	J-12	-146.17	0.28	0.01	0.93	0.63	0.60
P-14	J-12	J-13	0.00	0.00	0.00	0.00	0.00	0.00
P-16	O-BF-1	J-5	1488.26	7.52	1.96	9.50	55.79	44.25
P-17	J-21	J-29	412.84	0.74	0.00	2.63	4.12	4.12
P-18	J-22	J-14	1075.97	9.95	0.00	6.87	24.26	24.26
P-19	J-10	J-16	-399.00	0.27	0.00	2.55	3.86	3.86
P-20	J-21	J-19	-836.88	7.62	0.44	5.34	16.12	15.23
P-21	J-1	J-3	3138.00	24.45	0.00	8.90	24.45	24.45
P-22	J-2	J-1	3138.00	36.68	0.00	8.90	24.45	24.45
P-23	J-18	I-BF-1	1488.26	2.65	0.00	9.50	44.25	44.25
P-24	J-19	J-17	-1280.14	2.34	0.00	8.17	33.47	33.47
P-25	J-19	J-11	-644.89	2.35	0.37	4.12	10.88	9.40
P-26	J-29	J-6	954.83	1.56	0.00	6.09	19.45	19.45
P-27	J-20	J-29	541.98	3.41	0.19	3.46	7.19	6.81
P-28	J-20	J-19	-1088.16	4.46	0.75	6.95	28.94	24.78
P-29	J-20	J-12	147.17	0.39	0.00	0.94	0.61	0.61
P-30	J-14	J-21	-424.03	0.30	0.05	2.71	4.98	4.33
P-31	J-16	J-20	-399.00	0.31	0.10	2.55	5.12	3.86
P-33	J-5	J-22	1075.97	4.85	0.00	6.87	24.26	24.26

PUMP/LOSS ELEMENT RESULTS

NAME	FLOWRATE gpm	INLET HEAD ft	OUTLET HEAD ft	PUMP HEAD ft	EFFIC- ENCY %	USEFUL POWER Hp	INCREMENTL COST \$	TOTAL COST \$	#PUMPS PARALLEL	#PUMPS SERIES	NPSH Avail. ft	Case
BF-1	1488.26	67.11	38.14	-29.0	75.00	-11.	-0.5	-2.6	**	**	98.9	10.0000
BF-2	1512.74	67.46	38.81	-28.7	75.00	-11.	-0.5	-3.2	**	**	99.2	10.0000

NODE RESULTS

NODE NAME	NODE TITLE	EXTERNAL DEMAND gpm	HYDRAULIC GRADE ft	NODE ELEVATION ft	PRESSURE HEAD ft	NODE PRESSURE psi
I-BF-1		0.00	262.11	195.00	67.11	29.08
I-BF-2		0.00	262.46	195.00	67.46	29.23
J-1		0.00	301.88	165.00	136.88	59.31
J-2		0.00	338.55	157.00	181.55	78.67
J-3		0.00	277.43	173.00	104.43	45.25
J-4		0.00	265.20	195.00	70.20	30.42

**Nakano (Dennergy Ranch)
City of Chula Vista/City of San Diego PUD
Computer Model**

**June 20, 2022
Dexter Wilson Eng., Inc.
Job 648-038**

J-5	0.00	223.66	119.00	104.66	45.35
J-6	1500.00	206.91	113.00	93.91	40.69
J-8	0.00	210.15	112.00	98.15	42.53
J-9	0.00	224.77	119.00	105.77	45.83
J-10	0.00	211.38	112.00	99.38	43.06
J-11	0.00	219.99	116.00	103.99	45.06
J-12	1.00	211.67	112.00	99.67	43.19
J-13	0.00	211.67	112.00	99.67	43.19
J-14	1500.00	208.86	116.00	92.86	40.24
J-16	0.00	211.65	113.00	98.65	42.75
J-17	0.00	219.61	116.00	103.61	44.90
J-18	137.00	264.77	195.00	69.77	30.23
J-19	0.00	217.27	116.00	101.27	43.88
J-20	0.00	212.06	116.00	96.06	41.63
J-21	0.00	209.21	115.00	94.21	40.82
J-22	0.00	218.81	119.00	99.81	43.25
J-29	0.00	208.47	115.00	93.47	40.50
WRS-1	----	341.00			
WRS-2	----	341.00			
O-BF-1	0.00	233.14	195.00	38.14	16.53
O-BF-2	0.00	233.81	195.00	38.81	16.82

M A X I M U M A N D M I N I M U M V A L U E S

P R E S S U R E S

JUNCTION NUMBER	MAXIMUM PRESSURES psi	JUNCTION NUMBER	MINIMUM PRESSURES psi
J-2	78.67	O-BF-1	16.53
J-1	59.31	O-BF-2	16.82
J-9	45.83	I-BF-1	29.08

V E L O C I T I E S

PIPE NUMBER	MAXIMUM VELOCITY (ft/s)	PIPE NUMBER	MINIMUM VELOCITY (ft/s)
P-5	9.65	P-13	0.93
P-6	9.65	P-29	0.94
P-16	9.50	P-19	2.55

S U M M A R Y O F I N F L O W S A N D O U T F L O W S

(+) INFLOWS INTO THE SYSTEM FROM SUPPLY NODES
(-) OUTFLOWS FROM THE SYSTEM INTO SUPPLY NODES

NODE NAME	FLOWRATE gpm	NODE TITLE
WRS-1	0.00	
WRS-2	3138.00	

NET SYSTEM INFLOW = 3138.00
NET SYSTEM OUTFLOW = 0.00
NET SYSTEM DEMAND = 3138.00

***** HYDRAULIC ANALYSIS COMPLETED *****

\\ARTIC\DWG\648038\REPORT\WP_WTR_EXHIBIT-A_IP.DWG 6/16/2022 10:46:04 AM LAYOUT:24x36 USER:SLD

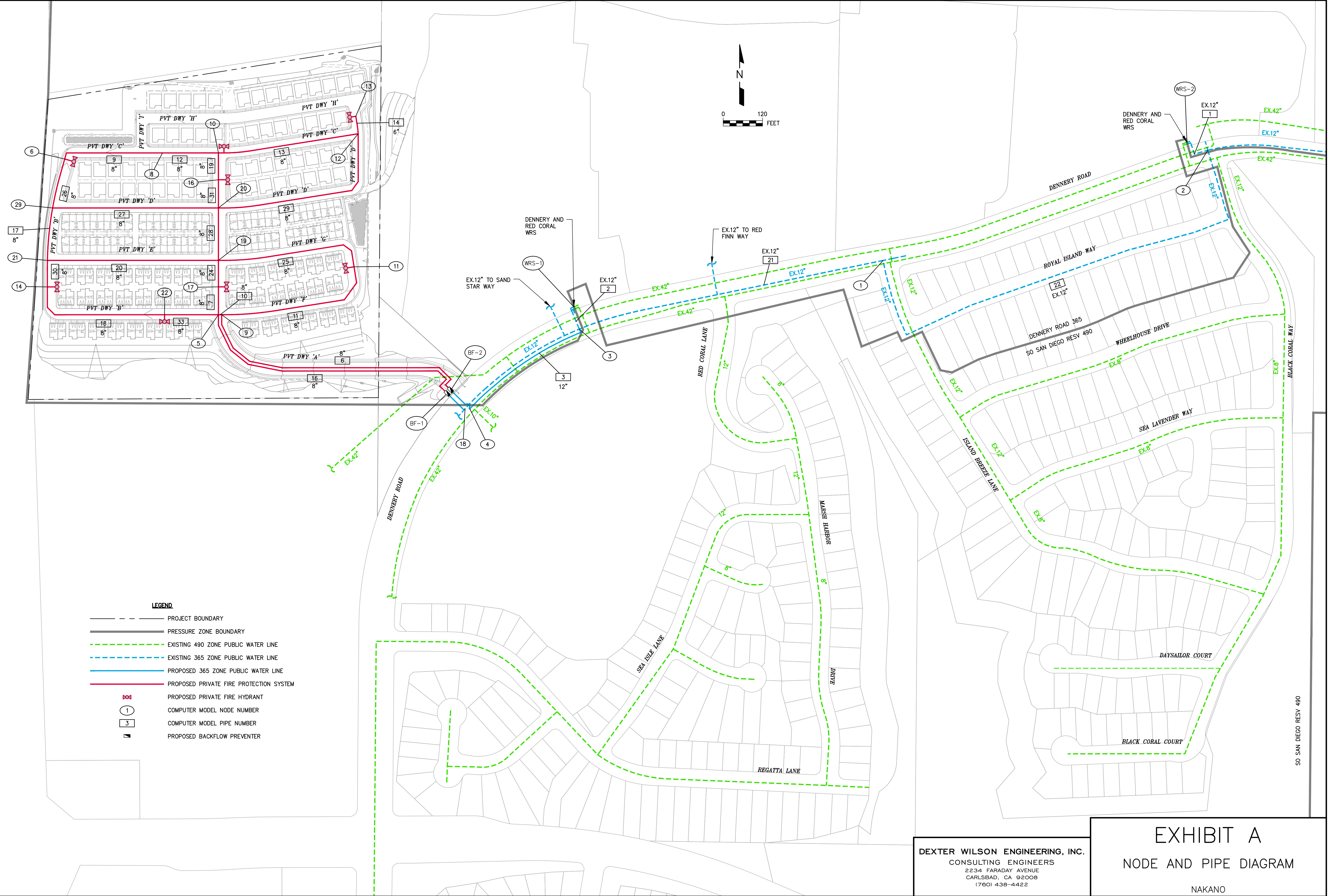

LEGEND

- PROJECT BOUNDARY
- PRESSURE ZONE BOUNDARY
- EXISTING 490 ZONE PUBLIC WATER LINE
- EXISTING 365 ZONE PUBLIC WATER LINE
- PROPOSED 365 ZONE PUBLIC WATER LINE
- PROPOSED PRIVATE FIRE PROTECTION SYSTEM
- PROPOSED PRIVATE FIRE HYDRANT
- COMPUTER MODEL NODE NUMBER
- COMPUTER MODEL PIPE NUMBER
- PROPOSED BACKFLOW PREVENTER

DEXTER WILSON ENGINEERING, INC.
 CONSULTING ENGINEERS
 2234 FARADAY AVENUE
 CARLSBAD, CA 92008
 (760) 438-4422

EXHIBIT A
NODE AND PIPE DIAGRAM
 NAKANO