



# PDP SWQMP

## PRIORITY DEVELOPMENT PROJECT (PDP) STORM WATER QUALITY MANAGEMENT PLAN (SWQMP)

Project Name \_\_\_\_\_

Assessor's Parcel Number(s) \_\_\_\_\_ City of San Diego

Permit Application Number \_\_\_\_\_ PTS#647766

Drawing Numbers \_\_\_\_\_

CIVIL ENGINEER NAME: \_\_\_\_\_; PE # \_\_\_\_\_



\_\_\_\_\_  
Wet Signature and Stamp

**PREPARED FOR:** Applicant Name: \_\_\_\_\_

Address: \_\_\_\_\_

Telephone # \_\_\_\_\_

**PREPARED BY:** Company Name: \_\_\_\_\_

Address: \_\_\_\_\_

Telephone # \_\_\_\_\_

**DATE:**

Approved By: City of Chula Vista  
(print Name & Sign)

Date: \_\_\_\_\_

P:\4409\Engr\Reports-4409.02-Nakano\Entitlement\SWQMP  
Job# 4409.02

PDP SWQMP Template Date: March 2019

*Page intentionally left blank for double-sided printing*

Project Name/\_\_\_\_\_

## TABLE OF CONTENTS

The checklist on this page summarized the table and attachments to be included with this PDP SWQMP Submittal. Tables & attachments with boxes already checked (✓) are required for all Projects

- Acronym Sheet**
- Certification Page**
- Submittal Record**
- Project Vicinity Map**
- Attach a copy of the Intake Form: Storm Water Requirements Applicability Checklist**
- HMP Exemption Exhibit (if Applicable)**
- FORM I-3B Site Information Checklist for PDPs**
- FORM I-4: Source Control BMP Checklist for All Development Projects**
- FORM I-5: Site Design BMP Checklist for All Development Projects**
- FORM I-6: Summary of PDP Structural BMPs**
- ATTACHEMNT 1: Backup for PDP Pollutant Control BMPs**
  - Attachment 1A: DMA Exhibit
  - Attachment 1B: Tabular Summary of DMAs and Design Capture Volume Calculations
  - Attachment 1C: FORM I-7 Harvest and Use Feasibility Screening (when applicable)
  - Attachment 1D: Infiltration Information Attachment 1E: Pollutant Control BMP Design Worksheets / Calculations for each DMA and Structural BMP Worksheets from Appendix B, as applicable
- ATTACHMENT 2: Backup for PDP Hydromodification Control Measures**
  - Attachment 2A: Hydromodification Management Exhibit
  - Attachment 2B: Management of Critical Coarse Sediment Yield Areas
  - Attachment 2C: Geomorphic Assessment of Receiving Channels
  - Attachment 2D: Flow Control Facility Design; Overflow Design Summary for each structural BMP
- ATTACHMENT 3: Structural BMP Maintenance Plan**
- ATTACHMENT 4: Copy of Plan Sheets Showing Permanent Storm Water BMPs**
- ATTACHMENT 5: Project's Drainage Report**
- ATTACHMENT 6: Project's Geotechnical and Groundwater Investigation Report**

Project Name/\_\_\_\_\_

## ACRONYMS

APN	Assessor's Parcel Number
BMP	Best Management Practice
HMP	Hydromodification Management Plan
HSG	Hydrologic Soil Group
MS4	Municipal Separate Storm Sewer System
N/A	Not Applicable
NRCS	Natural Resources Conservation Service
PDP	Priority Development Project
PE	Professional Engineer
SC	Source Control
SD	Site Design
SDRWQCB	San Diego Regional Water Quality Control Board
SIC	Standard Industrial Classification
SWQMP	Storm Water Quality Management Plan

Project Name/ \_\_\_\_\_

## Certification Page

Project Name: Nakano

Permit Application Number: \_\_\_\_\_

I hereby declare that I am the Engineer in Responsible Charge of design of storm water best management practices (BMPs) for this project, and that I have exercised responsible charge over the design of the BMPs as defined in Section 6703 of the Business and Professions Code, and that the design is consistent with the PDP requirements of the City of Chula Vista BMP Design Manual, which is based on the requirements of the San Diego Regional Water Quality Control Board Order No. R9-2013-0001 as amended by R9-2015-0001 and R9-2015-0100 (MS4 Permit).

I have read and understand that the City Engineer has adopted minimum requirements for managing urban runoff, including storm water, from land development activities, as described in the BMP Design Manual. I certify that this PDP SWQMP has been completed to the best of my ability and accurately reflects the project being proposed and the applicable BMPs proposed to minimize the potentially negative impacts of this project's land development activities on water quality. I understand and acknowledge that the plan check review of this PDP SWQMP by the City Engineer is confined to a review and does not relieve me, as the Engineer in Responsible Charge of design of storm water BMPs for this project, of my responsibilities for project design.

1/9/2023

\_\_\_\_\_  
Engineer of Work's Signature

\_\_\_\_\_  
Date

71026

6/30/23

\_\_\_\_\_  
PE #

\_\_\_\_\_  
Expiration Date

Chelisa Pack

\_\_\_\_\_  
Print Name

Project Design Consultants

\_\_\_\_\_  
Company



Project Name/ \_\_\_\_\_

## SUBMITTAL RECORD

Use this Table to keep a record of submittals of this PDP SWQMP. Each time the PDP SWQMP is re-submitted, provide the date and status of the project. In column 4 summarize the changes that have been made or indicate if response to plancheck comments is included. When applicable, insert response to plancheck comments behind this page.

Submittal Number	Date	Project Status	Summary of Changes
1		<input type="checkbox"/> Preliminary Design / Planning/ CEQA <input type="checkbox"/> Final Design	Initial Submittal
2		<input type="checkbox"/> Preliminary Design / Planning/ CEQA <input type="checkbox"/> Final Design	2nd Submittal- Revised Site Plan to add secondary access & avoid Caltrans drainage easement
3		<input type="checkbox"/> Preliminary Design / Planning/ CEQA <input type="checkbox"/> Final Design	
4		<input type="checkbox"/> Preliminary Design / Planning/ CEQA <input type="checkbox"/> Final Design	
5	1/9/23	Preliminary Design	5th Submittal - Updated to include additional City of SD-formatted version of infiltration feasibility letter in Att 1D

### Project Vicinity Map

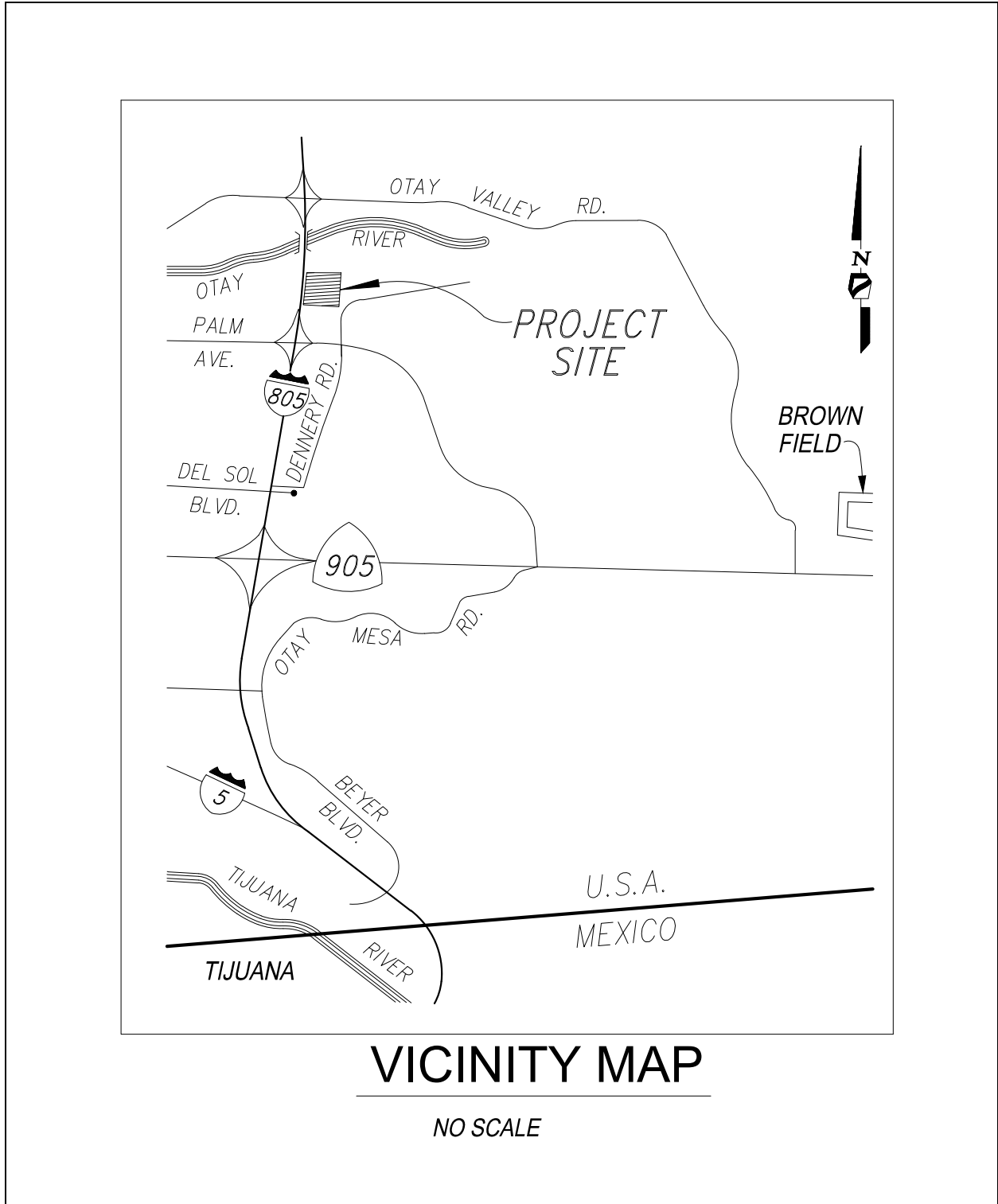



# Storm Water Requirements Applicability Checklist for All Permit Applications

## Intake Form

March 2019 Update

### Project Information

Project Address: North of the intersection of Dennery Rd & Regatta Lane, Chula Vista, CA 92154	Project Application #
Project Name: Nakano	APN(s) 624-071-01
Brief Description of Work Proposed: Construction of 157 residential units, two biofiltration basins and a park lookout to Otay River.	

### The project is (select one):

- New Development Total Impervious Area 566445 ft<sup>2</sup>
- Redevelopment Total new and/or replaced Impervious Area \_\_\_\_\_ ft<sup>2</sup>  
(Redevelopment is the creation and/or replacement of impervious surface on an already developed site).
- Others \_\_\_\_\_

Name of Person Completing this Form: Chelisa Pack (Agent on behalf of Pardee Homes)

Role:  Property Owner  Contractor  Architect  Engineer  Other \_\_\_\_\_

Email: chelisap@projectdesign.com Phone: (619) 881-2575

Signature:  Date Completed: 9/9/2020

Answer each section below, starting with Section 1 and progressing through each section. Additional information for determining the requirements is found in the Chula Vista BMP Design Manual available on the City's website at <http://www.chulavistaca.gov/departments/public-works/services/storm-water-pollution-prevention/documents-and-reports>.

### SECTION 1: Storm Water BMP Requirements

<p>Does the project consist of <b>one or both</b> of the following:</p> <ul style="list-style-type: none"> <li>Repair or improvements to an existing building or structure that don't alter the size such as: tenant improvements, interior remodeling, electrical work, fire alarm, fire sprinkler system, HVAC work, Gas, plumbing, etc.</li> <li>Routine maintenance activities such as: roof or exterior structure surface replacement; resurfacing existing roadways and parking lots including dig outs, slurry seal, overlay and restriping; repair damaged sidewalks or pedestrian ramps on existing roads without expanding the impervious footprint; routine replacement of damaged pavement, trenching and resurfacing associated with utility work (i.e. sewer, water, gas or electrical laterals, etc.) and pot holing or geotechnical investigation borings.</li> </ul>	<input type="checkbox"/> Yes	<p>Project is <b>NOT</b> Subject to Permanent Storm Water BMP requirements.</p> <p><b>BUT IS</b> subject to Construction BMP requirements. Review &amp; sign "Construction Storm Water BMP Certification Statement" on page 2.</p>
	<input checked="" type="checkbox"/> No	<p><b>Continue to Section 2, page 3.</b></p>



## Construction Storm Water BMP Certification Statement

The following stormwater quality protection measures are required by City Chula Vista Municipal Code Chapter 14.20 and the City's Jurisdictional Runoff Management Program.

1. All applicable construction BMPs and non-stormwater discharge BMPs shall be installed and maintained for the duration of the project in accordance with the Appendix K "Construction BMP Standards" of the Chula Vista BMP Design Manual.
2. Erosion control BMPs shall be implemented for all portions of the project area in which no work has been done or is planned to be done over a period of 14 or more days. All onsite drainage pathways that convey concentrated flows shall be stabilized to prevent erosion.
3. Run-on from areas outside the project area shall be diverted around work areas to the extent feasible. Run-on that cannot be diverted shall be managed using appropriate erosion and sediment control BMPs.
4. Sediment control BMPs shall be implemented, including providing fiber rolls, gravel bags, or other equally effective BMPs around the perimeter of the project to prevent transport of soil and sediment offsite. Any sediment tracked onto offsite paved areas shall be removed via sweeping at least daily.
5. Trash and other construction wastes shall be placed in a designated area at least daily and shall be disposed of in accordance with applicable requirements.
6. Materials shall be stored to avoid being transported in storm water runoff and non-storm water discharges. Concrete washout shall be directed to a washout area and shall not be washed out to the ground.
7. Stockpiles and other sources of pollutants shall be covered when the chance of rain within the next 48 hours is at least 50%.

I certify that the stormwater quality protection measures listed above will be implemented at the project described on Intake Form. I understand that failure to implement these measures may result in monetary penalties or other enforcement actions. This certification is signed under penalty of perjury and does not require notarization.

Name: \_\_\_\_\_ Title: \_\_\_\_\_

Signature: \_\_\_\_\_ Date: \_\_\_\_\_

**Section 2: Determine if Project is a Standard Project or Priority Development Project**

Is the project in any of the following categories, (a) through (j)?

(a) New development that **creates 10,000 square feet** or more of impervious surfaces (collectively over the entire project site). This includes commercial, industrial, residential, mixed-use, and public development projects on public or private land.  Yes  No

(b) Redevelopment project that **creates and/or replaces 5,000 square feet** or more of impervious surface (collectively over the entire project site on an existing site of 10,000 square feet or more of impervious surfaces). This includes commercial, industrial, residential, mixed-use, and public development projects on public or private land.  Yes  No

(c) New development or redevelopment projects that **creates and/or replaces a combined total of 5,000 square feet** or more of impervious surface (collectively over the entire project site) and support one or more of the following uses:  Yes  No

(i) **Restaurant.** This category is defined as a facility that sells prepared foods and drinks for consumption, including stationary lunch counters and refreshment stands selling prepared foods and drinks for immediate consumption (Standard Industrial Classification Code 5812).

(ii) **Hillside development projects.** This category includes development on any natural slope that is twenty-five percent or greater.

(iii) **Parking Lots.** This category is defined as a land area or facility for the temporary parking or storage of motor vehicles used personally, for business, or for commerce.

(iv) **Streets, roads, highways, freeways, and driveways.** This category is defined as any paved impervious surface used for the transportation of automobiles, trucks, motorcycles, and other vehicles.

(d) New development or redevelopment project that **creates and/or replaces 2,500 square feet** or more of impervious surface (collectively over the entire project site), discharging directly to an Environmentally Sensitive Area (ESA). "Discharging directly to" includes flow that is conveyed overland a distance of 200 feet or less from the project to the ESA, or conveyed in a pipe or open channel any distance as an isolated flow from the project to the ESA (i.e. not commingled with flows from adjacent lands).  Yes  No

(e) New development or redevelopment project that creates and/or replaces a combined total of 5,000 square feet or more of impervious surface, that support one or more of the following used:  Yes  No

(i) Automotive repair shops. This category is defined as a facility that is categorized in any one of the following Standard Industrial Classification (SIC) codes: 5013, 5014, 5541, 7532-7534, or 7536-7539.

(ii) Retail gasoline outlets. This category includes retail gasoline outlets that meet the meet one of the following criteria: (a) 5,000 square feet or more or (b) a projected Average Daily Traffic (ADT) of 100 or more vehicles per day.

(f) New development or redevelopment that result in the disturbance of **one or more acres** of land and are expected to generate pollutants post construction. This does not include projects creating less than 5,000 sf of impervious surface and where added landscaping does not require regular use of pesticides and fertilizers, such as slope stabilization using native plants. Calculation of the square footage of impervious surface need not include linear pathways that are for infrequent vehicle use, such as emergency maintenance access or bicycle pedestrian use, if they are built with pervious surfaces or if they sheet flow to surrounding pervious surfaces.  Yes  No

**The project is (select one):**

If "No" is checked for every category in Section 2, **Project is "Standard Development Project"**. Site design and source control BMP requirements apply. **Complete and submit Standard SWQMP** (refer to Chapter 4 & Appendix E of the BMP Design Manual for guidance). Continue to Section 4.

If "Yes" is checked for ANY category in Section 2, **Project is "Priority Development Project (PDP)"**. Complete below, if applicable, and continue to Section 3.



**SECTION 4: Construction Storm Water BMP Requirements:**

All construction sites are required to implement construction BMPs in accordance with the performance standards in the BMP Design Manual. Some sites are additionally required to obtain coverage under the State Construction General Permit (CGP), which is administered by the State Water Resource Control Board.

1. Does the project include Building/Grading/Construction permits proposing less than 5,000 square feet of ground disturbance and has less than 5-foot elevation change over the entire project area?

Yes; review & sign Construction Storm Water Certification Statement, skip questions 2-4  No; next question

2. Does the project propose construction or demolition activity, including but not limited to, clearing grading, grubbing, excavation, or other activity that results in ground disturbance of less than one acre and more than 5,000 square feet?

Yes. complete & submit Construction Storm Water Pollution Control Plan (CSWPCP), skip questions 3-4  No; next question

3. Does the project results in disturbance of an acre or more of total land area and are considered regular maintenance projects performed to maintain original line and grade, hydraulic capacity, or original purpose of the facility? (Projects such as sewer/storm drain/utility replacement)

Yes. complete & submit Construction Storm Water Pollution Control Plan (CSWPCP), skip question 4  No; next question

4. Is the project proposing land disturbance greater than or equal to one acre OR the project is part of a larger common plan of development disturbing 1 acre or more?

Yes; Storm Water Pollution Prevention Plan (SWPPP) is required. Refer to online CASQA or Caltrans Template. Visit the SWRCB web site at [http://www.waterboards.ca.gov/water\\_issues/programs/stormwater/construction.shtml](http://www.waterboards.ca.gov/water_issues/programs/stormwater/construction.shtml).

Note: for Projects that result in disturbance of one to five acres of total land area and can demonstrate that there will be no adverse water quality impacts by applying for a Construction Rainfall Erosivity Waiver, may be allowed to submit a CSWPCP in lieu of a SWPPP.

Project Name/\_\_\_\_\_

# HMP Exemption Exhibit

Attach this Exhibit (if Applicable) that shows direct storm water runoff discharge from the project site to HMP exempt area. Include project area, applicable underground storm drains line and/or concrete lined channels, outfall information and exempt waterbody. Reference applicable drawing number(s). **Exhibit must be provided on 11"x17" or larger paper.**

# Nakano

Project Name: \_\_\_\_\_

Site Information Checklist		Form I-3B
Project Summary Information		
Project Name	Nakano	
Project Address	North of the intersection of Dennergy Rd & Regatta Lane, Chula Vista, CA 92154	
Assessor's Parcel Number(s) (APN(s))	624-071-02	
Permit Application Number		
Project Watershed	<input checked="" type="checkbox"/> San Diego Bay	
Hydrologic Subarea name with Numeric Identifier up to two decimal places	Select One: <input type="checkbox"/> Pueblo San Diego 908 <input type="checkbox"/> Sweetwater 909 <input checked="" type="checkbox"/> Otay 910	
Project Area (total area of Assessor's Parcel(s) associated with the project or total area of the right-of-way)	<u>23.77</u> Acres ( <u>1,035,418</u> Square Feet)	
Area to be Disturbed by the Project (Project Footprint)	<u>20.30</u> Acres ( <u>884,389</u> Square Feet)	
Project Proposed Impervious Area (subset of Project Footprint)	<u>13.00</u> Acres ( <u>566,445</u> Square Feet)	
Project Proposed Pervious Area (subset of Project Footprint)	<u>4.45</u> Acres ( <u>198,057</u> Square Feet)	
Note: Proposed Impervious Area + Proposed Pervious Area = Area to be Disturbed by the Project. This may be less than the Parcel Area.		
The proposed increase or decrease in impervious area in the proposed condition as compared to the pre-project condition	<u>64</u> %	

Form I-3B Page 3 of 10	
Description of Existing Site Condition and Drainage Patterns	
<p>Current Status of the Site (select all that apply):</p> <ul style="list-style-type: none"> <li><input type="checkbox"/> Existing development</li> <li><input checked="" type="checkbox"/> Previously graded but not built out</li> <li><input type="checkbox"/> Demolition completed without new construction</li> <li><input type="checkbox"/> Agricultural or other non-impervious use</li> <li><input checked="" type="checkbox"/> Vacant, undeveloped/natural</li> </ul> <p>Description / Additional Information:</p> <p><b>Presently the site is undeveloped, mostly vacant and natural other than small utilities facilities.</b></p>	
<p>Existing Land Cover Includes (select all that apply):</p> <ul style="list-style-type: none"> <li><input checked="" type="checkbox"/> Vegetative Cover</li> <li><input type="checkbox"/> Non-Vegetated Pervious Areas</li> <li><input type="checkbox"/> Impervious Areas</li> </ul> <p>Description / Additional Information:</p> <p><b>Presently the site is undeveloped and natural with grassland, hillside, utilities facilities and a small dirt path traversing the property.</b></p>	
<p>Underlying Soil belongs to Hydrologic Soil Group (select all that apply):</p> <ul style="list-style-type: none"> <li><input type="checkbox"/> NRCS Type A</li> <li><input type="checkbox"/> NRCS Type B</li> <li><input checked="" type="checkbox"/> NRCS Type C</li> <li><input checked="" type="checkbox"/> NRCS Type D</li> </ul>	
<p>Approximate Depth to Groundwater (GW):</p> <ul style="list-style-type: none"> <li><input type="checkbox"/> GW Depth &lt; 5 feet</li> <li><input type="checkbox"/> 5 feet &lt; GW Depth &lt; 10 feet</li> <li><input type="checkbox"/> 10 feet &lt; GW Depth &lt; 20 feet</li> <li><input checked="" type="checkbox"/> GW Depth &gt; 20 feet</li> </ul>	
<p>Existing Natural Hydrologic Features (select all that apply):</p> <ul style="list-style-type: none"> <li><input checked="" type="checkbox"/> Watercourses</li> <li><input type="checkbox"/> Seeps</li> <li><input type="checkbox"/> Springs</li> <li><input type="checkbox"/> Wetlands</li> <li><input type="checkbox"/> None</li> </ul> <p>Description / Additional Information:</p> <p><b>Runon from the south flows north along the eastern edge of the project in an existing natural channel which is within a CDFW jurisdictional area.</b></p>	

Project Name: \_\_\_\_\_

## Form I-3B Page 3 of 10

**Description of Existing Site Drainage Patterns**

How is storm water runoff conveyed from the site? At a minimum, this description should answer:

1. whether existing drainage conveyance is natural or urban;
2. Is runoff from offsite conveyed through the site? if yes, quantify all offsite drainage areas, design flows, and locations where offsite flows enter the project site, and summarize how such flows are conveyed through the site;
3. Provide details regarding existing project site drainage conveyance network, including any existing storm drains, concrete channels, swales, detention facilities, storm water treatment facilities, natural or constructed channels; and
4. Identify all discharge locations from the existing project site along with a summary of conveyance system size and capacity for each of the discharge locations. Provide summary of the pre-project drainage areas and design flows to each of the existing runoff discharge locations.

Describe existing site drainage patterns:

1. The existing drainage conveyance is mostly natural with minimal drainage improvements.
2. There are about 10.1 acres of runoff areas draining onto the site from upstream areas from Kaiser Permanente and flows to the northeast of project site through natural conveyance to the northerly property line. Most of this portion of the runoff from the north flows through the site and also along the western edge of the project site. A pipe will convey most of the runoff flows through the site and out the center outfall of the proposed conditions. A low flow splitter will be utilized to maintain flow in the natural conveyance along the east portion of the project.
3. There are currently minimal drainage improvements within the project boundary.
4. The majority of the project drains to the north towards Otay River. The onsite portion sheet flows across the property to the north which eventually flows to Otay River. A clear natural channel is not defined though.

Refer to the project drainage study for additional information.



**Form I-3B Page 4 of 10**

**Description of Proposed Site Development and Drainage Patterns**

Project Description / Proposed Land Use and/or Activities:  
The Nakano project proposes a total of 61 detached condominiums, 84 duplexes, and 70 multi-family dwelling units. Two biofiltration basins will be installed, one in the northwest corner of the site and center east side of the project as well as a detention vault and modular wetland unit for water quality treatment. Two mini parks will be constructed in the center north and northwest locations of the project.

List/describe proposed impervious features of the project (e.g., buildings, roadways, parking lots, courtyards, athletic courts, other impervious features):  
The impervious features of the project consist of building roofs, driveways, streets, concrete sidewalks, and other miscellaneous improvements.

List/describe proposed pervious features of the project (e.g., landscape areas):  
The pervious features of the project consist of landscaping areas, two biofiltration basins and a proposed park.

Does the project include grading and changes to site topography?  
 Yes  
 No

Description / Additional Information:  
The site will be mass graded to build the residential units, but the proposed grading maintains similar slope to existing condition.

Project Name: \_\_\_\_\_

Form I-3B Page 5 of 10

Does the project include changes to site drainage (e.g., installation of new storm water conveyance systems)?

- Yes
- No

If yes, provide details regarding the proposed project site drainage conveyance network, including storm drains, concrete channels, swales, detention facilities, storm water treatment facilities, natural or constructed channels, and the method for conveying offsite flows through or around the proposed project site. Identify all discharge locations from the proposed project site along with a summary of the conveyance system size and capacity for each of the discharge locations. Provide a summary of pre- and post-project drainage areas and design flows to each of the runoff discharge locations. Reference the drainage study for detailed calculations.

Describe proposed site drainage patterns:

The project site will include a storm drain system consisting of roof drains, inlets, pipes, brow ditches, and water quality features/detention basin.  
The proposed drainage improvements include private storm drain improvements serving the private development lots. The site generally maintains the natural drainage, flowing to the north.

Project Name: \_\_\_\_\_

Form I-3B Page 6 of 10

Identify whether any of the following features, activities, and/or pollutant source areas will be present (select all that apply):

- On-site storm drain inlets
- Interior floor drains and elevator shaft sump pumps
- Interior parking garages
- Need for future indoor & structural pest control
- Landscape/Outdoor Pesticide Use
- Pools, spas, ponds, decorative fountains, and other water features
- Food service
- Refuse areas
- Industrial processes
- Outdoor storage of equipment or materials
- Vehicle and Equipment Cleaning
- Vehicle/Equipment Repair and Maintenance
- Fuel Dispensing Areas
- Loading Docks
- Fire Sprinkler Test Water
- Miscellaneous Drain or Wash Water
- Plazas, sidewalks, and parking lots

Description / Additional Information:

The project will have features typical of proposed land uses including parks, residential units with landscaped areas, sidewalks and onsite storm drain inlets.

Project Name: \_\_\_\_\_

**Form I-3B Page 7 of 10**

**Identification and Narrative of Receiving Water and Pollutants of Concern**

Describe flow path of storm water from the project site discharge location(s), through urban storm conveyance systems as applicable, to receiving creeks, rivers, and lagoons as applicable, and ultimate discharge to the Pacific Ocean (or bay, lagoon, lake or reservoir, as applicable):

The majority of the project drains to the north and sheet flows towards Otay River. There is no storm drain conveyance system or facilities onsite. Otay River then flows to the San Diego Bay.

List any 303(d) impaired water bodies within the path of storm water from the project site to the Pacific Ocean (or bay, lagoon, lake or reservoir, as applicable), identify the pollutant(s)/stressor(s) causing impairment, and identify any TMDLs and/or Highest Priority Pollutants from the WQIP for the impaired water bodies:

303(d) Impaired Water Body	Pollutant(s)/Stressor(s)	TMDLs / WQIP Highest Priority Pollutant
San Diego Bay	Mercury, PAHs, PCBs	Mercury, PAHs, PCBs

**Identification of Project Site Pollutants\***

\*Identification of project site pollutants is only required if flow-thru treatment BMPs are implemented onsite in lieu of retention or biofiltration BMPs (note the project must also participate in an alternative compliance program unless prior lawful approval to meet earlier PDP requirements is demonstrated)

Identify pollutants expected from the project site based on all proposed use(s) of the site (see BMP Design Manual Appendix B.6):

Pollutant	Not Applicable to the Project Site	Expected from the Project Site	Also a Receiving Water Pollutant of Concern
Sediment	<input type="checkbox"/>	<input type="checkbox"/>	<input type="checkbox"/>
Nutrients	<input type="checkbox"/>	<input type="checkbox"/>	<input type="checkbox"/>
Heavy Metals	<input type="checkbox"/>	<input type="checkbox"/>	<input type="checkbox"/>
Organic Compounds	<input type="checkbox"/>	<input type="checkbox"/>	<input type="checkbox"/>
Trash & Debris	<input type="checkbox"/>	<input type="checkbox"/>	<input type="checkbox"/>
Oxygen Demanding Substances	<input type="checkbox"/>	<input type="checkbox"/>	<input type="checkbox"/>
Oil & Grease	<input type="checkbox"/>	<input type="checkbox"/>	<input type="checkbox"/>
Bacteria & Viruses	<input type="checkbox"/>	<input type="checkbox"/>	<input type="checkbox"/>
Pesticides	<input type="checkbox"/>	<input type="checkbox"/>	<input type="checkbox"/>



Form I-3B Page 8 of 10

**Hydromodification Management Requirements**

Do hydromodification management requirements apply (see Section 1.6)?

- Yes, hydromodification management flow control structural BMPs required.
- No, the project will discharge runoff directly to existing underground storm drains discharging directly to water storage reservoirs, lakes, enclosed embayments, or the Pacific Ocean.
- No, the project will discharge runoff directly to conveyance channels whose bed and bank are concrete-lined all the way from the point of discharge to water storage reservoirs, lakes, enclosed embayments, or the Pacific Ocean.
- No, the project will discharge runoff directly to an area identified as appropriate for an exemption by the WMAA for the watershed in which the project resides.

Description / Additional Information (to be provided if a 'No' answer has been selected above):

Note: If “No” answer has been selected the SWQMP must include an exhibit that shows the storm water conveyance system from the project site to an exempt water body. The exhibit should include details about the conveyance system and the outfall to the exempt water body.

**Critical Coarse Sediment Yield Areas\***

**\*This Section only required if hydromodification management requirements apply**

Based on Section 6.2 and Appendix H does CCSYA exist on the project footprint or in the upstream area draining through the project footprint?

- Yes
- No

Description / Additional Information:

Yes, a small portion of CCSYAs exist on the project footprint. One CCSYA area is draining onto the project will be mitigated by using the avoidance metric per Section H.2.1 of the City of Chula Vista BMP Design Manual. The disturbed onsite CCSYA Area of 6,441 SF is less than 5% of the area draining to POC 2 (172,005 SF). The CCSYA area is 3.7% of the area draining to the POC.

The second CCSYA area is a hillslope area and will be bypassed and flow into a drainage ditch to the northeast corner of the project. The drainage ditch will convey bed sediment from the hillslope to the downstream waters by maintaining a peak velocity of greater than 3 ft/s for the 2-year, 24 hour runoff event per Section H.3.1. Continued below.



Project Name: \_\_\_\_\_

**Form I-3B Page 9 of 10**

**Flow Control for Post-Project Runoff\***  
**\*This Section only required if hydromodification management requirements apply**

List and describe point(s) of compliance (POCs) for flow control for hydromodification management (see Section 6.3.1). For each POC, provide a POC identification name or number correlating to the project's HMP Exhibit and a receiving channel identification name or number correlating to the project HMP Exhibit.

POC 1 is located in the northwest portion of the project site.

POC 2 is located in the center north area of the project site.

Has a geomorphic assessment been performed for the receiving channel(s)?

- No, the low flow threshold is 0.1Q2 (default low flow threshold)
- Yes, the result is the low flow threshold is 0.1Q2
- Yes, the result is the low flow threshold is 0.3Q2
- Yes, the result is the low flow threshold is 0.5Q2

If a geomorphic assessment has been performed, provide title, date, and preparer:

Discussion / Additional Information: (optional)



Project Name: \_\_\_\_\_

**Form I-3B Page 10 of 10**

**Other Site Requirements and Constraints**

When applicable, list other site requirements or constraints that will influence storm water management design, such as zoning requirements including setbacks and open space, or local codes governing minimum street width, sidewalk construction, allowable pavement types, and drainage requirements.

**Optional Additional Information or Continuation of Previous Sections As Needed**

This space provided for additional information or continuation of information from previous sections as needed.

Project Name: \_\_\_\_\_

Source Control BMP Checklist for All Development Projects		Form I-4	
<p>All development projects must implement source control BMPs. Refer to <b>Chapter 4</b> and <b>Appendix E</b> of the BMP Design Manual for information to implement BMPs shown in this checklist.</p> <p><b>Note: All selected BMPs must be shown on the site/construction plans.</b></p> <p>Answer each category below pursuant to the following:</p> <ul style="list-style-type: none"> <li>• "Yes" means the project will implement the source control BMP as described in Chapter 4 and/or Appendix E of the BMP Design Manual. Discussion / justification is not required.</li> <li>• "No" means the BMP is applicable to the project but it is not feasible to implement. Discussion / justification must be provided.</li> <li>• "N/A" means the BMP is not applicable at the project site because the project does not include the feature that is addressed by the BMP (e.g., the project has no outdoor materials storage areas). Discussion / justification may be provided.</li> </ul>			
Source Control Requirement	Applied?		
4.2.1 Prevention of Illicit Discharges into the MS4	<input checked="" type="checkbox"/> Yes	<input type="checkbox"/> No	<input type="checkbox"/> N/A
Discussion / justification if 4.2.1 not implemented:			
4.2.2 Storm Drain Stenciling or Signage	<input checked="" type="checkbox"/> Yes	<input type="checkbox"/> No	<input type="checkbox"/> N/A
Discussion / justification if 4.2.2 not implemented:			
4.2.3 Protect Outdoor Materials Storage Areas from Rainfall, Run-On, Runoff, and Wind Dispersal	<input type="checkbox"/> Yes	<input type="checkbox"/> No	<input checked="" type="checkbox"/> N/A
Discussion / justification if 4.2.3 not implemented: <b>No outdoor material storage areas planned.</b>			
4.2.4 Protect Materials Stored in Outdoor Work Areas from Rainfall, Run-On, Runoff, and Wind Dispersal	<input type="checkbox"/> Yes	<input type="checkbox"/> No	<input checked="" type="checkbox"/> N/A
Discussion / justification if 4.2.4 not implemented:			
4.2.5 Protect Trash Storage Areas from Rainfall, Run-On, Runoff, and Wind Dispersal	<input checked="" type="checkbox"/> Yes	<input type="checkbox"/> No	<input type="checkbox"/> N/A
Discussion / justification if 4.2.5 not implemented: <b>Trash storage areas will be located indoors and/or trash receptacles with lids will be used.</b>			



Project Name: \_\_\_\_\_

Source Control BMP Checklist for All Development Projects		Form I-4 (Page 2 of 2)	
<b>4.2.6</b> Additional BMPs Based on Potential Sources of Runoff Pollutants (must answer for each source listed below)	<input checked="" type="checkbox"/> Yes	<input type="checkbox"/> No	<input type="checkbox"/> N/A
SC-A Onsite storm drain inlets	<input checked="" type="checkbox"/> Yes	<input type="checkbox"/> No	<input type="checkbox"/> N/A
SC-B Interior floor drains and elevator shaft sump pumps	<input type="checkbox"/> Yes	<input type="checkbox"/> No	<input checked="" type="checkbox"/> N/A
SC-C Interior parking garages	<input type="checkbox"/> Yes	<input type="checkbox"/> No	<input checked="" type="checkbox"/> N/A
SC-D1 Need for future indoor & structural pest control	<input type="checkbox"/> Yes	<input type="checkbox"/> No	<input checked="" type="checkbox"/> N/A
SD-D2 Landscape/outdoor pesticide use	<input checked="" type="checkbox"/> Yes	<input type="checkbox"/> No	<input type="checkbox"/> N/A
SC-E Pools, spas, ponds, decorative fountains, and other water features	<input type="checkbox"/> Yes	<input type="checkbox"/> No	<input checked="" type="checkbox"/> N/A
SC-F Food Service	<input type="checkbox"/> Yes	<input type="checkbox"/> No	<input checked="" type="checkbox"/> N/A
SC-G Refuse areas	<input checked="" type="checkbox"/> Yes	<input type="checkbox"/> No	<input type="checkbox"/> N/A
SC-H Industrial processes	<input type="checkbox"/> Yes	<input type="checkbox"/> No	<input checked="" type="checkbox"/> N/A
SC-I Outdoor storage of equipment or materials	<input type="checkbox"/> Yes	<input type="checkbox"/> No	<input checked="" type="checkbox"/> N/A
SC-J Vehicle and equipment cleaning	<input type="checkbox"/> Yes	<input type="checkbox"/> No	<input checked="" type="checkbox"/> N/A
SC-K Vehicle/equipment repair and maintenance	<input type="checkbox"/> Yes	<input type="checkbox"/> No	<input checked="" type="checkbox"/> N/A
SC-L Fuel dispensing areas	<input type="checkbox"/> Yes	<input type="checkbox"/> No	<input checked="" type="checkbox"/> N/A
SC-M Loading docks	<input type="checkbox"/> Yes	<input type="checkbox"/> No	<input checked="" type="checkbox"/> N/A
SC-N Fire sprinkler test water	<input checked="" type="checkbox"/> Yes	<input type="checkbox"/> No	<input type="checkbox"/> N/A
SC-O Miscellaneous drain or wash water	<input checked="" type="checkbox"/> Yes	<input type="checkbox"/> No	<input type="checkbox"/> N/A
SC-P Plazas, sidewalks, and parking lots	<input checked="" type="checkbox"/> Yes	<input type="checkbox"/> No	<input type="checkbox"/> N/A
SC-Q: Large Trash Generating Facilities	<input type="checkbox"/> Yes	<input type="checkbox"/> No	<input checked="" type="checkbox"/> N/A
SC-R: Animal Facilities	<input type="checkbox"/> Yes	<input type="checkbox"/> No	<input checked="" type="checkbox"/> N/A
SC-S: Plant Nurseries and Garden Centers	<input type="checkbox"/> Yes	<input type="checkbox"/> No	<input checked="" type="checkbox"/> N/A
SC-T: Automotive Facilities	<input type="checkbox"/> Yes	<input type="checkbox"/> No	<input checked="" type="checkbox"/> N/A
Discussion / justification if 4.2.6 not implemented. Justification must be provided for all "No" answers shown above.			

Project Name.: \_\_\_\_\_

Site Design BMP Checklist for All Development Projects		Form I-5	
<p>All development projects must implement site design BMPs where applicable and feasible. See <b>Chapter 4 and Appendix E</b> of the manual for information to implement site design BMPs shown in this checklist. <b>Note: All selected BMPs must be shown on the site/construction plans.</b></p> <p>Answer each category below pursuant to the following.</p> <ul style="list-style-type: none"> <li>• "Yes" means the project will implement the site design BMP as described in Chapter 4 and/or Appendix E of the manual. Discussion / justification is not required.</li> <li>• "No" means the BMP is applicable to the project but it is not feasible to implement. Discussion / justification must be provided.</li> <li>• "N/A" means the BMP is not applicable at the project site because the project does not include the feature that is addressed by the BMP (e.g., the project site has no existing natural areas to conserve). Discussion / justification may be provided.</li> </ul>			
Site Design Requirement	Applied?		
4.3.1 Maintain Natural Drainage Pathways and Hydrologic Features	<input checked="" type="checkbox"/> Yes	<input type="checkbox"/> No	<input type="checkbox"/> N/A
4.3.2 Conserve Natural Areas, Soils, and Vegetation	<input checked="" type="checkbox"/> Yes	<input type="checkbox"/> No	<input type="checkbox"/> N/A
4.3.3 Minimize Impervious Area	<input checked="" type="checkbox"/> Yes	<input type="checkbox"/> No	<input type="checkbox"/> N/A
4.3.4 Minimize Soil Compaction	<input checked="" type="checkbox"/> Yes	<input type="checkbox"/> No	<input type="checkbox"/> N/A
4.3.5 Impervious Area Dispersion	<input checked="" type="checkbox"/> Yes	<input type="checkbox"/> No	<input type="checkbox"/> N/A

Nakano

Project Name/Address/N \_\_\_\_\_

Site Design BMP Checklist for All Development Projects		Form I-5		
Site Design Requirement	Applied?			
4.3.6 Runoff Collection	<input type="checkbox"/> Yes	<input type="checkbox"/> No	<input checked="" type="checkbox"/> N/A	
4.3.7 Landscaping with Native or Drought Tolerant Species	<input checked="" type="checkbox"/> Yes	<input type="checkbox"/> No	<input type="checkbox"/> N/A	
4.3.8 Harvesting and Using Precipitation	<input type="checkbox"/> Yes	<input checked="" type="checkbox"/> No	<input type="checkbox"/> N/A	
Discussion / justification for all "No" answers shown above: Harvest and Reuse not feasible per calculations in Form I-7.				

Project Name: \_\_\_\_\_

Summary of PDP Structural BMPs	Form I-6
<b>PDP Structural BMPs</b>	
<p>All PDPs must implement structural BMPs for storm water pollutant control (see <b>Chapter 5 of the manual</b>). Selection of PDP structural BMPs for storm water pollutant control must be based on the selection process described in <b>Chapter 5</b>. PDPs subject to hydromodification management requirements must also implement structural BMPs for flow control for hydromodification management (see <b>Chapter 6 of the manual</b>). Both storm water pollutant control and flow control for hydromodification management can be achieved within the same structural BMP(s).</p> <p>PDP structural BMPs must be verified by City at the completion of construction. This may include requiring the project owner or project owner's representative to certify construction of the structural BMPs (see Section 1.12 of the manual). PDP structural BMPs must be maintained into perpetuity (see <b>Section 7 of the manual</b>).</p> <p>Use this form to provide narrative description of the general strategy for structural BMP implementation at the project site in the box below. Then complete the PDP structural BMP summary information sheet (page <b>3 of this form</b>) for each structural BMP within the project (copy the BMP summary information page as many times as needed to provide summary information for each individual structural BMP).</p>	
<p>Describe the general strategy for structural BMP implementation at the site. This information must describe how the steps for selecting and designing storm water pollutant control BMPs presented in Section 5.1 of the manual were followed, and the results (type of BMPs selected). For projects requiring hydromodification flow control BMPs, indicate whether pollutant control and flow control BMPs are integrated or separate.</p> <p>The project geotechnical engineer has deemed the entire site to be a no-infiltration site for stormwater purposes. Harvest and reuse calculations showed that stormwater reuse was deemed infeasible for this project site. Due to the "no infiltration" conditions, two biofiltration basins and a detention vault in a combination with a Modular Wetland Unit will be used for pollutant control and volume retention requirements. Some slopes to the western perimeter will be graded and drain directly off site without any imperviousness and will therefore be treated as self-mitigating. Refer to Attachment 1A for the identification of the areas.</p> <p>The biofiltration basins combined with the detention vault and the Modular Wetland Unit will individually meet pollutant treatment requirements for the drainage areas. The volume retention is analyzed for the entire site and will be met with a combination of biofiltration basins, and impervious dispersion of hardscape to landscape areas. These dispersion areas utilized for the volume retention credit are located within the non-contiguous sidewalks and adjacent landscaping strips along the Private Drives throughout the project. Refer to the DMA exhibit for further information. The dispersion to landscape area will be less than 10 feet, but it meets the criteria when the contributing flow path length of the impervious area / pervious area width is less than or equal to 2 and a maximum slope of 5% ( See page B-48 of the 2021 City of Chula Vista BMP Design Manual)</p>	

Project Name: \_\_\_\_\_

Summary of PDP Structural BMPs	Form I-6
<b>PDP Structural BMPs</b>	
<p>All PDPs must implement structural BMPs for storm water pollutant control (see <b>Chapter 5 of the manual</b>). Selection of PDP structural BMPs for storm water pollutant control must be based on the selection process described in <b>Chapter 5</b>. PDPs subject to hydromodification management requirements must also implement structural BMPs for flow control for hydromodification management (see <b>Chapter 6 of the manual</b>). Both storm water pollutant control and flow control for hydromodification management can be achieved within the same structural BMP(s).</p> <p>PDP structural BMPs must be verified by City at the completion of construction. This may include requiring the project owner or project owner's representative to certify construction of the structural BMPs (see Section 1.12 of the manual). PDP structural BMPs must be maintained into perpetuity (see <b>Section 7 of the manual</b>).</p> <p>Use this form to provide narrative description of the general strategy for structural BMP implementation at the project site in the box below. Then complete the PDP structural BMP summary information sheet (page <b>3 of this form</b>) for each structural BMP within the project (copy the BMP summary information page as many times as needed to provide summary information for each individual structural BMP).</p>	
<p>Describe the general strategy for structural BMP implementation at the site. This information must describe how the steps for selecting and designing storm water pollutant control BMPs presented in Section 5.1 of the manual were followed, and the results (type of BMPs selected). For projects requiring hydromodification flow control BMPs, indicate whether pollutant control and flow control BMPs are integrated or separate.</p> <p>The project geotechnical engineer has deemed the entire site to be a no-infiltration site for stormwater purposes. Harvest and reuse calculations showed that stormwater reuse was deemed infeasible for this project site. Due to the "no infiltration" conditions, two biofiltration basins and a detention vault in a combination with a Modular Wetland Unit will be used for pollutant control and volume retention requirements. Some slopes to the western perimeter will be graded and drain directly off site without any imperviousness and will therefore be treated as self-mitigating. Refer to Attachment 1A for the identification of the areas.</p> <p>The biofiltration basins combined with the detention vault and the Modular Wetland Unit will individually meet pollutant treatment requirements for the drainage areas. The volume retention is analyzed for the entire site and will be met with a combination of biofiltration basins, and impervious dispersion of hardscape to landscape areas. These dispersion areas utilized for the volume retention credit are located within the non-contiguous sidewalks and adjacent landscaping strips along the Private Drives throughout the project. Refer to the DMA exhibit for further information. The dispersion to landscape area will be less than 10 feet, but it meets the criteria when the contributing flow path length of the impervious area / pervious area width is less than or equal to 2 and a maximum slope of 5% ( See page B-48 of the 2021 City of Chula Vista BMP Design Manual)</p>	

Project Name: \_\_\_\_\_

Summary of PDP Structural BMPs	Form I-6
<b>PDP Structural BMPs</b>	
<p>All PDPs must implement structural BMPs for storm water pollutant control (see <b>Chapter 5 of the manual</b>). Selection of PDP structural BMPs for storm water pollutant control must be based on the selection process described in <b>Chapter 5</b>. PDPs subject to hydromodification management requirements must also implement structural BMPs for flow control for hydromodification management (see <b>Chapter 6 of the manual</b>). Both storm water pollutant control and flow control for hydromodification management can be achieved within the same structural BMP(s).</p> <p>PDP structural BMPs must be verified by City at the completion of construction. This may include requiring the project owner or project owner's representative to certify construction of the structural BMPs (see Section 1.12 of the manual). PDP structural BMPs must be maintained into perpetuity (see <b>Section 7 of the manual</b>).</p> <p>Use this form to provide narrative description of the general strategy for structural BMP implementation at the project site in the box below. Then complete the PDP structural BMP summary information sheet (page <b>3 of this form</b>) for each structural BMP within the project (copy the BMP summary information page as many times as needed to provide summary information for each individual structural BMP).</p>	
<p>Describe the general strategy for structural BMP implementation at the site. This information must describe how the steps for selecting and designing storm water pollutant control BMPs presented in Section 5.1 of the manual were followed, and the results (type of BMPs selected). For projects requiring hydromodification flow control BMPs, indicate whether pollutant control and flow control BMPs are integrated or separate.</p> <p>DMA 1 is the northwest portion of residential units that flows via the gutter system towards a reverse curb outlet and enters a lined biofiltration basin (BMP#1) in the northwest corner of the project site.</p> <p>DMA 3 collects a majority of the onsite project site of residential units and streets. This DMA will be treated by one planted-type modular wetland unit (BMP#3) downstream a detention vault which will detain 2.6DCV with a drawdown time less than 96 hrs. Because the unit is situated downstream of the vault, and the vault detains the water quality capture volume the modular wetland unit is sized based on a volume-basis in combination with the vault. Based on the Percent Capture method, capturing and treating 1.25DCV with a 24 hour drawdown is equivalent to a 2.6 DCV capture with a 96-hour drawdown. The "default" sizing methodology for proprietary biofiltration is 1.5 WQF, but in this case the project will size the BMP based on the percent capture method and the volume-based sizing methodology, to ensure that the vault and proprietary biofiltration downstream of the vault are both sized adequately.</p> <p>DMA 2 collects a portion of the center east project site area and is drained to a lined biofiltration basin (BMP#2).</p>	

Form I-6 Page 3 of 8 (Copy and attach as many as needed)	
<b>Structural BMP ID No.</b> 1	
<b>Construction Plan Sheet No.</b>	
Type of structural BMP: <input type="checkbox"/> Retention by harvest and use (e.g. HU-1, cistern) <input type="checkbox"/> Retention by infiltration basin (INF-1) <input type="checkbox"/> Retention by bioretention (INF-2) <input type="checkbox"/> Retention by permeable pavement (INF-3) <input type="checkbox"/> Partial retention by biofiltration with partial retention (PR-1) <input checked="" type="checkbox"/> Biofiltration (BF-1) <input type="checkbox"/> Flow-thru treatment control with prior lawful approval to meet earlier PDP requirements (provide BMP type/description in discussion section below) <input type="checkbox"/> Flow-thru treatment control included as pre-treatment/forebay for an onsite retention or biofiltration BMP (provide BMP type/description and indicate which onsite retention or biofiltration BMP it serves in discussion section below) <input type="checkbox"/> Flow-thru treatment control with alternative compliance (provide BMP type/description in discussion section below) <input type="checkbox"/> Detention pond or vault for hydromodification management <input type="checkbox"/> Other (describe in discussion section below)	
<b>Purpose:</b> <input type="checkbox"/> Pollutant control only <input type="checkbox"/> Hydromodification control only <input checked="" type="checkbox"/> Combined pollutant control and hydromodification control <input type="checkbox"/> Pre-treatment/forebay for another structural BMP <input type="checkbox"/> Other (describe in discussion section below)	
Who will certify construction of this BMP? Provide name and contact information for the party responsible to sign BMP verification forms if required by the City Engineer (See Section 1.12 of the manual)	Chelisa Pack, RCE 71026 Project Design Consultants 619.235.6471
Who will be the final owner of this BMP?	HOA
Who will maintain this BMP into perpetuity?	HOA
What is the funding mechanism for maintenance?	HOA

Project Name: \_\_\_\_\_

**Form I-6 Page 4 of 8** *(Copy and attach as many as needed)*

**Structural BMP ID No.** 1

**Construction Plan Sheet No.**

Discussion (as needed, must include worksheets showing BMP sizing calculations in the SWQMP):

BMP#1 is a lined biofiltration basin with a bottom footprint of 3,608 SF. This basin consists of 12" of aggregate storage, 3" of ASTM No. 8 Stone, 18" biofiltration media, 3" of ASTM 33 fine aggregate sand and 3" mulch with 6" of ponding.



Project Name: \_\_\_\_\_

**Structural BMP ID No. 2**

**Construction Plan Sheet No.**

Discussion (as needed, must include worksheets showing BMP sizing calculations in the SWQMP):

BMP#2 is a lined biofiltration basin with a bottom footprint of 4,523 SF. This basin consists of 12" of aggregate storage, 3" of ASTM No. 8 Stone, 18" biofiltration media, 3" of ASTM 33 fine aggregate sand and 3" mulch with 6" of ponding.

Project Name: \_\_\_\_\_

**Form I-6 Page 8 of 8** *(Copy and attach as many as needed)***Structural BMP ID No. 3****Construction Plan Sheet No.**

Discussion (as needed, must include worksheets showing BMP sizing calculations in the SWQMP):

BMP#3 is a compact biofiltration BF-3 type Modular Wetland Unit(planted 8-24 model) from the manufacturer Bioclean. This BMP will be downstream of a detention vault. The flow will enter the detention vault with a footprint of 12,736 SF and 5 feet tall. This vault has a capacity of 63,680 CF to detain the capture volume dictated by the drawdown time. The MWS unit model utilizes two orifices within the unit. Two 1.48" orifices within the MWS unit will build enough head in vault to treat the required volume through the unit. The MWS unit is sized based on volume to treat the detained flow out from the water quality capture volume in the upstream vault. In the hydromodification SWMM model an equivalent single 2.2" orifice was modeled to achieve the same flow out. See hydromodification study in Attachment 2. Additional cross sections and calculations can be found in Attachment 1e.

Project Name/\_\_\_\_\_

# **ATTACHMENT 1**

## **Backup for PDP Pollutant Control BMPs**

**Indicate which Items are Included:**

Attachment Sequence	Contents	Checklist
<b>Attachment 1A</b>	<b>DMA Exhibit (Required)</b> See DMA Exhibit Checklist.	<input type="checkbox"/> Included
<b>Attachment 1B</b>	Tabular Summary of DMAs Showing DMA ID matching DMA Exhibit, DMA Area, and DMA Type (Required)*  *Provide table in this Attachment OR on DMA Exhibit in Attachment 1a	<input type="checkbox"/> Included on DMA Exhibit in Attachment 1A  <input type="checkbox"/> Included as Attachment 1B, separate from DMA Exhibit
<b>Attachment 1C</b>	Form I-7, Harvest and Use Feasibility Screening Checklist (Required unless the entire project will use infiltration BMPs) Refer to Appendix B.3-1 of the BMP Design Manual to complete Form I-7.	<input type="checkbox"/> Included  <input type="checkbox"/> Not included because the entire project will use infiltration BMPs
<b>Attachment 1D</b>	Infiltration Feasibility Information. Contents of Attachment 1D depend on the infiltration condition:  <input type="checkbox"/> <b>No Infiltration Condition:</b> <input type="checkbox"/> Infiltration Feasibility Condition <input type="checkbox"/> Letter ( <i>Note: must be stamped &amp; signed by licensed geotechnical engineer</i> ) <input type="checkbox"/> Form I-8A (optional) <input type="checkbox"/> Form I-8B (optional)  <input type="checkbox"/> <b>Partial Infiltration Condition:</b> <input type="checkbox"/> Infiltration Feasibility Condition <input type="checkbox"/> Letter ( <i>Note: must be stamped &amp; signed by licensed geotechnical engineer</i> ) <input type="checkbox"/> Form I-8A <input type="checkbox"/> Form I-8B  <input type="checkbox"/> <b>Full Infiltration Condition:</b> <input type="checkbox"/> Form I-8A <input type="checkbox"/> Form I-8B <input type="checkbox"/> Worksheet C.4-3 <input type="checkbox"/> Form I-9  Refer to Appendices C and D of the BMP Design Manual for guidance.	<input type="checkbox"/> Included  <input type="checkbox"/> Not included because the entire project will use harvest and use BMPs
<b>Attachment 1E</b>	<b>Pollutant Control BMP Design Worksheets/ Calculations (Required)</b> Refer to Appendices B and E of the BMP Design Manual for structural pollutant control BMP design guidelines	<input type="checkbox"/> Included

Project Name/\_\_\_\_\_

**Use this checklist to ensure the required information has been included on the DMA Exhibit:**

The DMA Exhibit must identify all the following:

- Underlying hydrologic soil group
- Approximate depth to groundwater
- Existing natural hydrologic features (watercourses, seeps, springs, wetlands)
- Critical coarse sediment yield areas to be protected
- Existing topography and impervious areas
- Existing and proposed site drainage network and connections to drainage offsite
- Proposed grading
- Proposed impervious features
- Proposed design features and surface treatments used to minimize imperviousness
- Drainage management area (DMA) boundaries, DMA ID numbers, and DMA areas (square footage or acreage), and DMA type (i.e., drains to BMP, self-retaining, or self-mitigating)
- Potential pollutant source areas and corresponding required source controls (see Chapter 4, Appendix E.1, and Form I-3B)
- Structural BMPs (identify location, type of BMP, and size/detail, and include cross-sections)

**ATTACHMENT 1A,1B – DMA MAP**

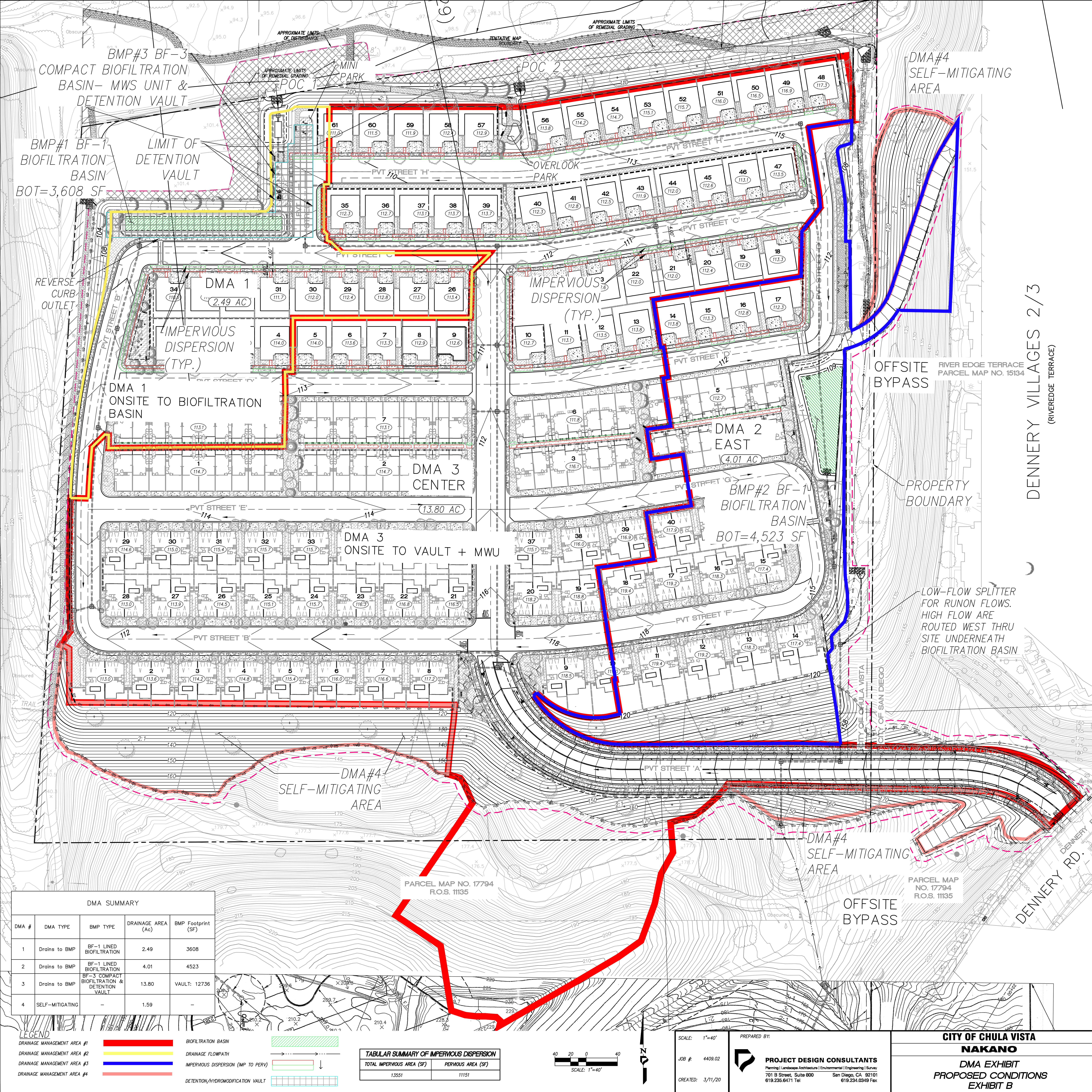

DENNERLY VILLAGES 2/3  
(RIVEREDGE TERRACE)

DMA#4  
SELF-MITIGATING  
AREA

OFFSITE  
BYPASS

RIVER EDGE TERRACE  
PARCEL MAP NO. 15134

PROPERTY  
BOUNDARY

LOW-FLOW SPLITTER  
FOR RUNON FLOWS.  
HIGH FLOW ARE  
ROUTED WEST THRU  
SITE UNDERNEATH  
BIOFILTRATION BASIN

BMP#3 BF-3  
COMPACT BIOFILTRATION  
BASIN- MWS UNIT &  
DETENTION VAULT

BMP#1 BF-1  
BIOFILTRATION  
BASIN  
BOT=3,608 SF

LIMIT OF  
DETENTION  
VAULT

DMA 1  
IMPERVIOUS  
DISPERSION  
(TYP.)  
2.49 AC

DMA 1  
ONSITE TO BIOFILTRATION  
BASIN

DMA 3  
CENTER  
13.80 AC

DMA 3  
ONSITE TO VAULT + MWU

DMA 2  
EAST  
4.01 AC

BMP#2 BF-1  
BIOFILTRATION  
BASIN  
BOT=4,523 SF

DMA#4  
SELF-MITIGATING  
AREA

DMA#4  
SELF-MITIGATING  
AREA

OFFSITE  
BYPASS

DMA SUMMARY				
DMA #	DMA TYPE	BMP TYPE	DRAINAGE AREA (Ac)	BMP Footprint (SF)
1	Drains to BMP	BF-1 LINED BIOFILTRATION	2.49	3608
2	Drains to BMP	BF-1 LINED BIOFILTRATION	4.01	4523
3	Drains to BMP	BF-3 COMPACT BIOFILTRATION & DETENTION VAULT	13.80	VAULT: 12736
4	SELF-MITIGATING	-	1.59	-

LEGEND	
DRAINAGE MANAGEMENT AREA #1	BIOFILTRATION BASIN
DRAINAGE MANAGEMENT AREA #2	DRAINAGE FLOWPATH
DRAINAGE MANAGEMENT AREA #3	IMPERVIOUS DISPERSION (MP TO PERV)
DRAINAGE MANAGEMENT AREA #4	DETENTION/HYDROMODIFICATION VAULT

TABULAR SUMMARY OF IMPERVIOUS DISPERSION	
TOTAL IMPERVIOUS AREA (SF)	PERVIOUS AREA (SF)
13551	11151

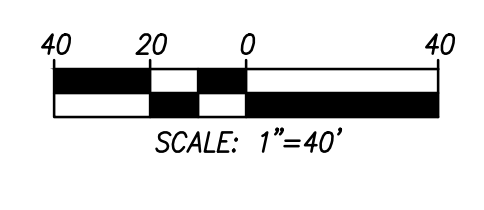

SCALE: 1"=40'

PREPARED BY:



**PROJECT DESIGN CONSULTANTS**  
Planning | Landscape Architecture | Environmental | Engineering | Survey  
701 B Street, Suite 800 San Diego, CA 92101  
619.235.6471 Tel 619.234.0349 Fax

**CITY OF CHULA VISTA**  
**NAKANO**

**DMA EXHIBIT**  
**PROPOSED CONDITIONS**  
**EXHIBIT B**





**ATTACHMENT 1C – HARVEST & USE FEASIBILITY  
CHECKLIST**

Project Name: \_\_\_\_\_

Harvest and Use Feasibility Screening		FORM I-7 (Worksheet B.3-1)
<p>1. Is there a demand for harvested water (check all that apply) at the project site that is reliably present during the wet season?</p> <p><input checked="" type="checkbox"/> Toilet and urinal flushing</p> <p><input checked="" type="checkbox"/> Landscape irrigation</p> <p><input type="checkbox"/> Other: _____</p>		
<p>2. If there is a demand; estimate the anticipated average wet season demand over a period of 36 hours. Guidance for planning level demand calculations for toilet/urinal flushing and landscape irrigation is provided in Section B.3.2.</p> <p>[Provide a summary of calculations here] <span style="float: right; border: 1px solid black; padding: 2px;">Total Demand = 874 + 733 = 1607 CF</span></p> <p>Landscape Irrigation:                      Landscaping area = 4.45 ac Assume Mod. Water Use:                      1470 g/ac/36 hours x 4.45 Ac. = 6541.5 gallons (CF/7.48 gallons) = 874 CF</p> <p>Expected Total Population: 157 x 2.5 = 393                      36 hr Demand = 9.3 gal/res/day x 1.5 days/36 hr x 393 pop = 5482 gallons (CF/7.48 gal) = 733 CF</p>		
<p>3. Calculate the DCV using worksheet B-2.1.</p> <p>[Provide a result here]</p> <p>3 DMAs including Roof from residential units, at grade hardscape and landscape. See BMP Summary Worksheet. DMA = 24,074 CF</p>		
<p>3a. Is the 36-hour demand greater than or equal to the DCV?</p> <p style="text-align: center;">Yes / No ⇔</p> <p style="text-align: center;">↓</p>	<p>3b. Is the 36-hour demand greater than 0.25DCV but less than the full DCV?</p> <p style="text-align: center;">Yes / No ⇔</p> <p style="text-align: center;">↓</p> <p style="text-align: center;">0.25DCV= 6,019 CF</p>	<p>3c. Is the 36-hour demand less than 0.25DCV?</p> <p style="text-align: center;"><span style="border: 1px solid red; padding: 2px;">Yes</span></p> <p style="text-align: center;">↓</p>
<p>Harvest and use appears to be feasible. Conduct more detailed evaluation and sizing calculations to confirm that DCV can be used at an adequate rate to meet drawdown criteria.</p>	<p>Harvest and use may be feasible. Conduct more detailed evaluation and sizing calculations to determine feasibility. Harvest and use may only be able to be used for a portion of the site, or (optionally) the storage may need to be upsized to meet long term capture targets while draining in longer than 36 hours.</p>	<p>Harvest and use is considered to be infeasible.</p>

**Note:** 36-hour demand calculations are for feasibility analysis only, once the feasibility analysis is complete the applicant may be allowed to use a different drawdown time provided they meet the 80 percent of average annual (long term) runoff volume performance standard.



## **ATTACHMENT 1D – INFILTRATION FEASIBILITY LETTER**

Note: This attachment includes two infiltration feasibility letters. The first is formatted for the City of San Diego, and is included for review by the City of San Diego. The second is formatted for the City of Chula Vista, and is included for review by the City of Chula Vista.

**City of San Diego Infiltration Feasibility Letter**  
(For Review by City of San Diego LDR-Engineering and LDR-Geology)



Project No. 07516-42-02  
January 9, 2023

Tri Pointe Homes  
13520 Evening Creek Drive North, Suite 300  
San Diego, California 92128

Attention: Mr. Allen Kashani

Subject: STORMWATER MANAGEMENT RECOMMENDATIONS  
NAKANO  
SAN DIEGO, CALIFORNIA

Reference: *Update Geotechnical Investigation, Nakano Property, Chula Vista, California* prepared by  
Geocon Incorporated dated September 18, 2020 (Project No. 07516-42-02).

Dear Mr. Kashani:

In response to City of San Diego review comments, we have prepared this report to provide stormwater management recommendations for the Nakano project. We previously performed an infiltration study on the property. A summary of our study and stormwater management recommendations are provided in Appendix C of the referenced report. The report was prepared in accordance with City of Chula Vista requirements. Provided herein are stormwater recommendations in accordance with the City of San Diego Stormwater Standards.

Based on the results of our study, full and partial infiltration is considered infeasible due to the presence undocumented fills, low infiltration characteristics, and existing nearby utilities. Basins should utilize a liner to prevent infiltration from causing adverse settlement, migrating to adjacent slopes, utilities, and foundations.

## **STORM WATER MANAGEMENT**

We understand storm water management devices are being proposed in accordance with the current stormwater standards. If not properly constructed, there is a potential for distress to improvements and properties located hydrologically down gradient or adjacent to these devices. Factors such as the amount of water to be detained, its residence time, and soil permeability have an important effect on seepage transmission and the potential adverse impacts that may occur if the storm water management features are not properly designed and constructed. We have not performed a hydrogeological study at the site. If infiltration of storm water runoff occurs, downstream properties and improvements may be subjected

to seeps, springs, slope instability, raised groundwater, movement of foundations and slabs, or other undesirable impacts as a result of water infiltration.

### Hydrologic Soil Group

The United States Department of Agriculture (USDA), Natural Resources Conservation Services, possesses general information regarding the existing soil conditions for areas within the United States. The USDA website also provides the Hydrologic Soil Group. Table 1 presents the descriptions of the hydrologic soil groups. In addition, the USDA website also provides an estimated saturated hydraulic conductivity for the existing soil.

**TABLE 1  
HYDROLOGIC SOIL GROUP DEFINITIONS**

Soil Group	Soil Group Definition
A	Soils having a high infiltration rate (low runoff potential) when thoroughly wet. These consist mainly of deep, well drained to excessively drained sands or gravelly sands. These soils have a high rate of water transmission.
B	Soils having a moderate infiltration rate when thoroughly wet. These consist chiefly of moderately deep or deep, moderately well drained or well drained soils that have moderately fine texture to moderately coarse texture. These soils have a moderate rate of water transmission.
C	Soils having a slow infiltration rate when thoroughly wet. These consist chiefly of soils having a layer that impedes the downward movement of water or soils of moderately fine texture or fine texture. These soils have a slow rate of water transmission.
D	Soils having a very slow infiltration rate (high runoff potential) when thoroughly wet. These consist chiefly of clays that have a high shrink-swell potential, soils that have a high water table, soils that have a claypan or clay layer at or near the surface, and soils that are shallow over nearly impervious material. These soils have a very slow rate of water transmission.

The property is underlain by undocumented fill, surficial deposits such as topsoil, colluvium and alluvium, Terrace Deposits, and the Mission Valley Formation. Table 2 presents the information from the USDA website for the subject property.

**TABLE 2  
USDA WEB SOIL SURVEY – HYDROLOGIC SOIL GROUP**

Map Unit Name	Map Unit Symbol	Approximate Percentage of Property	Hydrologic Soil Group
Olivenhain cobbly loam, 9 to 30 percent slopes	OhE	5.0	D
Riverwash	Rm	18.5	D
Salinas clay loam, 0 to 2 percent slopes, warm MAAT, MLRA 19	SbA	76.6	C

## Infiltration Testing

We performed two borehole infiltration tests at the locations shown on Figure 1. The tests were performed in 8-inch-diameter, drilled borings. Table 3 presents the results of the testing. The calculation sheets are provided herein.

We used the guidelines presented in the Riverside County Low Impact Development BMP Design Handbook. Based on this widely accepted guideline, the saturated hydraulic conductivity (Ksat) is equivalent to the infiltration rate. Therefore, the Ksat value determined from our testing is assumed to be the unfactored infiltration rate.

**TABLE 3  
UNFACTORED, FIELD-SATURATED, INFILTRATION TEST RESULTS**

Test No.	Depth (inches)	Geologic Unit	Field Infiltration Rate, I (in/hr)	Factored* Field Infiltration Rate, I (in/hr)
A-1	68	Qt	0.004	0.002
A-2	92	Qt	0.082	0.041

\* Factor of Safety of 2.0 for feasibility determination.

## STORM WATER MANAGEMENT CONCLUSIONS

### Soil Types

**Undocumented Fill (Qpudf)** – We encountered undocumented fill up to 18 feet thick at the north end of the property. The undocumented fill within structural improvement areas will be removed and replaced with compacted fill. Water that is allowed to migrate into the undocumented fill or compacted fill will cause settlement. Therefore, full and partial infiltration should be considered infeasible within fill.

**Topsoil (Unmapped)** – We encountered topsoil varying between 0.5 and 3 feet thick across the site. Topsoil within structural improvement areas will be removed and replaced with compacted fill. Water that is allowed to migrate into the topsoil will cause settlement. Therefore, full and partial infiltration should be considered infeasible within topsoil.

**Colluvium (Qcol)** – We encountered colluvium on the north-facing slopes at the south property boundary, varying between 0.5 and 5 feet thick. Colluvium within structural improvement areas will be removed and replaced with compacted fill. Water that is allowed to migrate into colluvium will cause settlement. Therefore, full and partial infiltration should be considered infeasible within areas underlain by colluvium.

**Alluvium (Qal)** – Alluvium is present in a drainage located at the southeast corner of the property. Alluvium was also encountered in Trench T-20 beneath undocumented fill at the north end of the site. Alluvium within structural improvement areas will be removed and replaced with compacted fill. Water that is allowed to migrate into alluvium will cause settlement. Therefore, full and partial infiltration should be considered infeasible within areas underlain by alluvium.

**Terrace Deposits (Qt)** – We encountered Terrace Deposits underlying most of the site below the artificial fill, topsoil, and alluvium. The Terrace Deposits are comprised of very dense, clayey, conglomerate. Infiltration into the Terrace Deposits is not feasible due to its low infiltration characteristics.

**Mission Valley Formation (Tmv)** – We encountered age Mission Valley in slopes along the southern portion of the site. Mission Valley Formation may also be present underlying the Terrace Deposits in the central portion of the site. Infiltration into the Mission Valley Formation is not feasible due to low infiltration characteristics.

### **Groundwater Elevation**

Groundwater was not encountered in our borings or trenches to a depth explored. Infiltration should not impact groundwater.

### **Existing Utilities**

Existing utilities are located on the north side of the property and along the west and east property margins. Infiltration near these utilities is considered infeasible. Otherwise, infiltration due to utility concerns would be feasible.

### **Soil or Groundwater Contamination**

We are unaware of contaminated soil or groundwater on the property. Therefore, full and partial infiltration associated with this risk is considered feasible.

### **Slopes**

There are no existing slopes that would be impacted by infiltration. There are proposed fill slopes where infiltration adjacent to the slopes is not feasible.

### **Infiltration Rates**

Our test results indicated slow infiltration rates. The factored rates were 0.002 and 0.082 inches per hour. The infiltration rates are not high enough to support full or partial infiltration.



## Storm Water Management Devices

Liners should be incorporated in the proposed basin. The liner should be impermeable (e.g. High-density polyethylene, HDPE, with a thickness of about 30 mil or equivalent Polyvinyl Chloride, PVC). Penetration of the liners should be properly sealed. The devices should also be installed in accordance with the manufacturer’s recommendations. Overflow protection devices should also be incorporated into the design and construction of the storm water management device.

## Storm Water Standard Worksheets

The SWS requests the geotechnical engineer complete the *Categorization of Infiltration Feasibility Condition* (Worksheet C.4-1) worksheet information to help evaluate the potential for infiltration on the property. The attached Worksheet C.4-1 presents the completed information for the submittal process.

The regional storm water standards also have a worksheet (Worksheet Form D.5-1) that helps the project civil engineer estimate the factor of safety based on several factors. Table 4 describes the suitability assessment input parameters related to the geotechnical engineering aspects for the factor of safety determination.

**TABLE 4  
SUITABILITY ASSESSMENT RELATED CONSIDERATIONS FOR INFILTRATION FACILITY  
SAFETY FACTORS**

Consideration	High Concern – 3 Points	Medium Concern – 2 Points	Low Concern – 1 Point
Assessment Methods	Use of soil survey maps or simple texture analysis to estimate short-term infiltration rates. Use of well permeameter or borehole methods without accompanying continuous boring log. Relatively sparse testing with direct infiltration methods	Use of well permeameter or borehole methods with accompanying continuous boring log. Direct measurement of infiltration area with localized infiltration measurement methods (e.g., Infiltrometer). Moderate spatial resolution	Direct measurement with localized (i.e. small-scale) infiltration testing methods at relatively high resolution or use of extensive test pit infiltration measurement methods.
Predominant Soil Texture	Silty and clayey soils with significant fines	Loamy soils	Granular to slightly loamy soils
Site Soil Variability	Highly variable soils indicated from site assessment or unknown variability	Soil boring/test pits indicate moderately homogenous soils	Soil boring/test pits indicate relatively homogenous soils
Depth to Groundwater/ Impervious Layer	<5 feet below facility bottom	5-15 feet below facility bottom	>15 feet below facility bottom

Table 5 presents the estimated factor values for the evaluation of the factor of safety. This table only presents the suitability assessment safety factor (Part A) of the worksheet. The project civil engineer should evaluate the safety factor for design (Part B) and use the combined safety factor for the design infiltration rate.

**TABLE 5  
FACTOR OF SAFETY WORKSHEET D.5-1 DESIGN VALUES<sup>1</sup>**

Suitability Assessment Factor Category	Assigned Weight (w)	Factor Value (v)	Product (p = w x v)
Assessment Methods	0.25	2	0.50
Predominant Soil Texture	0.25	3	0.75
Site Soil Variability	0.25	2	0.50
Depth to Groundwater/Impervious Layer	0.25	1	0.25
Suitability Assessment Safety Factor, $S_A = \Sigma p$			2.0

<sup>1</sup> The project civil engineer should complete Worksheet D.5-1 using the data on this table. Additional information is required to evaluate the design factor of safety.

### CONCLUSIONS

Our results indicate the site has relatively slow infiltration characteristics and should be considered as having a “no infiltration” condition. Because of the site conditions, it is our opinion that there is a potential for lateral water migration if infiltration were to be allowed. Undocumented and previously placed fill exists on the property and has a high potential for adverse settlement when wetted. It is our opinion that full or partial infiltration is infeasible on this site. Our evaluation included the soil and geologic conditions, estimated settlement and volume change of the underlying soil, slope stability, utility considerations, groundwater mounding, retaining walls, foundations and existing groundwater elevations.

If there are any questions regarding this correspondence, or if we may be of further service, please contact the undersigned at your convenience.

Very truly yours,

GEOCON INCORPORATED

Rodney C. Mikesell  
GE 2533

RCM:arm

(e-mail) Addressee



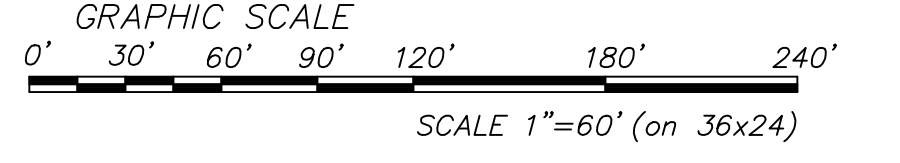
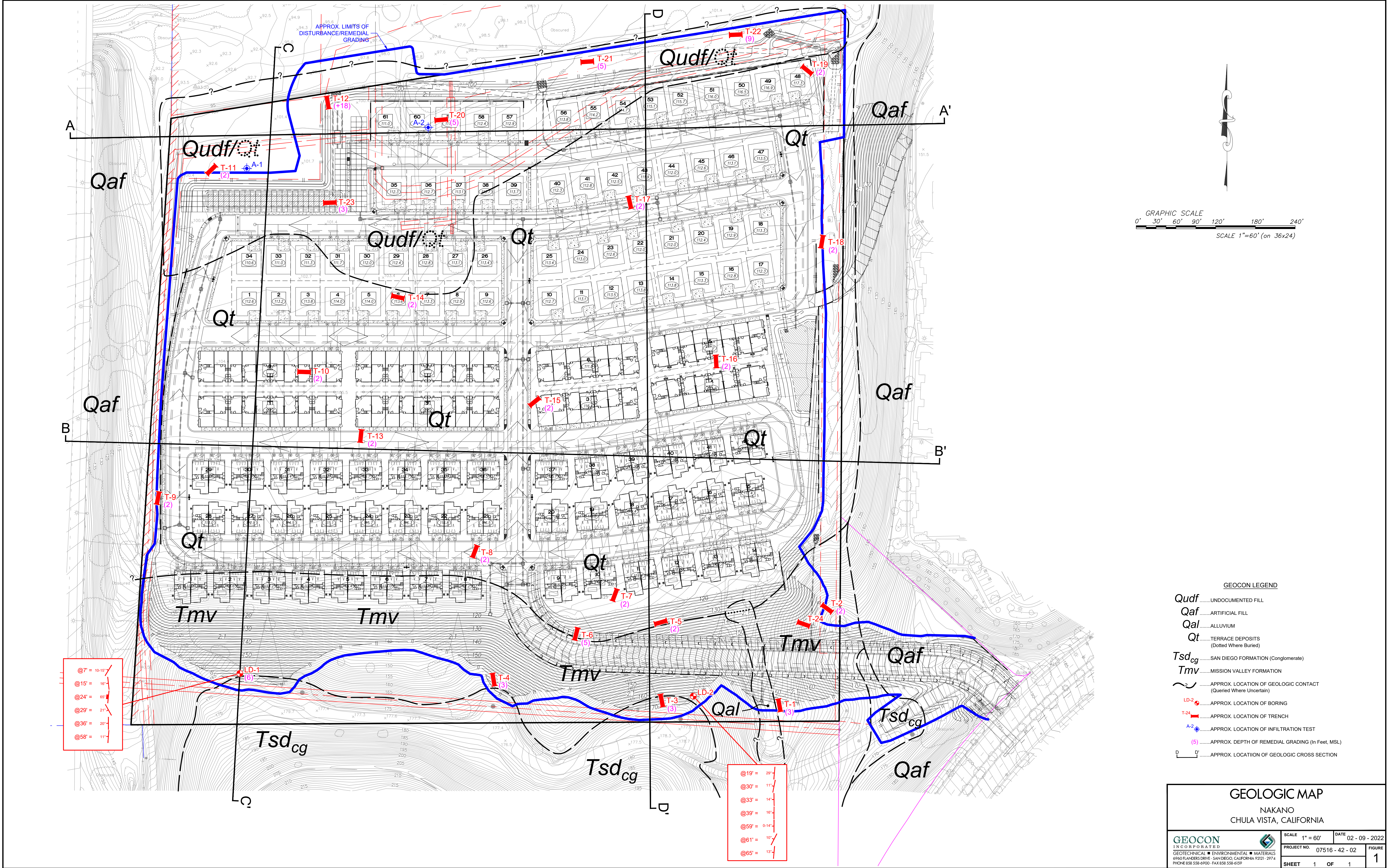

- GEOCON LEGEND**
- Qudf ..... UNDOCUMENTED FILL
  - Qaf ..... ARTIFICIAL FILL
  - Qal ..... ALLUVIUM
  - Qt ..... TERRACE DEPOSITS  
(Dotted Where Buried)
  - Tsd<sub>cg</sub> ..... SAN DIEGO FORMATION (Conglomerate)
  - Tmv ..... MISSION VALLEY FORMATION
  - ~ ..... APPROX. LOCATION OF GEOLOGIC CONTACT  
(Queried Where Uncertain)
  - LD-2 ..... APPROX. LOCATION OF BORING
  - T-24 ..... APPROX. LOCATION OF TRENCH
  - A-2 ..... APPROX. LOCATION OF INFILTRATION TEST
  - (5) ..... APPROX. DEPTH OF REMEDIAL GRADING (in Feet, MSL)
  - C-C' ..... APPROX. LOCATION OF GEOLOGIC CROSS SECTION

- @7' = 10-15'
- @15' = 16'
- @24' = 65'
- @29' = 21'
- @36' = 20'
- @58' = 11'

- @19' = 29'
- @30' = 11'
- @33' = 14'
- @39' = 16'
- @59' = 0-14'
- @61' = 10'
- @65' = 13'

**GEOLOGIC MAP**  
NAKANO  
CHULA VISTA, CALIFORNIA

<p><b>GEOCON</b> INCORPORATED</p> <p>GEOTECHNICAL ■ ENVIRONMENTAL ■ MATERIALS 6940 ANDERS DRIVE ■ SAN DIEGO, CALIFORNIA 92121-2974 PHONE 858.558.4900 ■ FAX 858.558.6159</p>	SCALE 1" = 60'	DATE 02 - 09 - 2022	
	PROJECT NO. 07516 - 42 - 02		FIGURE 1
	SHEET 1 OF 1		

Printed 02/09/2022 7:48AM | By: ALVIN LADRELLON | File Location: W:\1\_GEO\TECH\075000\07516-42-02\0202-02-09\07516-42-02\_Geo Map 30.dwg



### Aardvark Permeameter Data Analysis

Project Name: Nakano  
 Project Number: 07516-42-02  
 Test Number: A-1

Date: 12/20/2019  
 By: BRK

Borehole Diameter, d (in.): 8.00  
 Borehole Depth, H (in.): 68.00  
 Distance Between Reservoir & Top of Borehole (in.): 26.00  
 Height APM Raised from Bottom (in.): 2.00  
 Pressure Reducer Used: No

Ref. EL (feet, MSL): 102.0  
 Bottom EL (feet, MSL): 96.3

Distance Between Reservoir and APM Float, D (in.): 84.75  
 Head Height Measured, h (in.): 5.50

Reading	Time Elapsed (min)	Water Weight Consummed (lbs)	Water Volume Consummed (in <sup>3</sup> )	Q (in <sup>3</sup> /min)
1	0.00	0.000	0.00	0.00
2	5.00	11.530	319.29	63.858
3	5.00	1.665	46.11	9.222
4	5.00	0.155	4.29	0.858
5	5.00	0.045	1.25	0.249
6	5.00	0.045	1.25	0.249
7	5.00	0.035	0.97	0.194
8	5.00	0.035	0.97	0.194
9	10.00	0.045	1.25	0.125
10	10.00	0.045	1.25	0.125
11	10.00	0.030	0.83	0.083
12	10.00	0.025	0.69	0.069
13	10.00	0.020	0.55	0.055
14	10.00	0.015	0.42	0.042
15	10.00	0.015	0.42	0.042

Steady Flow Rate, Q (in<sup>3</sup>/min): 0.046

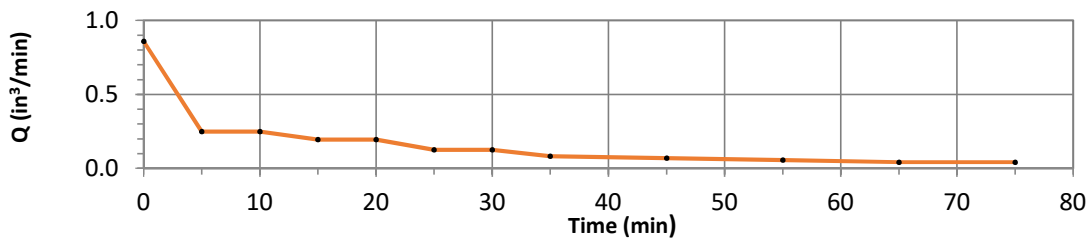

#### Soil Matric Flux Potential, $\phi_m$

$\phi_m =$  0.00060 in<sup>2</sup>/min

#### Field-Saturated Hydraulic Conductivity (Infiltration Rate)

$K_{sat} =$  6.07E-05 in/min      0.004 in/hr



**Borehole Infiltration Test**

Project Name: Nakano  
 Project Number: 07516-42-02  
 Test Number: A-2

Date: 12/20/2019  
 By: BRK  
 Ref. EL (feet, MSL): 100.0  
 Bottom EL (feet, MSL): 92.3

Borehole Diameter, d (in.): 8.00  
 Borehole Depth, H (in.): 92.00  
 Distance Between Reservoir & Top of Borehole (in.): 26.00  
 Height APM Raised from Bottom (in.): 2.00  
 Pressure Reducer Used: No

Distance Between Reservoir and APM Float, D (in.): 108.75  
 Head Height Measured, h (in.): 4.75

Reading	Time Elapsed (min)	Water Weight Consummed (lbs)	Water Volume Consummed (in <sup>3</sup> )	Q (in <sup>3</sup> /min)
1	0.00	0.000	0.00	0.00
2	5.00	11.255	311.68	62.335
3	5.00	1.095	30.32	6.065
4	5.00	0.315	8.72	1.745
5	5.00	0.995	27.55	5.511
6	5.00	1.075	29.77	5.954
7	5.00	0.985	27.28	5.455
8	5.00	0.915	25.34	5.068
9	5.00	0.890	24.65	4.929
10	5.00	0.845	23.40	4.680
11	5.00	0.770	21.32	4.265
12	5.00	0.740	20.49	4.098
13	5.00	0.695	19.25	3.849
14	5.00	0.665	18.42	3.683
15	5.00	0.655	18.14	3.628
16	6.00	0.750	20.77	3.462
17	4.00	0.440	12.18	3.046
18	5.00	0.565	15.65	3.129
19	5.00	0.535	14.82	2.963
20	5.00	0.530	14.68	2.935
21	5.00	0.510	14.12	2.825
22	6.00	0.610	16.89	2.815
23	4.00	0.405	11.22	2.804
Steady Flow Rate, Q (in <sup>3</sup> /min):				2.815

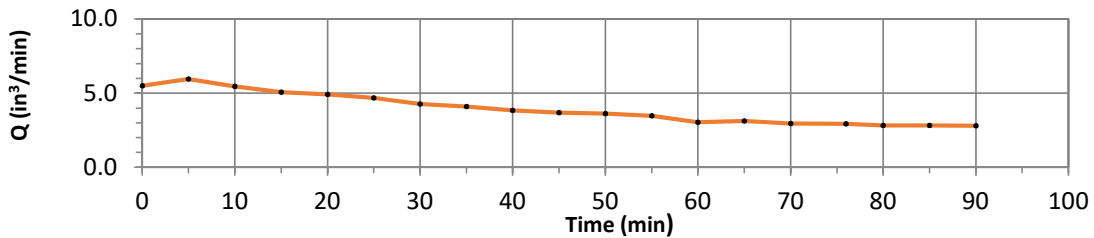

**Soil Matric Flux Potential,  $\phi_m$**

$\phi_m =$  0.0538 in<sup>2</sup>/min

**Field-Saturated Hydraulic Conductivity (Infiltration Rate)**

$K_{sat} =$  1.37E-03 in/min      0.082 in/hr

## Appendix C: Geotechnical and Groundwater Investigation Requirements

**Worksheet C.4-1: Categorization of Infiltration Feasibility Condition Based on Geotechnical Conditions<sup>9</sup>**

Categorization of Infiltration Feasibility Condition based on Geotechnical Conditions	Worksheet C.4-1: Form I-8A <sup>10</sup>
<b>Part 1 - Full Infiltration Feasibility Screening Criteria</b>	
<b>DMA(s) Being Analyzed:</b>	<b>Project Phase:</b>
Entire Site	Design
<b>Criteria 1: Infiltration Rate Screening</b>	
1A	<p>Is the mapped hydrologic soil group according to the NRCS Web Soil Survey or UC Davis Soil Web Mapper Type A or B and corroborated by available site soil data<sup>11</sup>?</p> <p><input type="checkbox"/> Yes; the DMA may feasibly support full infiltration. Answer “Yes” to Criteria 1 Result or continue to Step 1B if the applicant elects to perform infiltration testing.</p> <p><input type="checkbox"/> No; the mapped soil types are A or B but is not corroborated by available site soil data (continue to Step 1B).</p> <p><input checked="" type="checkbox"/> No; the mapped soil types are C, D, or “urban/unclassified” and is corroborated by available site soil data. Answer “No” to Criteria 1 Result.</p> <p><input type="checkbox"/> No; the mapped soil types are C, D, or “urban/unclassified” but is not corroborated by available site soil data (continue to Step 1B).</p>
1B	<p>Is the reliable infiltration rate calculated using planning phase methods from Table D.3-1?</p> <p><input type="checkbox"/> Yes; Continue to Step 1C.</p> <p><input type="checkbox"/> No; Skip to Step 1D.</p>
1C	<p>Is the reliable infiltration rate calculated using planning phase methods from Table D.3-1 greater than 0.5 inches per hour?</p> <p><input type="checkbox"/> Yes; the DMA may feasibly support full infiltration. Answer “Yes” to Criteria 1 Result.</p> <p><input type="checkbox"/> No; full infiltration is not required. Answer “No” to Criteria 1 Result.</p>
1D	<p><b>Infiltration Testing Method.</b> Is the selected infiltration testing method suitable during the design phase (see Appendix D.3)? Note: Alternative testing standards may be allowed with appropriate rationales and documentation.</p> <p><input type="checkbox"/> Yes; continue to Step 1E.</p> <p><input type="checkbox"/> No; select an appropriate infiltration testing method.</p>

<sup>9</sup> Note that it is not required to investigate each and every criterion in the worksheet, a single “no” answer in Part 1, Part 2, Part 3, or Part 4 determines a full, partial, or no infiltration condition.

<sup>10</sup> This form must be completed each time there is a change to the site layout that would affect the infiltration feasibility condition. Previously completed forms shall be retained to document the evolution of the site stormwater design.

<sup>11</sup> Available data includes site-specific sampling or observation of soil types or texture classes, such as obtained from borings or test pits necessary to support other design elements.



## Appendix C: Geotechnical and Groundwater Investigation Requirements

Categorization of Infiltration Feasibility Condition based on Geotechnical Conditions	Worksheet C.4-1: Form I-8A <sup>10</sup>
1E	<p><b>Number of Percolation/Infiltration Tests.</b> Does the infiltration testing method performed satisfy the minimum number of tests specified in Table D.3-2?</p> <p><input type="checkbox"/> Yes; continue to Step 1F.</p> <p><input type="checkbox"/> No; conduct appropriate number of tests.</p>
1F	<p><b>Factor of Safety.</b> Is the suitable Factor of Safety selected for full infiltration design? See guidance in D.5; Tables D.5-1 and D.5-2; and Worksheet D.5-1 (Form I-9).</p> <p><input type="checkbox"/> Yes; continue to Step 1G.</p> <p><input type="checkbox"/> No; select appropriate factor of safety.</p>
1G	<p><b>Full Infiltration Feasibility.</b> Is the average measured infiltration rate divided by the Factor of Safety greater than 0.5 inches per hour?</p> <p><input type="checkbox"/> Yes; answer “Yes” to Criteria 1 Result.</p> <p><input type="checkbox"/> No; answer “No” to Criteria 1 Result.</p>
Criteria 1 Result	<p>Is the estimated reliable infiltration rate greater than 0.5 inches per hour within the DMA where runoff can reasonably be routed to a BMP?</p> <p><input type="checkbox"/> Yes; the DMA may feasibly support full infiltration. Continue to Criteria 2.</p> <p><input checked="" type="checkbox"/> No; full infiltration is not required. Skip to Part 1 Result.</p>
<p>We performed two borehole infiltration tests in the area of the proposed basin. The test results are summarized below. The rates are not high enough to support full or partial infiltration.</p> <p>A-1: 0.004 in/hr (0.002 in/hr using a factor of 2 for feasibility determination)</p> <p>A-2: 0.082 in/hr (0.041 in/hr using a factor of 2 for feasibility determination)</p>	



## Appendix C: Geotechnical and Groundwater Investigation Requirements

Categorization of Infiltration Feasibility Condition based on Geotechnical Conditions		Worksheet C.4-1: Form I-8A <sup>10</sup>	
<b>Criteria 2: Geologic/Geotechnical Screening</b>			
2A	<p>If all questions in Step 2A are answered “Yes,” continue to Step 2B.</p> <p>For any “No” answer in Step 2A answer “No” to Criteria 2, and submit an “Infiltration Feasibility Condition Letter” that meets the requirements in Appendix C.1.1. The geologic/geotechnical analyses listed in Appendix C.2.1 do not apply to the DMA because one of the following setbacks cannot be avoided and therefore result in the DMA being in a no infiltration condition. The setbacks must be the closest horizontal radial distance from the surface edge (at the overflow elevation) of the BMP.</p>		
2A-1	Can the proposed full infiltration BMP(s) avoid areas with existing fill materials greater than 5 feet thick below the infiltrating surface?	<input type="checkbox"/> Yes	<input type="checkbox"/> No
2A-2	Can the proposed full infiltration BMP(s) avoid placement within 10 feet of existing underground utilities, structures, or retaining walls?	<input type="checkbox"/> Yes	<input type="checkbox"/> No
2A-3	Can the proposed full infiltration BMP(s) avoid placement within 50 feet of a natural slope (>25%) or within a distance of 1.5H from fill slopes where H is the height of the fill slope?	<input type="checkbox"/> Yes	<input type="checkbox"/> No
2B	<p>When full infiltration is determined to be feasible, a geotechnical investigation report must be prepared that considers the relevant factors identified in Appendix C.2.1.</p> <p>If all questions in Step 2B are answered “Yes,” then answer “Yes” to Criteria 2 Result. If there are “No” answers continue to Step 2C.</p>		
2B-1	<p><b>Hydroconsolidation.</b> Analyze hydroconsolidation potential per approved ASTM standard due to a proposed full infiltration BMP.</p> <p>Can full infiltration BMPs be proposed within the DMA without increasing hydroconsolidation risks?</p>	<input type="checkbox"/> Yes	<input type="checkbox"/> No
2B-2	<p><b>Expansive Soils.</b> Identify expansive soils (soils with an expansion index greater than 20) and the extent of such soils due to proposed full infiltration BMPs.</p> <p>Can full infiltration BMPs be proposed within the DMA without increasing expansive soil risks?</p>	<input type="checkbox"/> Yes	<input type="checkbox"/> No



## Appendix C: Geotechnical and Groundwater Investigation Requirements

Categorization of Infiltration Feasibility Condition based on Geotechnical Conditions		Worksheet C.4-1: Form I-8A <sup>10</sup>	
2B-3	<p><b>Liquefaction.</b> If applicable, identify mapped liquefaction areas. Evaluate liquefaction hazards in accordance with Section 6.4.2 of the City of San Diego's Guidelines for Geotechnical Reports (2011 or most recent edition). Liquefaction hazard assessment shall take into account any increase in groundwater elevation or groundwater mounding that could occur as a result of proposed infiltration or percolation facilities.</p> <p>Can full infiltration BMPs be proposed within the DMA without increasing liquefaction risks?</p>	<input type="checkbox"/> Yes	<input type="checkbox"/> No
2B-4	<p><b>Slope Stability.</b> If applicable, perform a slope stability analysis in accordance with the ASCE and Southern California Earthquake Center (2002) Recommended Procedures for Implementation of DMG Special Publication 117, Guidelines for Analyzing and Mitigating Landslide Hazards in California to determine minimum slope setbacks for full infiltration BMPs. See the City of San Diego's Guidelines for Geotechnical Reports (2011) to determine which type of slope stability analysis is required.</p> <p>Can full infiltration BMPs be proposed within the DMA without increasing slope stability risks?</p>	<input type="checkbox"/> Yes	<input type="checkbox"/> No
2B-5	<p><b>Other Geotechnical Hazards.</b> Identify site-specific geotechnical hazards not already mentioned (refer to Appendix C.2.1).</p> <p>Can full infiltration BMPs be proposed within the DMA without increasing risk of geologic or geotechnical hazards not already mentioned?</p>	<input type="checkbox"/> Yes	<input type="checkbox"/> No
2B-6	<p><b>Setbacks.</b> Establish setbacks from underground utilities, structures, and/or retaining walls. Reference applicable ASTM or other recognized standard in the geotechnical report.</p> <p>Can full infiltration BMPs be proposed within the DMA using established setbacks from underground utilities, structures, and/or retaining walls?</p>	<input type="checkbox"/> Yes	<input type="checkbox"/> No

## Appendix C: Geotechnical and Groundwater Investigation Requirements

Categorization of Infiltration Feasibility Condition based on Geotechnical Conditions		Worksheet C.4-1: Form I-8A <sup>10</sup>	
2C	<p><b>Mitigation Measures.</b> Propose mitigation measures for each geologic/geotechnical hazard identified in Step 2B. Provide a discussion of geologic/geotechnical hazards that would prevent full infiltration BMPs that cannot be reasonably mitigated in the geotechnical report. See Appendix C.2.1.8 for a list of typically reasonable and typically unreasonable mitigation measures.</p> <p>Can mitigation measures be proposed to allow for full infiltration BMPs? If the question in Step 2 is answered “Yes,” then answer “Yes” to Criteria 2 Result.</p> <p>If the question in Step 2C is answered “No,” then answer “No” to Criteria 2 Result.</p>	<input type="checkbox"/> Yes	<input type="checkbox"/> No
Criteria 2 Result	<p>Can infiltration greater than 0.5 inches per hour be allowed without increasing risk of geologic or geotechnical hazards that cannot be reasonably mitigated to an acceptable level?</p>	<input type="checkbox"/> Yes	<input type="checkbox"/> No
<p>Summarize findings and basis; provide references to related reports or exhibits.</p>			
<b>Part 1 Result – Full Infiltration Geotechnical Screening</b> <sup>12</sup>		<b>Result</b>	
<p>If answers to both Criteria 1 and Criteria 2 are “Yes”, a full infiltration design is potentially feasible based on Geotechnical conditions only.</p> <p>If either answer to Criteria 1 or Criteria 2 is “No”, a full infiltration design is not required.</p>		<input type="checkbox"/> Full infiltration Condition <input checked="" type="checkbox"/> Complete Part 2	

<sup>12</sup> To be completed using gathered site information and best professional judgement considering the definition of MEP in the MS4 Permit. Additional testing and/or studies may be required by City Engineer to substantiate findings.



**Appendix C: Geotechnical and Groundwater Investigation Requirements**

Categorization of Infiltration Feasibility Condition based on Geotechnical Conditions		Worksheet C.4-1: Form I-8A <sup>10</sup>
<b>Part 2 – Partial vs. No Infiltration Feasibility Screening Criteria</b>		
<b>DMA(s) Being Analyzed:</b>		<b>Project Phase:</b>
Entire Site		Design
<b>Criteria 3 : Infiltration Rate Screening</b>		
3A	<p><b>NRCS Type C, D, or “urban/unclassified”:</b> Is the mapped hydrologic soil group according to the NRCS Web Soil Survey or UC Davis Soil Web Mapper is Type C, D, or “urban/unclassified” and corroborated by available site soil data?</p> <p><input type="checkbox"/> Yes; the site is mapped as C soils and a reliable infiltration rate of 0.15 in/hr. is used to size partial infiltration BMPS. Answer “Yes” to Criteria 3 Result.</p> <p><input type="checkbox"/> Yes; the site is mapped as D soils or “urban/unclassified” and a reliable infiltration rate of 0.05 in/hr. is used to size partial infiltration BMPS. Answer “Yes” to Criteria 3 Result.</p> <p><input checked="" type="checkbox"/> No; infiltration testing is conducted (refer to Table D.3-1), continue to Step 3B.</p>	
3B	<p><b>Infiltration Testing Result:</b> Is the reliable infiltration rate (i.e. average measured infiltration rate/2) greater than 0.05 in/hr. and less than or equal to 0.5 in/hr?</p> <p><input type="checkbox"/> Yes; the site may support partial infiltration. Answer “Yes” to Criteria 3 Result.</p> <p><input checked="" type="checkbox"/> No; the reliable infiltration rate (i.e. average measured rate/2) is less than 0.05 in/hr., partial infiltration is not required. Answer “No” to Criteria 3 Result.</p>	
Criteria 3 Result	<p>Is the estimated reliable infiltration rate (i.e., average measured infiltration rate/2) greater than or equal to 0.05 inches/hour and less than or equal to 0.5 inches/hour at any location within each DMA where runoff can reasonably be routed to a BMP?</p> <p><input type="checkbox"/> Yes; Continue to Criteria 4.</p> <p><input checked="" type="checkbox"/> No; Skip to Part 2 Result.</p>	
<p>We performed two borehole infiltration tests in the area of the proposed basin. The test results are summarized below. The rates are not high enough to support full or partial infiltration.</p> <p>A-1: 0.004 in/hr (0.002 in/hr using a factor of 2 for feasibility determination)                      A-2: 0.082 in/hr (0.041 in/hr using a factor of 2 for feasibility determination)</p>		



## Appendix C: Geotechnical and Groundwater Investigation Requirements

Categorization of Infiltration Feasibility Condition based on Geotechnical Conditions		Worksheet C.4-1: Form I-8A <sup>10</sup>	
<b>Criteria 4: Geologic/Geotechnical Screening</b>			
4A	<p>If all questions in Step 4A are answered “Yes,” continue to Step 2B.</p> <p>For any “No” answer in Step 4A answer “No” to Criteria 4 Result, and submit an “Infiltration Feasibility Condition Letter” that meets the requirements in Appendix C.1.1. The geologic/geotechnical analyses listed in Appendix C.2.1 do not apply to the DMA because one of the following setbacks cannot be avoided and therefore result in the DMA being in a no infiltration condition. The setbacks must be the closest horizontal radial distance from the surface edge (at the overflow elevation) of the BMP.</p>		
4A-1	Can the proposed partial infiltration BMP(s) avoid areas with existing fill materials greater than 5 feet thick?	<input type="checkbox"/> Yes	<input type="checkbox"/> No
4A-2	Can the proposed partial infiltration BMP(s) avoid placement within 10 feet of existing underground utilities, structures, or retaining walls?	<input type="checkbox"/> Yes	<input type="checkbox"/> No
4A-3	Can the proposed partial infiltration BMP(s) avoid placement within 50 feet of a natural slope (>25%) or within a distance of 1.5H from fill slopes where H is the height of the fill slope?	<input type="checkbox"/> Yes	<input type="checkbox"/> No
4B	<p>When full infiltration is determined to be feasible, a geotechnical investigation report must be prepared that considers the relevant factors identified in Appendix C.2.1</p> <p>If all questions in Step 4B are answered “Yes,” then answer “Yes” to Criteria 4 Result. If there are any “No” answers continue to Step 4C.</p>		
4B-1	<p><b>Hydroconsolidation.</b> Analyze hydroconsolidation potential per approved ASTM standard due to a proposed full infiltration BMP.</p> <p>Can partial infiltration BMPs be proposed within the DMA without increasing hydroconsolidation risks?</p>	<input type="checkbox"/> Yes	<input type="checkbox"/> No
4B-2	<p><b>Expansive Soils.</b> Identify expansive soils (soils with an expansion index greater than 20) and the extent of such soils due to proposed full infiltration BMPs.</p> <p>Can partial infiltration BMPs be proposed within the DMA without increasing expansive soil risks?</p>	<input type="checkbox"/> Yes	<input type="checkbox"/> No
4B-3	<p><b>Liquefaction.</b> If applicable, identify mapped liquefaction areas. Evaluate liquefaction hazards in accordance with Section 6.4.2 of the City of San Diego's Guidelines for Geotechnical Reports (2011). Liquefaction hazard assessment shall take into account any increase in groundwater elevation or groundwater mounding that could occur as a result of proposed infiltration or percolation facilities.</p> <p>Can partial infiltration BMPs be proposed within the DMA without increasing liquefaction risks?</p>	<input type="checkbox"/> Yes	<input type="checkbox"/> No

## Appendix C: Geotechnical and Groundwater Investigation Requirements

Categorization of Infiltration Feasibility Condition based on Geotechnical Conditions		Worksheet C.4-1: Form I-8A <sup>10</sup>	
4B-4	<p><b>Slope Stability.</b> If applicable, perform a slope stability analysis in accordance with the ASCE and Southern California Earthquake Center (2002) Recommended Procedures for Implementation of DMG Special Publication 117, Guidelines for Analyzing and Mitigating Landslide Hazards in California to determine minimum slope setbacks for full infiltration BMPs. See the City of San Diego's Guidelines for Geotechnical Reports (2011) to determine which type of slope stability analysis is required.</p> <p>Can partial infiltration BMPs be proposed within the DMA without increasing slope stability risks?</p>	<input type="checkbox"/> Yes	<input type="checkbox"/> No
4B-5	<p><b>Other Geotechnical Hazards.</b> Identify site-specific geotechnical hazards not already mentioned (refer to Appendix C.2.1).</p> <p>Can partial infiltration BMPs be proposed within the DMA without increasing risk of geologic or geotechnical hazards not already mentioned?</p>	<input type="checkbox"/> Yes	<input type="checkbox"/> No
4B-6	<p><b>Setbacks.</b> Establish setbacks from underground utilities, structures, and/or retaining walls. Reference applicable ASTM or other recognized standard in the geotechnical report.</p> <p>Can partial infiltration BMPs be proposed within the DMA using recommended setbacks from underground utilities, structures, and/or retaining walls?</p>	<input type="checkbox"/> Yes	<input type="checkbox"/> No
4C	<p><b>Mitigation Measures.</b> Propose mitigation measures for each geologic/geotechnical hazard identified in Step 4B. Provide a discussion on geologic/geotechnical hazards that would prevent partial infiltration BMPs that cannot be reasonably mitigated in the geotechnical report. See Appendix C.2.1.8 for a list of typically reasonable and typically unreasonable mitigation measures.</p> <p>Can mitigation measures be proposed to allow for partial infiltration BMPs? If the question in Step 4C is answered "Yes," then answer "Yes" to Criteria 4 Result. If the question in Step 4C is answered "No," then answer "No" to Criteria 4 Result.</p>	<input type="checkbox"/> Yes	<input type="checkbox"/> No
Criteria 4 Result	<p>Can infiltration of greater than or equal to 0.05 inches/hour and less than or equal to 0.5 inches/hour be allowed without increasing the risk of geologic or geotechnical hazards that cannot be reasonably mitigated to an acceptable level?</p>	<input type="checkbox"/> Yes	<input type="checkbox"/> No

## Appendix C: Geotechnical and Groundwater Investigation Requirements

Categorization of Infiltration Feasibility Condition based on Geotechnical Conditions	Worksheet C.4-1: Form I-8A <sup>10</sup>
<p>Summarize findings and basis; provide references to related reports or exhibits.</p>	
Part 2 – Partial Infiltration Geotechnical Screening Result <sup>13</sup>	Result
<p>If answers to both Criteria 3 and Criteria 4 are “Yes”, a partial infiltration design is potentially feasible based on geotechnical conditions only.</p> <p>If answers to either Criteria 3 or Criteria 4 is “No”, then infiltration of any volume is considered to be infeasible within the site.</p>	<p><input type="checkbox"/> Partial Infiltration Condition</p> <p><input checked="" type="checkbox"/> No Infiltration Condition</p>

<sup>13</sup> To be completed using gathered site information and best professional judgement considering the definition of MEP in the MS4 Permit. Additional testing and/or studies may be required by City Engineer to substantiate findings.



**City of Chula Vista Infiltration Feasibility Letter**  
(For Review by City of Chula Vista)

## APPENDIX C

### STORM WATER MANAGEMENT

We understand storm water management devices are being proposed in accordance with the current Storm Water Standards (SWS). If not properly constructed, there is a potential for distress to improvements and properties located hydrologically down gradient or adjacent to these devices. Factors such as the amount of water to be detained, its residence time, and soil permeability have an important effect on seepage transmission and the potential adverse impacts that may occur if the storm water management features are not properly designed and constructed. We have not performed a hydrogeological study at the site. If infiltration of storm water runoff occurs, downstream properties and improvements may be subjected to seeps, springs, slope instability, raised groundwater, movement of foundations and slabs, or other undesirable impacts as a result of water infiltration.

#### Hydrologic Soil Group

The United States Department of Agriculture (USDA), Natural Resources Conservation Services, possesses general information regarding the existing soil conditions for areas within the United States. The USDA website also provides the Hydrologic Soil Group. Table C-1 presents the descriptions of the hydrologic soil groups. In addition, the USDA website also provides an estimated saturated hydraulic conductivity for the existing soil.

**TABLE C-1  
HYDROLOGIC SOIL GROUP DEFINITIONS**

Soil Group	Soil Group Definition
A	Soils having a high infiltration rate (low runoff potential) when thoroughly wet. These consist mainly of deep, well drained to excessively drained sands or gravelly sands. These soils have a high rate of water transmission.
B	Soils having a moderate infiltration rate when thoroughly wet. These consist chiefly of moderately deep or deep, moderately well drained or well drained soils that have moderately fine texture to moderately coarse texture. These soils have a moderate rate of water transmission.
C	Soils having a slow infiltration rate when thoroughly wet. These consist chiefly of soils having a layer that impedes the downward movement of water or soils of moderately fine texture or fine texture. These soils have a slow rate of water transmission.
D	Soils having a very slow infiltration rate (high runoff potential) when thoroughly wet. These consist chiefly of clays that have a high shrink-swell potential, soils that have a high water table, soils that have a claypan or clay layer at or near the surface, and soils that are shallow over nearly impervious material. These soils have a very slow rate of water transmission.



The property is underlain by undocumented fill, surficial deposits such as topsoil, colluvium and alluvium, Terrace Deposits, and the Mission Valley Formation. Table C-2 presents the information from the USDA website for the subject property.

**TABLE C-2  
USDA WEB SOIL SURVEY – HYDROLOGIC SOIL GROUP**

Map Unit Name	Map Unit Symbol	Approximate Percentage of Property	Hydrologic Soil Group
Olivenhain cobbly loam, 9 to 30 percent slopes	OhE	5.0	D
Riverwash	Rm	18.5	D
Salinas clay loam, 0 to 2 percent slopes, warm MAAT, MLRA 19	SbA	76.6	C

### Infiltration Testing

We performed two borehole infiltration tests at the locations shown on Figure 2. The tests were performed in 8-inch-diameter, drilled borings. Table C-3 presents the results of the testing. The calculation sheets are provided herein.

We used the guidelines presented in the Riverside County Low Impact Development BMP Design Handbook. Based on this widely accepted guideline, the saturated hydraulic conductivity (Ksat) is equivalent to the infiltration rate. Therefore, the Ksat value determined from our testing is assumed to be the unfactored infiltration rate.

**TABLE C-3  
UNFACTORED, FIELD-SATURATED, INFILTRATION TEST RESULTS**

Test No.	Depth (inches)	Geologic Unit	Field Infiltration Rate, I (in/hr)	Factored* Field Infiltration Rate, I (in/hr)
A-1	68	Qudf	0.004	0.002
A-2	92	Qudf	0.244	0.12

\* Factor of Safety of 2.0 for feasibility determination.

## STORM WATER MANAGEMENT CONCLUSIONS

### Soil Types

**Undocumented Fill (Qpudf)** – We encountered undocumented fill up to 18 feet thick at the north end of the property. The undocumented fill within structural improvement areas will be removed and replaced with compacted fill. Water that is allowed to migrate into the undocumented fill or

compacted fill will cause settlement. Therefore, full and partial infiltration should be considered infeasible within fill.

**Topsoil (Unmapped)** – We encountered topsoil varying between 0.5 and 3 feet thick across the site. Topsoil within structural improvement areas will be removed and replaced with compacted fill. Water that is allowed to migrate into the topsoil will cause settlement. Therefore, full and partial infiltration should be considered infeasible within topsoil.

**Colluvium (Qcol)** – We encountered colluvium on the north-facing slopes at the south property boundary, varying between 0.5 and 5 feet thick. Colluvium within structural improvement areas will be removed and replaced with compacted fill. Water that is allowed to migrate into colluvium will cause settlement. Therefore, full and partial infiltration should be considered infeasible within areas underlain by colluvium.

**Alluvium (Qal)** – Alluvium is present in a drainage located at the southeast corner of the property. Alluvium was also encountered in Trench T-20 beneath undocumented fill at the north end of the site. Alluvium within structural improvement areas will be removed and replaced with compacted fill. Water that is allowed to migrate into alluvium will cause settlement. Therefore, full and partial infiltration should be considered infeasible within areas underlain by alluvium.

**Terrace Deposits (Qt)** – We encountered Terrace Deposits underlying most of the site below the artificial fill, topsoil, and alluvium. Infiltration into Terrace Deposits may be possible.

**Mission Valley Formation (Tmv)** – We encountered age Mission Valley in slopes along the southern portion of the site. Mission Valley Formation may also be present underlying the Terrace Deposits in the central portion of the site. Infiltration into the Mission Valley Formation is not feasible due to low infiltration characteristics.

## Groundwater Elevation

Groundwater was not encountered in our borings or trenches to a depths explored. Infiltration should not impact groundwater.

## Existing Utilities

Existing utilities are located on the north side of the property and along the west and east property margins. Infiltration near these utilities is considered infeasible. Otherwise, infiltration due to utility concerns would be feasible.

## Soil or Groundwater Contamination

We are unaware of contaminated soil or groundwater on the property. Therefore, full and partial infiltration associated with this risk is considered feasible.

## Slopes

There are no existing slopes that would be impacted by infiltration. There are proposed fill slopes where infiltration adjacent to the slopes is not feasible.

## Infiltration Rates

Our test results indicated slow infiltration rates. The factored rates were 0.002 and 0.12 inches per hour. The infiltration rates are not high enough to support full or partial infiltration in the area of the proposed BMP.

## Storm Water Management Devices

Liners should be incorporated in the proposed basin. The liner should be impermeable (e.g. High-density polyethylene, HDPE, with a thickness of about 30 mil or equivalent Polyvinyl Chloride, PVC). Penetration of the liners should be properly sealed. The devices should also be installed in accordance with the manufacturer's recommendations. Overflow protection devices should also be incorporated into the design and construction of the storm water management device.

## Storm Water Standard Worksheets

The SWS requests the geotechnical engineer complete the *Categorization of Infiltration Feasibility Condition* (Worksheet C.4-1) worksheet information to help evaluate the potential for infiltration on the property. The attached Worksheet C.4-1 presents the completed information for the submittal process.

The regional storm water standards also have a worksheet (Worksheet Form D.5-1) that helps the project civil engineer estimate the factor of safety based on several factors. Table C-4 describes the suitability assessment input parameters related to the geotechnical engineering aspects for the factor of safety determination.

**TABLE C-4**  
**SUITABILITY ASSESSMENT RELATED CONSIDERATIONS FOR INFILTRATION FACILITY**  
**SAFETY FACTORS**

Consideration	High Concern – 3 Points	Medium Concern – 2 Points	Low Concern – 1 Point
Assessment Methods	Use of soil survey maps or simple texture analysis to estimate short-term infiltration rates. Use of well permeameter or borehole methods without accompanying continuous boring log. Relatively sparse testing with direct infiltration methods	Use of well permeameter or borehole methods with accompanying continuous boring log. Direct measurement of infiltration area with localized infiltration measurement methods (e.g., Infiltrometer). Moderate spatial resolution	Direct measurement with localized (i.e. small-scale) infiltration testing methods at relatively high resolution or use of extensive test pit infiltration measurement methods.
Predominant Soil Texture	Silty and clayey soils with significant fines	Loamy soils	Granular to slightly loamy soils
Site Soil Variability	Highly variable soils indicated from site assessment or unknown variability	Soil boring/test pits indicate moderately homogenous soils	Soil boring/test pits indicate relatively homogenous soils
Depth to Groundwater/ Impervious Layer	<5 feet below facility bottom	5-15 feet below facility bottom	>15 feet below facility bottom

Table C-5 presents the estimated factor values for the evaluation of the factor of safety. This table only presents the suitability assessment safety factor (Part A) of the worksheet. The project civil engineer should evaluate the safety factor for design (Part B) and use the combined safety factor for the design infiltration rate.

**TABLE C-5**  
**FACTOR OF SAFETY WORKSHEET D.5-1 DESIGN VALUES<sup>1</sup>**

Suitability Assessment Factor Category	Assigned Weight (w)	Factor Value (v)	Product (p = w x v)
Assessment Methods	0.25	2	0.50
Predominant Soil Texture	0.25	3	0.75
Site Soil Variability	0.25	2	0.50
Depth to Groundwater/Impervious Layer	0.25	1	0.25
Suitability Assessment Safety Factor, $S_A = \Sigma p$			2.0

<sup>1</sup> The project civil engineer should complete Worksheet D.5-1 using the data on this table. Additional information is required to evaluate the design factor of safety.

## CONCLUSIONS

Our results indicate the site has relatively slow infiltration characteristics. Because of the site conditions, it is our opinion that there is a potential for lateral water migration. Undocumented and previously placed fill exists on the property and has a high potential for adverse settlement when wetted. It is our opinion that full or partial infiltration is infeasible on this site. Our evaluation included the soil and geologic conditions, estimated settlement and volume change of the underlying soil, slope stability, utility considerations, groundwater mounding, retaining walls, foundations and existing groundwater elevations.



### Aardvark Permeameter Data Analysis

Project Name: Nakano  
 Project Number: 07516-42-02  
 Test Number: A-1

Date: 12/20/2019  
 By: BRK

Borehole Diameter, d (in.): 8.00  
 Borehole Depth, H (in.): 68.00  
 Distance Between Reservoir & Top of Borehole (in.): 26.00  
 Height APM Raised from Bottom (in.): 2.00  
 Pressure Reducer Used: No

Ref. EL (feet, MSL): 102.0  
 Bottom EL (feet, MSL): 96.3

Distance Between Reservoir and APM Float, D (in.): 84.75  
 Head Height Measured, h (in.): 5.50

Reading	Time Elapsed (min)	Water Weight Consummed (lbs)	Water Volume Consummed (in <sup>3</sup> )	Q (in <sup>3</sup> /min)
1	0.00	0.000	0.00	0.00
2	5.00	11.530	319.29	63.858
3	5.00	1.665	46.11	9.222
4	5.00	0.155	4.29	0.858
5	5.00	0.045	1.25	0.249
6	5.00	0.045	1.25	0.249
7	5.00	0.035	0.97	0.194
8	5.00	0.035	0.97	0.194
9	10.00	0.045	1.25	0.125
10	10.00	0.045	1.25	0.125
11	10.00	0.030	0.83	0.083
12	10.00	0.025	0.69	0.069
13	10.00	0.020	0.55	0.055
14	10.00	0.015	0.42	0.042
15	10.00	0.015	0.42	0.042
Steady Flow Rate, Q (in <sup>3</sup> /min):				0.046

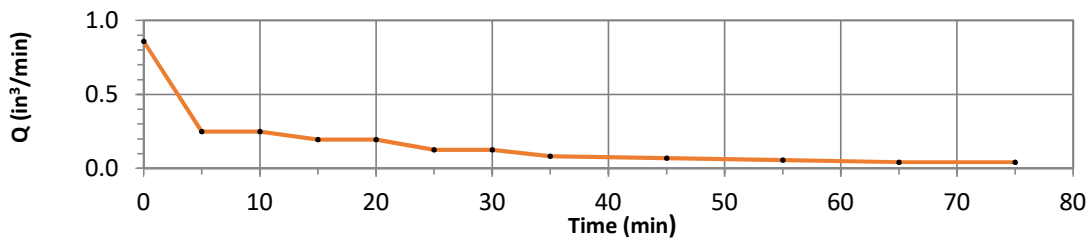

**Soil Matric Flux Potential,  $\phi_m$**

$\phi_m =$  0.00060 in<sup>2</sup>/min

**Field-Saturated Hydraulic Conductivity (Infiltration Rate)**

$K_{sat} =$  6.07E-05 in/min      0.004 in/hr



### Borehole Infiltration Test

Project Name: Nakano  
 Project Number: 07516-42-02  
 Test Number: A-2

Date: 12/20/2019  
 By: BRK  
 Ref. EL (feet, MSL): 100.0  
 Bottom EL (feet, MSL): 92.3

Borehole Diameter, d (in.): 8.00  
 Borehole Depth, H (in.): 92.00  
 Distance Between Reservoir & Top of Borehole (in.): 26.00  
 Height APM Raised from Bottom (in.): 2.00  
 Pressure Reducer Used: No

Distance Between Reservoir and APM Float, D (in.): 108.75  
 Head Height Measured, h (in.): 4.75

Reading	Time Elapsed (min)	Water Weight Consummed (lbs)	Water Volume Consummed (in <sup>3</sup> )	Q (in <sup>3</sup> /min)
1	0.00	0.000	0.00	0.00
2	5.00	11.255	311.68	62.335
3	5.00	1.095	30.32	6.065
4	5.00	0.315	8.72	1.745
5	5.00	0.995	27.55	5.511
6	5.00	1.075	29.77	5.954
7	5.00	0.985	27.28	5.455
8	5.00	0.915	25.34	5.068
9	5.00	0.890	24.65	4.929
10	5.00	0.845	23.40	4.680
11	5.00	0.770	21.32	4.265
12	5.00	0.740	20.49	4.098
13	5.00	0.695	19.25	3.849
14	5.00	0.665	18.42	3.683
15	5.00	0.655	18.14	3.628
16	6.00	0.750	20.77	3.462
17	4.00	0.440	12.18	3.046
18	5.00	0.565	15.65	3.129
19	5.00	0.535	14.82	2.963
20	5.00	0.530	14.68	2.935
21	5.00	0.510	14.12	2.825
22	6.00	0.610	16.89	2.815
23	4.00	0.405	11.22	2.804
Steady Flow Rate, Q (in <sup>3</sup> /min):				2.815

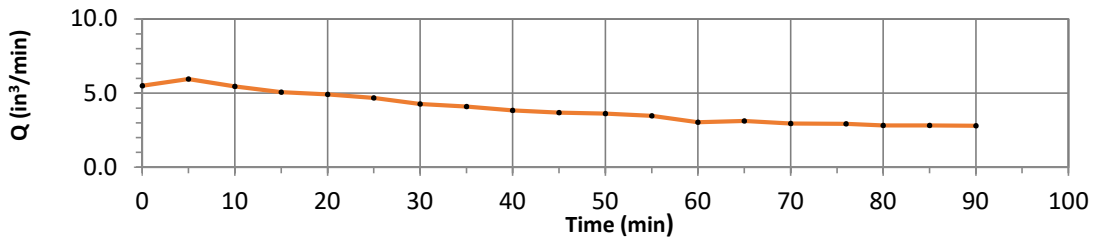

**Soil Matric Flux Potential,  $\phi_m$**

$\phi_m =$  0.0538 in<sup>2</sup>/min

**Field-Saturated Hydraulic Conductivity (Infiltration Rate)**

$K_{sat} =$  1.37E-03 in/min      0.082 in/hr

Project Name: \_\_\_\_\_

Categorization of Infiltration Feasibility Condition based on Geotechnical Conditions		Form I-8A <sup>1</sup> (Worksheet C.4-1)
<b>Part 1 - Full Infiltration Feasibility Screening Criteria</b>		
<b>DMA(s) Being Analyzed:</b>		<b>Project Phase:</b>
Entire Site		Planning
<b>Criteria 1: Infiltration Rate Screening</b>		
<b>1A</b>	<p>Is the mapped hydrologic soil group according to the NRCS Web Soil Survey or UC Davis Soil Web Mapper Type A or B and corroborated by available site soil data<sup>2</sup>?</p> <p><input type="checkbox"/> Yes; the DMA may feasibly support full infiltration. Answer “Yes” to Criteria 1 Result or continue to Step 1B if the applicant elects to perform infiltration testing.</p> <p><input type="checkbox"/> No; the mapped soil types are A or B but is not corroborated by available site soil data (continue to Step 1B).</p> <p><input checked="" type="checkbox"/> No; the mapped soil types are C, D, or “urban/unclassified” and is corroborated by available site soil data. Answer “No” to Criteria 1 Result.</p> <p><input type="checkbox"/> No; the mapped soil types are C, D, or “urban/unclassified” but is not corroborated by available site soil data (continue to Step 1B).</p>	
<b>1B</b>	<p>Is the reliable infiltration rate calculated using planning phase methods from Table D.3-1?</p> <p><input checked="" type="checkbox"/> Yes; Continue to Step 1C.</p> <p><input type="checkbox"/> No; Skip to Step 1D.</p>	
<b>1C</b>	<p>Is the reliable infiltration rate calculated using planning phase methods from Table D.3-1 greater than 0.5 inches per hour?</p> <p><input type="checkbox"/> Yes; the DMA may feasibly support full infiltration. Answer “Yes” to Criteria 1 Result.</p> <p><input checked="" type="checkbox"/> No; full infiltration is not required. Answer “No” to Criteria 1 Result.</p>	
<b>1D</b>	<p><b>Infiltration Testing Method.</b> Is the selected infiltration testing method suitable during the design phase (see Appendix D.3)? Note: Alternative testing standards may be allowed with appropriate rationales and documentation.</p> <p><input type="checkbox"/> Yes; continue to Step 1E.</p> <p><input type="checkbox"/> No; select an appropriate infiltration testing method.</p>	
<b>1E</b>	<p><b>Number of Percolation/Infiltration Tests.</b> Does the infiltration testing method performed satisfy the minimum number of tests specified in Table D.3-2?</p> <p><input type="checkbox"/> Yes; continue to Step 1F.</p> <p><input type="checkbox"/> No; conduct appropriate number of tests.</p>	

<sup>1</sup> This form must be completed each time there is a change to the site layout that would affect the infiltration feasibility condition. Previously completed forms shall be retained to document the evolution of the site storm water design.

<sup>2</sup> Available data includes site-specific sampling or observation of soil types or texture classes, such as obtained from borings or test pits necessary to support other design elements.





Project Name: \_\_\_\_\_

Categorization of Infiltration Feasibility Condition based on Geotechnical Conditions		Form I-8A <sup>1</sup> (Worksheet C.4-1)
<b>IF</b>	<p><b>Factor of Safety.</b> Is the suitable Factor of Safety selected for full infiltration design? See guidance in D.5; Tables D.5-1 and D.5-2; and Worksheet D.5-1 (Form I-9).</p> <p><input type="checkbox"/> Yes; continue to Step 1G.  <input type="checkbox"/> No; select appropriate factor of safety.</p>	
<b>1G</b>	<p><b>Full Infiltration Feasibility.</b> Is the average measured infiltration rate divided by the Factor of Safety greater than 0.5 inches per hour?</p> <p><input type="checkbox"/> Yes; answer “Yes” to Criteria 1 Result.  <input type="checkbox"/> No; answer “No” to Criteria 1 Result.</p>	
<b>Criteria 1 Result</b>	<p>Is the estimated reliable infiltration rate greater than 0.5 inches per hour within the DMA where runoff can reasonably be routed to a BMP?</p> <p><input type="checkbox"/> Yes; the DMA may feasibly support full infiltration. Continue to Criteria 2.  <input checked="" type="checkbox"/> No; full infiltration is not required. Skip to Part 1 Result.</p>	
<p>Summarize infiltration testing methods, testing locations, replicates, and results and summarize estimates of reliable infiltration rates according to procedures outlined in D.5. Documentation should be included in project geotechnical report.</p> <p><b>Infiltration was performed at two locations within the project site using borehole infiltration tests. The test results were as follows:</b></p> <p>A-1: 0.004 in/hr (0.002 in/hr using a factor of safety of 2.0 for feasibility determination)  A-2: 0.082 in/hr (0.041 in/hr using a factor of safety of 2.0 for feasibility determination)</p> <p><b>Infiltration test information is contained in the geotechnical investigation dated September 18, 2020.</b></p>		
<b>Criteria 2: Geologic/Geotechnical Screening</b>		
<b>2A</b>	<p><b>If all questions in Step 2A are answered “Yes,” continue to Step 2B.</b></p> <p>For any “No” answer in Step 2A answer “No” to Criteria 2 and submit an “Infiltration Feasibility Condition Letter” that meets the requirements in Appendix C.1.1.</p> <p>The geologic/geotechnical analyses listed in Appendix C.2.1 do not apply to the DMA because one of the following setbacks cannot be avoided and therefore result in the DMA being in a no infiltration condition. The setbacks must be the closest horizontal radial distance from the surface edge (at the overflow elevation) of the BMP.</p>	

Project Name: \_\_\_\_\_

Categorization of Infiltration Feasibility Condition based on Geotechnical Conditions		Form I-8A <sup>1</sup> (Worksheet C.4-1)	
2A-1	Can the proposed full infiltration BMP(s) avoid areas with existing fill materials greater than 5 feet thick below the infiltrating surface?	<input type="checkbox"/> Yes	<input type="checkbox"/> No
2A-2	Can the proposed full infiltration BMP(s) avoid placement within 10 feet of existing underground utilities, structures, or retaining walls?	<input type="checkbox"/> Yes	<input type="checkbox"/> No
2A-3	Can the proposed full infiltration BMP(s) avoid placement within 50 feet of a natural slope (>25%) or within a distance of 1.5H from fill slopes where H is the height of the fill slope?	<input type="checkbox"/> Yes	<input type="checkbox"/> No
<b>2B</b>	When full infiltration is determined to be feasible, a geotechnical investigation report must be prepared that considers the relevant factors identified in Appendix C.2.1. If all questions in Step 2B are answered “Yes,” then answer “Yes” to Criteria 2 Result. If there are “No” answers continue to Step 2C.		
2B-1	<b>Hydroconsolidation.</b> Analyze hydroconsolidation potential per approved ASTM standard due to a proposed full infiltration BMP. Can full infiltration BMPs be proposed within the DMA without increasing hydroconsolidation risks?	<input type="checkbox"/> Yes	<input type="checkbox"/> No
2B-2	<b>Expansive Soils.</b> Identify expansive soils (soils with an expansion index greater than 20) and the extent of such soils due to proposed full infiltration BMPs. Can full infiltration BMPs be proposed within the DMA without increasing expansive soil risks?	<input type="checkbox"/> Yes	<input type="checkbox"/> No
2B-3	<b>Liquefaction.</b> If applicable, identify mapped liquefaction areas. Evaluate liquefaction hazards in accordance with Section 6.4.2 of the City of San Diego's Guidelines for Geotechnical Reports (2011 or most recent edition). Liquefaction hazard assessment shall take into account any increase in groundwater elevation or groundwater mounding that could occur as a result of proposed infiltration or percolation facilities. Can full infiltration BMPs be proposed within the DMA without increasing liquefaction risks?	<input type="checkbox"/> Yes	<input type="checkbox"/> No
2B-4	<b>Slope Stability.</b> If applicable, perform a slope stability analysis in accordance with the ASCE and Southern California Earthquake Center (2002) Recommended Procedures for Implementation of DMG Special Publication 117, Guidelines for Analyzing and Mitigating Landslide Hazards in California to determine minimum slope setbacks for full infiltration BMPs. See the City of San Diego's Guidelines for Geotechnical Reports (2011) to determine which type of slope stability analysis is required. Can full infiltration BMPs be proposed within the DMA without increasing slope stability risks?	<input type="checkbox"/> Yes	<input type="checkbox"/> No
2B-5	<b>Other Geotechnical Hazards.</b> Identify site-specific geotechnical hazards not already mentioned (refer to Appendix C.2.1). Can full infiltration BMPs be proposed within the DMA without increasing risk of geologic or geotechnical hazards not already mentioned?	<input type="checkbox"/> Yes	<input type="checkbox"/> No

Project Name: \_\_\_\_\_

Categorization of Infiltration Feasibility Condition based on Geotechnical Conditions		Form I-8A <sup>1</sup> (Worksheet C.4-1)	
2B-6	<p><b>Setbacks.</b> Establish setbacks from underground utilities, structures, and/or retaining walls. Reference applicable ASTM or other recognized standard in the geotechnical report.</p> <p>Can full infiltration BMPs be proposed within the DMA using established setbacks from underground utilities, structures, and/or retaining walls?</p>	<input type="checkbox"/> Yes	<input type="checkbox"/> No
2C	<p><b>Mitigation Measures.</b> Propose mitigation measures for each geologic/geotechnical hazard identified in Step 2B. Provide a discussion of geologic/geotechnical hazards that would prevent full infiltration BMPs that cannot be reasonably mitigated in the geotechnical report. See Appendix C.2.1.8 for a list of typically reasonable and typically unreasonable mitigation measures.</p> <p>Can mitigation measures be proposed to allow for full infiltration BMPs? If the question in Step 2 is answered “Yes,” then answer “Yes” to Criteria 2 Result.</p> <p>If the question in Step 2C is answered “No,” then answer “No” to Criteria 2 Result.</p>	<input type="checkbox"/> Yes	<input type="checkbox"/> No
<b>Criteria 2 Result</b>	Can infiltration greater than 0.5 inches per hour be allowed without increasing risk of geologic or geotechnical hazards that cannot be reasonably mitigated to an acceptable level?	<input type="checkbox"/> Yes	<input type="checkbox"/> No
Summarize findings and basis; provide references to related reports or exhibits.			
<b>Part 1 Result – Full Infiltration Geotechnical Screening</b> <sup>3</sup>		<b>Result</b>	
<p>If answers to both Criteria 1 and Criteria 2 are “Yes”, a full infiltration design is potentially feasible based on Geotechnical conditions only.</p> <p>If either answer to Criteria 1 or Criteria 2 is “No”, a full infiltration design is not required.</p>		<input type="checkbox"/> <b>Full infiltration Condition</b> <input checked="" type="checkbox"/> <b>Complete Part 2</b>	

<sup>3</sup> To be completed using gathered site information and best professional judgement considering the definition of MEP in the MS4 Permit. Additional testing and/or studies may be required by City Engineer to substantiate findings.



Project Name: \_\_\_\_\_

Categorization of Infiltration Feasibility Condition based on Geotechnical Conditions		Form I-8A <sup>1</sup> (Worksheet C.4-1)
<b>Part 2 – Partial vs. No Infiltration Feasibility Screening Criteria</b>		
<b>DMA(s) Being Analyzed:</b>		<b>Project Phase:</b>
Entire Site		Planning
<b>Criteria 3 : Infiltration Rate Screening</b>		
<b>3A</b>	<p><b>NRCS Type C, D, or “urban/unclassified”:</b> Is the mapped hydrologic soil group according to the NRCS Web Soil Survey or UC Davis Soil Web Mapper is Type C, D, or “urban/unclassified” and corroborated by available site soil data?</p> <p><input type="checkbox"/> Yes; the site is mapped as C soils and a reliable infiltration rate of 0.15 in/hr. is used to size partial infiltration BMPS. Answer “Yes” to Criteria 3 Result.</p> <p><input type="checkbox"/> Yes; the site is mapped as D soils or “urban/unclassified” and a reliable infiltration rate of 0.05 in/hr. is used to size partial infiltration BMPS. Answer “Yes” to Criteria 3 Result.</p> <p><input checked="" type="checkbox"/> No; infiltration testing is conducted (refer to Table D.3-1), continue to Step 3B.</p>	
<b>3B</b>	<p><b>Infiltration Testing Result:</b> Is the reliable infiltration rate (i.e. average measured infiltration rate/2) greater than 0.05 in/hr. and less than or equal to 0.5 in/hr?</p> <p><input type="checkbox"/> Yes; the site may support partial infiltration. Answer “Yes” to Criteria 3 Result.</p> <p><input checked="" type="checkbox"/> No; the reliable infiltration rate (i.e. average measured rate/2) is less than 0.05 in/hr., partial infiltration is not required. Answer “No” to Criteria 3 Result.</p>	
<b>Criteria 3 Result</b>	<p>Is the estimated reliable infiltration rate (i.e., average measured infiltration rate/2) greater than or equal to 0.05 inches/hour and less than or equal to 0.5 inches/hour at any location within each DMA where runoff can reasonably be routed to a BMP?</p> <p><input type="checkbox"/> Yes; Continue to Criteria 4.</p> <p><input checked="" type="checkbox"/> No: Skip to Part 2 Result.</p>	
<p>Summarize infiltration testing and/or mapping results (i.e. soil maps and series description used for infiltration rate).</p> <p>Infiltration testing was performed in the area of the proposed storm water BMP at the northwest corner of the property. The test results were as follows:</p> <p>A-1: 0.004 in/hr (0.002 in/hr using a factor of safety of 2.0 for feasibility determination)                      A-2: 0.082 in/hr (0.041 in/hr using a factor of safety of 2.0 for feasibility determination)</p> <p>This rate is not fast enough for partial infiltration.</p> <p>Infiltration test information is contained in the geotechnical investigation dated September 18, 2020.</p>		

Categorization of Infiltration Feasibility Condition based on Geotechnical Conditions		Form I-8A <sup>1</sup> (Worksheet C.4-1)	
<b>Criteria 4: Geologic/Geotechnical Screening</b>			
<b>4A</b>	<p>If all questions in Step 4A are answered “Yes,” continue to Step 2B.</p> <p>For any “No” answer in Step 4A answer “No” to Criteria 4 Result, and submit an “Infiltration Feasibility Condition Letter” that meets the requirements in Appendix C.1.1. The geologic/geotechnical analyses listed in Appendix C.2.1 do not apply to the DMA because one of the following setbacks cannot be avoided and therefore result in the DMA being in a no infiltration condition. The setbacks must be the closest horizontal radial distance from the surface edge (at the overflow elevation) of the BMP.</p>		
4A-1	Can the proposed partial infiltration BMP(s) avoid areas with existing fill materials greater than 5 feet thick?	<input type="checkbox"/> Yes	<input type="checkbox"/> No
4A-2	Can the proposed partial infiltration BMP(s) avoid placement within 10 feet of existing underground utilities, structures, or retaining walls?	<input type="checkbox"/> Yes	<input type="checkbox"/> No
4A-3	Can the proposed partial infiltration BMP(s) avoid placement within 50 feet of a natural slope (>25%) or within a distance of 1.5H from fill slopes where H is the height of the fill slope?	<input type="checkbox"/> Yes	<input type="checkbox"/> No
<b>4B</b>	<p>When full infiltration is determined to be feasible, a geotechnical investigation report must be prepared that considers the relevant factors identified in Appendix C.2.1.</p> <p>If all questions in Step 4B are answered “Yes,” then answer “Yes” to Criteria 4 Result. If there are any “No” answers continue to Step 4C.</p>		
4B-1	<p><b>Hydroconsolidation.</b> Analyze hydroconsolidation potential per approved ASTM standard due to a proposed full infiltration BMP.</p> <p>Can partial infiltration BMPs be proposed within the DMA without increasing hydroconsolidation risks?</p>	<input type="checkbox"/> Yes	<input type="checkbox"/> No
4B-2	<p><b>Expansive Soils.</b> Identify expansive soils (soils with an expansion index greater than 20) and the extent of such soils due to proposed full infiltration BMPs.</p> <p>Can partial infiltration BMPs be proposed within the DMA without increasing expansive soil risks?</p>	<input type="checkbox"/> Yes	<input type="checkbox"/> No
4B-3	<p><b>Liquefaction.</b> If applicable, identify mapped liquefaction areas. Evaluate liquefaction hazards in accordance with Section 6.4.2 of the City of San Diego's Guidelines for Geotechnical Reports (2011). Liquefaction hazard assessment shall take into account any increase in groundwater elevation or groundwater mounding that could occur as a result of proposed infiltration or percolation facilities.</p> <p>Can partial infiltration BMPs be proposed within the DMA without increasing liquefaction risks?</p>	<input type="checkbox"/> Yes	<input type="checkbox"/> No

Project Name: \_\_\_\_\_

Categorization of Infiltration Feasibility Condition based on Geotechnical Conditions		Form I-8A <sup>1</sup> (Worksheet C.4-1)	
4B-4	<p><b>Slope Stability.</b> If applicable, perform a slope stability analysis in accordance with the ASCE and Southern California Earthquake Center (2002) Recommended Procedures for Implementation of DMG Special Publication 117, Guidelines for Analyzing and Mitigating Landslide Hazards in California to determine minimum slope setbacks for full infiltration BMPs. See the City of San Diego's Guidelines for Geotechnical Reports (2011) to determine which type of slope stability analysis is required.</p> <p>Can partial infiltration BMPs be proposed within the DMA without increasing slope stability risks?</p>	<input type="checkbox"/> Yes	<input type="checkbox"/> No
4B-5	<p><b>Other Geotechnical Hazards.</b> Identify site-specific geotechnical hazards not already mentioned (refer to Appendix C.2.1).</p> <p>Can partial infiltration BMPs be proposed within the DMA without increasing risk of geologic or geotechnical hazards not already mentioned?</p>	<input type="checkbox"/> Yes	<input type="checkbox"/> No
4B-6	<p><b>Setbacks.</b> Establish setbacks from underground utilities, structures, and/or retaining walls. Reference applicable ASTM or other recognized standard in the geotechnical report.</p> <p>Can partial infiltration BMPs be proposed within the DMA using recommended setbacks from underground utilities, structures, and/or retaining walls?</p>	<input type="checkbox"/> Yes	<input type="checkbox"/> No
4C	<p><b>Mitigation Measures.</b> Propose mitigation measures for each geologic/geotechnical hazard identified in Step 4B. Provide a discussion on geologic/geotechnical hazards that would prevent partial infiltration BMPs that cannot be reasonably mitigated in the geotechnical report. See Appendix C.2.1.8 for a list of typically reasonable and typically unreasonable mitigation measures.</p> <p>Can mitigation measures be proposed to allow for partial infiltration BMPs? If the question in Step 4C is answered "Yes," then answer "Yes" to Criteria 4 Result.</p> <p>If the question in Step 4C is answered "No," then answer "No" to Criteria 4 Result.</p>	<input type="checkbox"/> Yes	<input type="checkbox"/> No
<b>Criteria 4 Result</b>	<p>Can infiltration of greater than or equal to 0.05 inches/hour and less than or equal to 0.5 inches/hour be allowed without increasing the risk of geologic or geotechnical hazards that cannot be reasonably mitigated to an acceptable level?</p>	<input type="checkbox"/> Yes	<input type="checkbox"/> No

Project Name: \_\_\_\_\_

Categorization of Infiltration Feasibility Condition based on Geotechnical Conditions	Form I-8A <sup>1</sup> (Worksheet C.4-1)
Summarize findings and basis; provide references to related reports or exhibits.	
Part 2 – Partial Infiltration Geotechnical Screening Result <sup>4</sup>	Result
<p>If answers to both Criteria 3 and Criteria 4 are “Yes”, a partial infiltration design is potentially feasible based on geotechnical conditions only.</p> <p>If answers to either Criteria 3 or Criteria 4 is “No”, then infiltration of any volume is considered to be infeasible within the site.</p>	<p><input type="checkbox"/> Partial Infiltration Condition</p> <p><input checked="" type="checkbox"/> No Infiltration Condition</p>

<sup>4</sup> To be completed using gathered site information and best professional judgement considering the definition of MEP in the MS4 Permit. Additional testing and/or studies may be required by City Engineer to substantiate findings.



**ATTACHMENT 1E – POLLUTANT CONTROL BMP DESIGN  
WORKSHEETS/CALCULATIONS**



# San Diego County 85th Percentile Isopluvials

**Legend**

- 85th PERCENTILE ISOPLUVIAL
- INCORPORATED CITY

**NOTE:**  
The 85th percentile is a 24 hour rainfall total. It represents a value such that 85% of the observed 24 hour rainfall totals will be less than that value.

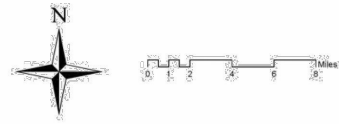

THIS MAP/DATA IS PROVIDED WITHOUT WARRANTY OF ANY KIND, EITHER EXPRESS OR IMPLIED, INCLUDING BUT NOT LIMITED TO, THE IMPLIED WARRANTIES OF MERCHANTABILITY AND FITNESS FOR A PARTICULAR PURPOSE. The user assumes all responsibility for any use of the information provided herein. This product may contain information from the SANDAG Regional Information System which cannot be reproduced without the written permission of SANDAG. This notice shall remain in effect regardless of any part thereof, whether for personal use or resale, or how the product is reproduced or transmitted in any form or by any means, electronic, mechanical, photocopying, recording, or by any information storage and retrieval system. Copyright 2014 LUEG GIS. All Rights Reserved. Full text of this legal notice can be found at: [http://www.luegis.com/privacy\\_policy.html](http://www.luegis.com/privacy_policy.html).



05040015  
P:\Work\CONTRACTS\140218\REVISED\_2016\  
PCT01\_DISPLAY.mxd

**PROJECT SITE**

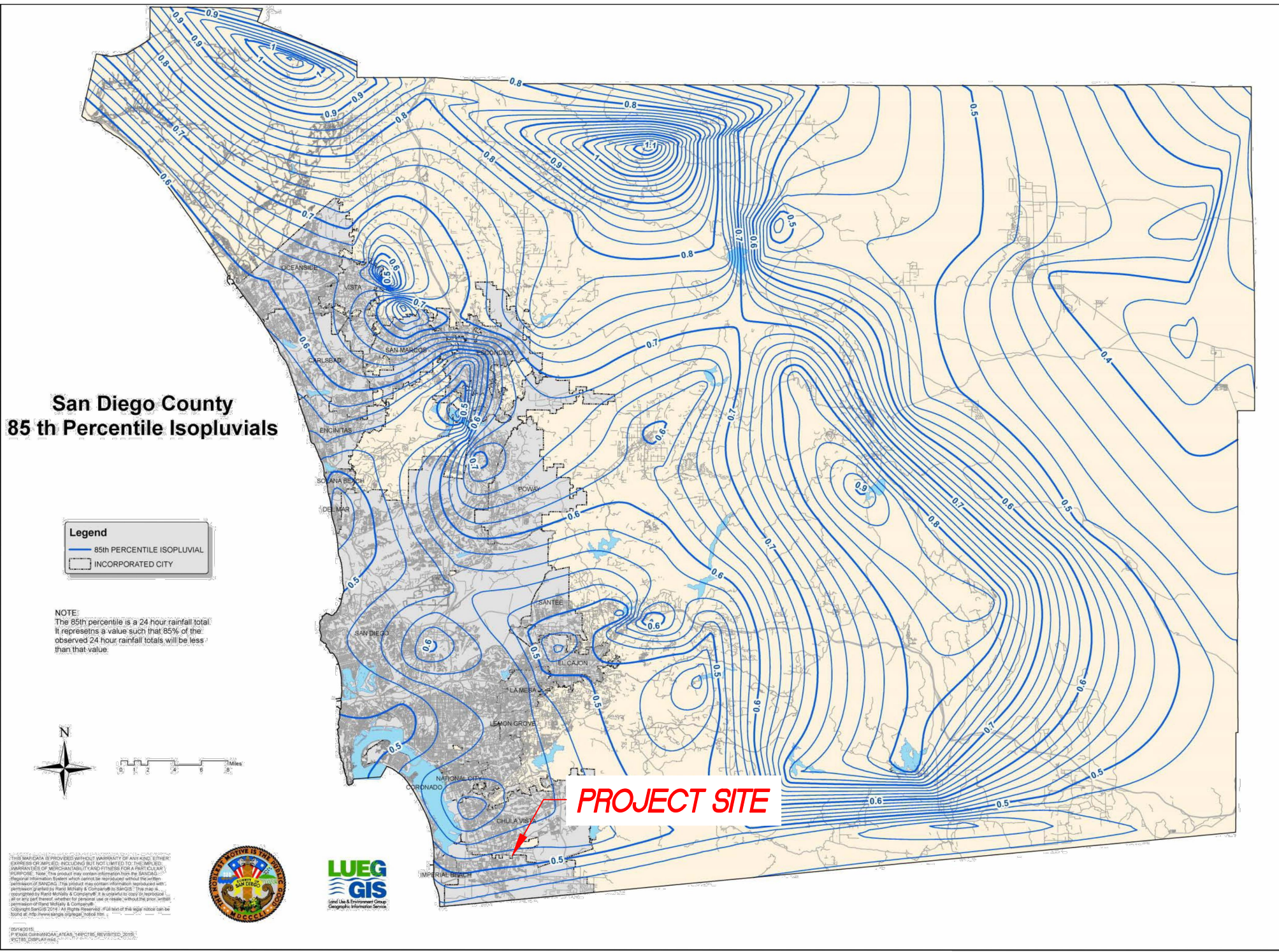

**ATTACHMENT 1B: Worksheet B.2-1: DCV**

85th percentile 24-hr storm depth from Figure B.1.= 0.515 in

DMA ID	BMP ID	BMP Drainage Area (ac)	BMP Drainage Area (SF)	Impervious Area (ac)	Amended Soils (ac) (C=0.1)	Natural A Soils (ac) (C=0.1)	Natural B Soils (ac) (C=0.14)	Natural C Soils (ac) (C=0.23)	Natural D Soils (ac) (C=0.3)	% Impervious	Composite C <sup>1</sup>	Tree Credit Volume (cf)	Rain Barrels Credit Volume (cf)	Design Capture Volume (DCV) (CF)
Project Site	1,2,3	20.3	884339	13.08	4.47			2.75	0	64.4%	0.633			24027

Notes:

1) Equation for composite C factor =  $(0.9 \times \text{Impervious Area} + C \times \text{Pervious Area}) / \text{Total Area}$  per BMP Design Manual.

C factors are from Table B.1-1 of August 2021 City BMP Design Manual.

2) Volume Retention will be met with Biofiltration Basins and Impervious Dispersion



**Project Name** Nakano

**BMP ID** Site

**Sizing Method for Volume Retention Criteria**

**Worksheet B.5-2**

1	Area draining to the BMP	884339	sq. ft.
2	Adjusted runoff factor for drainage area (Refer to Appendix B.1 and B.2)	0.633078818	
3	85 <sup>th</sup> percentile 24-hour rainfall depth	0.515	inches
4	Design capture volume [Line 1 x Line 2 x (Line 3/12)]	24027	cu. ft.
<b>Volume Retention Requirement</b>			
5	<p>Measured infiltration rate in the DMA</p> <p>Note:</p> <p>When mapped hydrologic soil groups are used enter 0.10 for NRCS Type D soils and for NRCS Type C soils enter 0.30</p> <p>When in no infiltration condition and the actual measured infiltration rate is unknown enter 0.0 if there are geotechnical and/or groundwater hazards identified in Appendix C or enter 0.05</p>	0	in/hr.
6	Factor of safety	2	
7	Reliable infiltration rate, for biofiltration BMP sizing [Line 5 / Line 6]	0	in/hr.
8	<p>Average annual volume reduction target (Figure B.5-2)</p> <p>When Line 7 &gt; 0.01 in/hr. = Minimum (40, 166.9 x Line 7 + 6.62)</p> <p>When Line 7 ≤ 0.01 in/hr. = 3.5%</p>	3.5	%
9	<p>Fraction of DCV to be retained (Figure B.5-3)</p> <p>When Line 8 &gt; 8% =</p> $0.0000013 \times \text{Line } 8^3 - 0.000057 \times \text{Line } 8^2 + 0.0086 \times \text{Line } 8 - 0.014$ <p>When Line 8 ≤ 8% = 0.023</p>	0.023	
10	Target volume retention [Line 9 x Line 4]	553	cu. ft.



**Project Name** Nakano

**BMP ID** Site

**Volume Retention for No Infiltration Condition**

**Worksheet B.5-6**

1	Area draining to the biofiltration BMP	884339	sq. ft.
2	Adjusted runoff factor for drainage area (Refer to Appendix B.1 and B.2)	0.63307882	
3	Effective impervious area draining to the BMP [Line 1 x Line 2]	559856	sq. ft.
4	Required area for Evapotranspiration [Line 3 x 0.03]	16796	sq. ft.
5	Biofiltration BMP Footprint	8131	sq. ft.
<b>Landscape Area (must be identified on DS-3247)</b>			
	<b>Identification</b>	<b>1</b>	<b>2</b>
		<b>3</b>	<b>4</b>
		<b>5</b>	
6	Landscape area that meet the requirements in SD-B and SD-F Fact Sheet (sq. ft.)	11469	
7	Impervious area draining to the landscape area (sq. ft.)	13651	
8	Impervious to Pervious Area ratio [Line 7/Line 6]	1.19	0.00
9	Effective Credit Area If (Line 8 >1.5, Line 6, Line 7/1.5)	9101	0
10	Sum of Landscape area [sum of Line 9 Id's 1 to 5]	9101	sq. ft.
11	Provided footprint for evapotranspiration [Line 5 + Line 10]	17232	sq. ft.
<b>Volume Retention Performance Standard</b>			
12	Is Line 11 ≥ Line 4?	Volume Retention Performance Standard is Met	
13	Fraction of the performance standard met through the BMP footprint and/or landscaping [Line 11/Line 4]	1.03	
14	Target Volume Retention [Line 10 from Worksheet B.5.2]	553	cu. ft.
15	Volume retention required from other site design BMPs [(1-Line 13) x Line 14]	-16.57874435	cu. ft.
<b>Site Design BMP</b>			
	<b>Identification</b>	<b>Site Design Type</b>	<b>Credit</b>
16	1		cu. ft.
	2		cu. ft.
	3		cu. ft.
	4		cu. ft.
	5		cu. ft.
	Sum of volume retention benefits from other site design BMPs (e.g. trees; rain barrels etc.). [sum of Line 16 Credits for Id's 1 to 5] Provide documentation of how the site design credit is calculated in the PDP SWQMP.	0	cu. ft.
17	Is Line 16 ≥ Line 15?	Volume Retention Performance Standard is Met	

**ATTACHMENT 1B: Worksheet B.2-1: DCV**

85th percentile 24-hr storm depth from Figure B.1.= 0.515 in

DMA ID	BMP ID	BMP Drainage Area (ac)	BMP Drainage Area (SF)	Impervious Area (ac)	Amended Soils (ac) (C=0.1)	Natural A Soils (ac) (C=0.1)	Natural B Soils (ac) (C=0.14)	Natural C Soils (ac) (C=0.23)	Natural D Soils (ac) (C=0.3)	% Impervious	Composite C <sup>1</sup>	Tree Credit Volume (cf)	Rain Barrels Credit Volume (cf)	Design Capture Volume (DCV) (CF)
1	1	2.49	108312	1.77	0.72			0		71.1%	0.669			3108

Notes:

1) Equation for composite C factor =  $(0.9 \times \text{Impervious Area} + C \times \text{Pervious Area}) / \text{Total Area}$  per BMP Design Manual.

C factors are from Table B.1-1 of August 2021 City BMP Design Manual.

CALCULATION FOR MEDIA FILTRATION RATE WHEN CONTROLLED BY UNDERDRAIN ORIFICE

Surface ponding [6 inch minimum, 12 inch maximum]	6
Media thickness [18 inches minimum], also add mulch layer and washed ASTM 33 fine aggregate sand thickness to this line for sizing calculations	24
Aggregate storage (also add ASTM No 8 stone) above underdrain invert (12 inches typical) – use 0 inches if the aggregate is not over the entire bottom surface area	12
Diameter of underdrain orifice	1 in
H	3.46
Max hydromod Q through underdrain	0.04884 cfs
Footprint of the BMP	3608 ft <sup>2</sup>
Media filtration rate to be used for sizing (maximum filtration rate of 5 in/hr. with no outlet control; if the filtration rate is controlled by the outlet use the outlet controlled rate (includes infiltration into the soil and flow rate through the outlet structure) which will be less than 5 in/hr.)	<b>0.58 in/hr</b>



**Project Name** Nakano

**BMP ID** 1

**Sizing Method for Pollutant Removal Criteria**

**Worksheet B.5-1**

1	Area draining to the BMP	108312	sq. ft.
2	Adjusted runoff factor for drainage area (Refer to Appendix B.1 and B.2)	0.668674699	
3	85 <sup>th</sup> percentile 24-hour rainfall depth	0.515	inches
4	Design capture volume [Line 1 x Line 2 x (Line 3/12)]	3108	cu. ft.
<b>BMP Parameters</b>			
5	Surface ponding [6 inch minimum, 12 inch maximum]	6	inches
6	Media thickness [18 inches minimum], also add mulch layer and washed ASTM 33 fine aggregate sand thickness to this line for sizing calculations	24	inches
7	Aggregate storage (also add ASTM No 8 stone) above underdrain invert (12 inches typical) – use 0 inches if the aggregate is not over the entire bottom surface area	12	inches
8	Aggregate storage below underdrain invert (3 inches minimum) – use 0 inches if the aggregate is not over the entire bottom surface area	3	inches
9	Freely drained pore storage of the media	0.2	in/in
10	Porosity of aggregate storage	0.4	in/in
11	Media filtration rate to be used for sizing (maximum filtration rate of 5 in/hr. with no outlet control; if the filtration rate is controlled by the outlet use the outlet controlled rate (includes infiltration into the soil and flow rate through the outlet structure) which will be less than 5 in/hr.)	0.58	in/hr.
<b>Baseline Calculations</b>			
12	Allowable routing time for sizing	6	hours
13	Depth filtered during storm [ Line 11 x Line 12]	3.48	inches
14	Depth of Detention Storage [Line 5 + (Line 6 x Line 9) + (Line 7 x Line 10) + (Line 8 x Line 10)]	16.8	inches
15	Total Depth Treated [Line 13 + Line 14]	20.28	inches
<b>Option 1 – Biofilter 1.5 times the DCV</b>			
16	Required biofiltered volume [1.5 x Line 4]	4662	cu. ft.
17	Required Footprint [Line 16/ Line 15] x 12	2759	sq. ft.
<b>Option 2 - Store 0.75 of remaining DCV in pores and ponding</b>			
18	Required Storage (surface + pores) Volume [0.75 x Line 4]	2331	cu. ft.
19	Required Footprint [Line 18/ Line 14] x 12	1665	sq. ft.
<b>Footprint of the BMP</b>			
20	BMP Footprint Sizing Factor (Default 0.03 or an alternative minimum footprint sizing factor from Line 11 in Worksheet B.5-4)	0.03	
21	Minimum BMP Footprint [Line 1 x Line 2 x Line 20]	2173	sq. ft.
22	Footprint of the BMP = Maximum(Minimum(Line 17, Line 19), Line 21)	2173	sq. ft.
23	Provided BMP Footprint	3608	sq. ft.
24	Is Line 23 ≥ Line 22?	<b>Yes, Performance Standard is Met</b>	

**ATTACHMENT 1B: Worksheet B.2-1: DCV**

85th percentile 24-hr storm depth from Figure B.1.= 0.515 in

DMA ID	BMP ID	BMP Drainage Area (ac)	BMP Drainage Area (SF)	Impervious Area (ac)	Amended Soils (ac) (C=0.1)	Natural A Soils (ac) (C=0.1)	Natural B Soils (ac) (C=0.14)	Natural C Soils (ac) (C=0.23)	Natural D Soils (ac) (C=0.3)	% Impervious	Composite C <sup>1</sup>	Tree Credit Volume (cf)	Rain Barrels Credit Volume (cf)	Design Capture Volume (DCV) (CF)
2	2	4.01	174893	2.41	0.75			0.86		60.1%	0.609			4571

Notes:

1) Equation for composite C factor =  $(0.9 \times \text{Impervious Area} + C \times \text{Pervious Area}) / \text{Total Area}$  per BMP Design Manual.

C factors are from Table B.1-1 of Aug 2021 City BMP Design Manual.





CALCULATION FOR MEDIA FILTRATION RATE WHEN CONTROLLED BY UNDERDRAIN ORIFICE

Surface ponding [6 inch minimum, 12 inch maximum]	6
Media thickness [18 inches minimum], also add mulch layer and washed ASTM 33 fine aggregate sand thickness to this line for sizing calculations	24
Aggregate storage (also add ASTM No 8 stone) above underdrain invert (12 inches typical) – use 0 inches if the aggregate is not over the entire bottom surface area	12
Diameter of underdrain orifice	1 in
H	3.46
Max hydromod Q through underdrain	0.04884 cfs
Footprint of the BMP	684 ft <sup>2</sup>
Media filtration rate to be used for sizing (maximum filtration rate of 5 in/hr. with no outlet control; if the filtration rate is controlled by the outlet use the outlet controlled rate (includes infiltration into the soil and flow rate through the outlet structure) which will be less than 5 in/hr.)	<b>3.08 in/hr</b>



**Project Name** Nakano

**BMP ID** 2

**Sizing Method for Pollutant Removal Criteria**

**Worksheet B.5-1**

1	Area draining to the BMP	174893	sq. ft.
2	Adjusted runoff factor for drainage area (Refer to Appendix B.1 and B.2)	0.608927681	
3	85 <sup>th</sup> percentile 24-hour rainfall depth	0.515	inches
4	Design capture volume [Line 1 x Line 2 x (Line 3/12)]	4571	cu. ft.

**BMP Parameters**

5	Surface ponding [6 inch minimum, 12 inch maximum]	6	inches
6	Media thickness [18 inches minimum], also add mulch layer and washed ASTM 33 fine aggregate sand thickness to this line for sizing calculations	24	inches
7	Aggregate storage (also add ASTM No 8 stone) above underdrain invert (12 inches typical) – use 0 inches if the aggregate is not over the entire bottom surface area	15	inches
8	Aggregate storage below underdrain invert (3 inches minimum) – use 0 inches if the aggregate is not over the entire bottom surface area	3	inches
9	Freely drained pore storage of the media	0.2	in/in
10	Porosity of aggregate storage	0.4	in/in
11	Media filtration rate to be used for sizing (maximum filtration rate of 5 in/hr. with no outlet control; if the filtration rate is controlled by the outlet use the outlet controlled rate (includes infiltration into the soil and flow rate through the outlet structure) which will be less than 5 in/hr.)	3.08	in/hr.

**Baseline Calculations**

12	Allowable routing time for sizing	6	hours
13	Depth filtered during storm [ Line 11 x Line 12]	18.5069092	inches
14	Depth of Detention Storage [Line 5 + (Line 6 x Line 9) + (Line 7 x Line 10) + (Line 8 x Line 10)]	18	inches
15	Total Depth Treated [Line 13 + Line 14]	36.5069092	inches

**Option 1 – Biofilter 1.5 times the DCV**

16	Required biofiltered volume [1.5 x Line 4]	6856	cu. ft.
17	Required Footprint [Line 16/ Line 15] x 12	2254	sq. ft.

**Option 2 - Store 0.75 of remaining DCV in pores and ponding**

18	Required Storage (surface + pores) Volume [0.75 x Line 4]	3428	cu. ft.
19	Required Footprint [Line 18/ Line 14] x 12	2285	sq. ft.

**Footprint of the BMP**

20	BMP Footprint Sizing Factor (Default 0.03 or an alternative minimum footprint sizing factor from Line 11 in Worksheet B.5-4)	0.03	
21	Minimum BMP Footprint [Line 1 x Line 2 x Line 20]	3195	sq. ft.
22	Footprint of the BMP = Maximum(Minimum(Line 17, Line 19), Line 21)	3195	sq. ft.
23	Provided BMP Footprint	4523	sq. ft.

24	Is Line 23 ≥ Line 22?	<b>Yes, Performance Standard is Met</b>	
----	-----------------------	---	--

**ATTACHMENT 1B: Worksheet B.2-1: DCV**

85th percentile 24-hr storm depth from Figure B.1.= 0.515 in

DMA ID	BMP ID	BMP Drainage Area (ac)	BMP Drainage Area (SF)	Impervious Area (ac)	Amended Soils (ac) (C=0.1)	Natural A Soils (ac) (C=0.1)	Natural B Soils (ac) (C=0.14)	Natural C Soils (ac) (C=0.23)	Natural D Soils (ac) (C=0.3)	% Impervious	Composite C <sup>1</sup>	Tree Credit Volume (cf)	Rain Barrels Credit Volume (cf)	Design Capture Volume (DCV) (CF)
3	3	13.8	601134	8.95	2.95			1.9	0	64.9%	0.637			16427

Notes:

1) Equation for composite C factor =  $(0.9 \times \text{Impervious Area} + C \times \text{Pervious Area}) / \text{Total Area}$  per BMP Design Manual.

C factors are from Table B.1-1 of Aug 2021 City BMP Design Manual.

Vault Drawdown

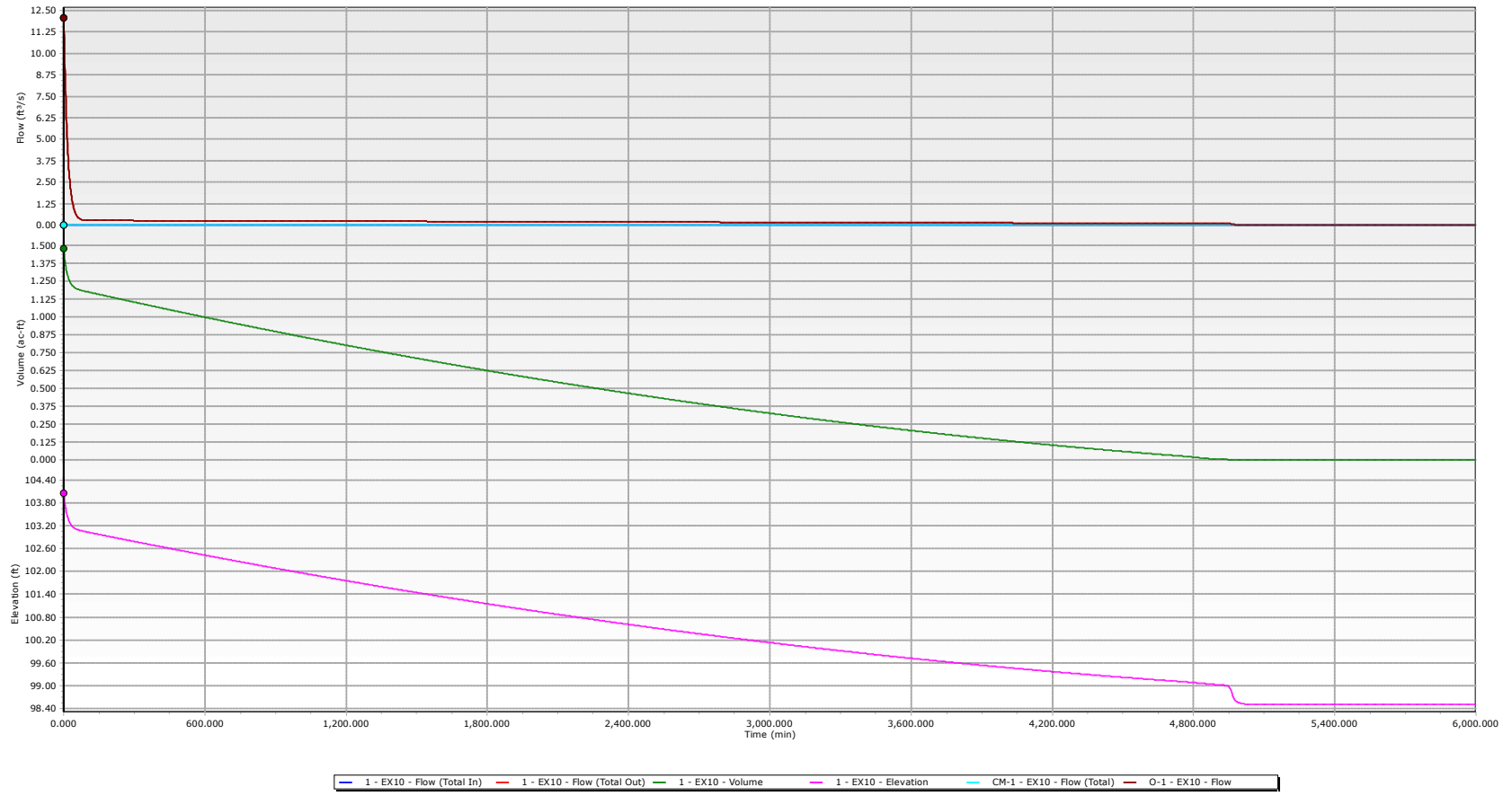

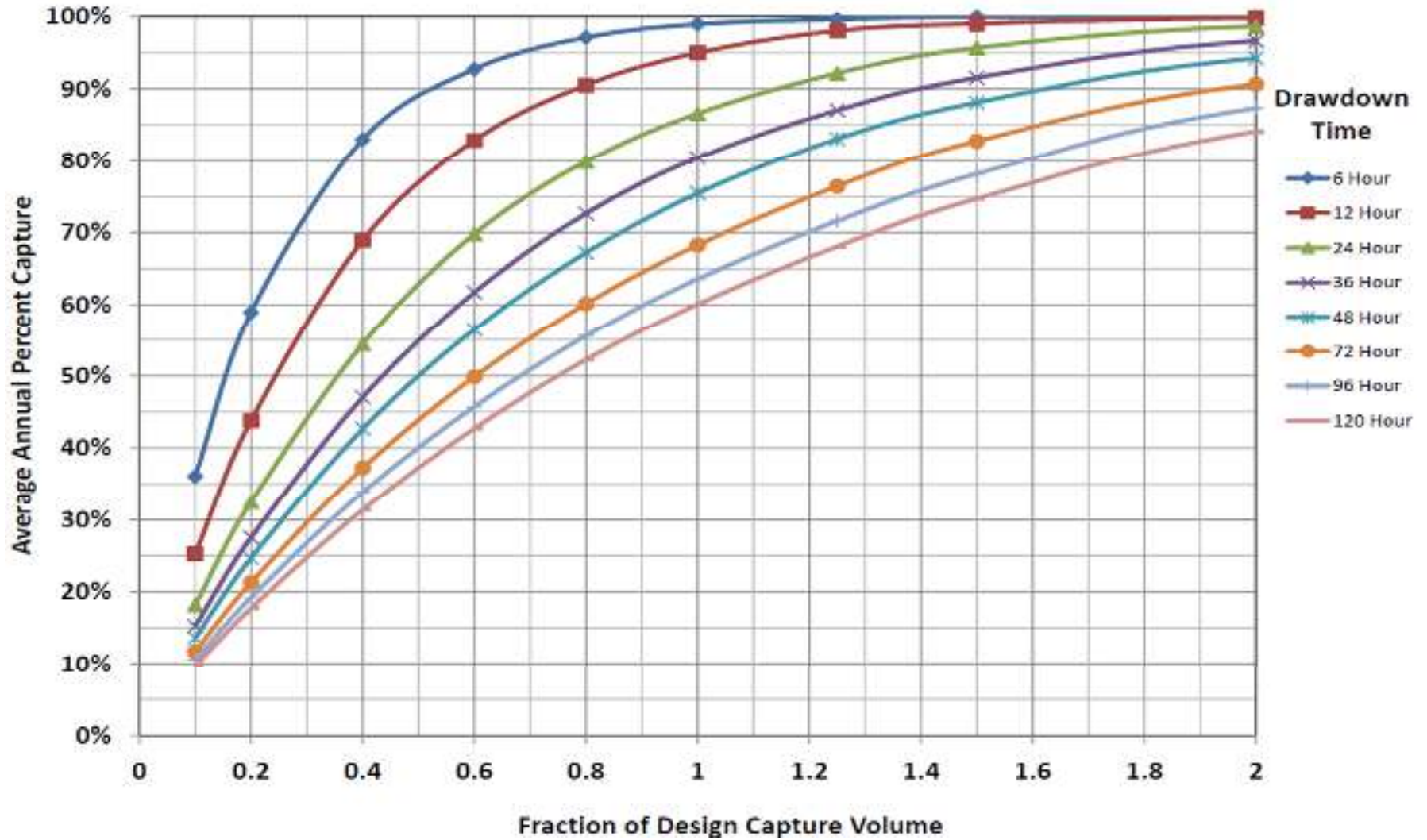

Figure B.4-1: Percent Capture Nomograph

## **B.5.2.2 Sizing Biofiltration BMPs Downstream of a Storage Unit**

### **Introduction**

In scenarios, where the BMP footprint is governed based on Option 1 (Line 17 of Worksheet B.5-1) or the required volume reduction for partial infiltration conditions (Line 10 of Worksheet B.5-2) the footprint of the biofiltration BMP can be reduced using the sizing calculations in this **Appendix B.5.2.2** when there is an upstream storage unit (e.g. cistern) that can be used to regulate the flows through the biofiltration BMP.

When this approach is used for sizing biofiltration BMPs the applicant must also verify that the storage unit meets the hydromodification management drawdown requirements and the discharge from the downstream biofiltration BMP will still meet the hydromodification flow control requirements. These calculations must be documented in the PDP SWQMP.

This methodology is **not** applicable when the minimum footprint factor is governed based on the alternative minimum footprint sizing factor calculated using Worksheet B.5-4 (Line 11). A biofiltration BMP smaller than the alternative minimum footprint sizing factor is considered compact biofiltration BMP and may be allowed at the discretion of the City Engineer if the BMP meets the requirements in **Appendix F** and the applicant submits a completed Form I-10.

### **Sizing Calculation**

Sizing calculations for the biofiltration footprint must demonstrate that one of the following two equivalent performance standards is met:

1. Use continuous simulation and demonstrate the following is met:
  - (a) The BMP or series of BMPs biofilters at least 92 percent of average annual (long term) runoff volume and achieves a volume reduction equivalent to Line 10 of **Worksheet B.5-2**. This can be demonstrated through reporting of output from the San Diego Hydrology Model, or through other continuous simulation modeling meeting the criteria in **Appendix G**, as acceptable to the City Engineer. The 92 percent of average annual runoff treatment corresponds to the average capture achieved by implementing a BMP with 1.5 times the DCV and a drawdown time of 36 hours (**Appendix B.4.2**).
2. Use the simple optimized method in **Worksheet B.5-5**. The applicant is also required to complete Worksheet B.5-1, B.5-2 and B.5-4 when the applicant elects to use Worksheet B.5-5 to reduce the biofiltration BMP footprint. **Worksheet B.5-5** was developed to satisfy the following two criteria as applicable:
  - (a) Greater than 92 percent of the average annual runoff volume from the storage unit is routed to the biofiltration BMP through the low flow orifice and the peak flow from the low flow orifice can instantaneously be filtered through the biofiltration media. If the outlet design for the storage unit includes orifices at different elevations and an overflow structure, only flows from the overflow structure should be excluded from the calculation (both for 92 percent capture and for peak flow to the biofiltration BMP that needs to be instantaneously filtered), unless the flows from other orifices also bypass the biofiltration BMP, in which case flows from the orifices that bypass should also be excluded.

Table B.5-5

Drawdown Time (hours)	Storage requirement (below the overflow elevation, or below outlet elevation that bypass the biofiltration BMP)
12	0.85 DCV
24	1.25 DCV
36	1.50 DCV
48	1.80 DCV
72	2.20 DCV
96	2.60 DCV
120	2.80 DCV



**PROJECT DESIGN CONSULTANTS**

PLANNING | LANDSCAPE ARCHITECTURE  
ENGINEERING | SURVEY

WWW.PROJECTDESIGN.COM

PROJECT NAKANO BMP System  
SUBJECT \_\_\_\_\_

PAGE : \_\_\_\_\_ OF \_\_\_\_\_ JOB NO. : \_\_\_\_\_

DRAWN BY : J.N. DATE : 6/22/22

CHECKED BY : \_\_\_\_\_ DATE : \_\_\_\_\_

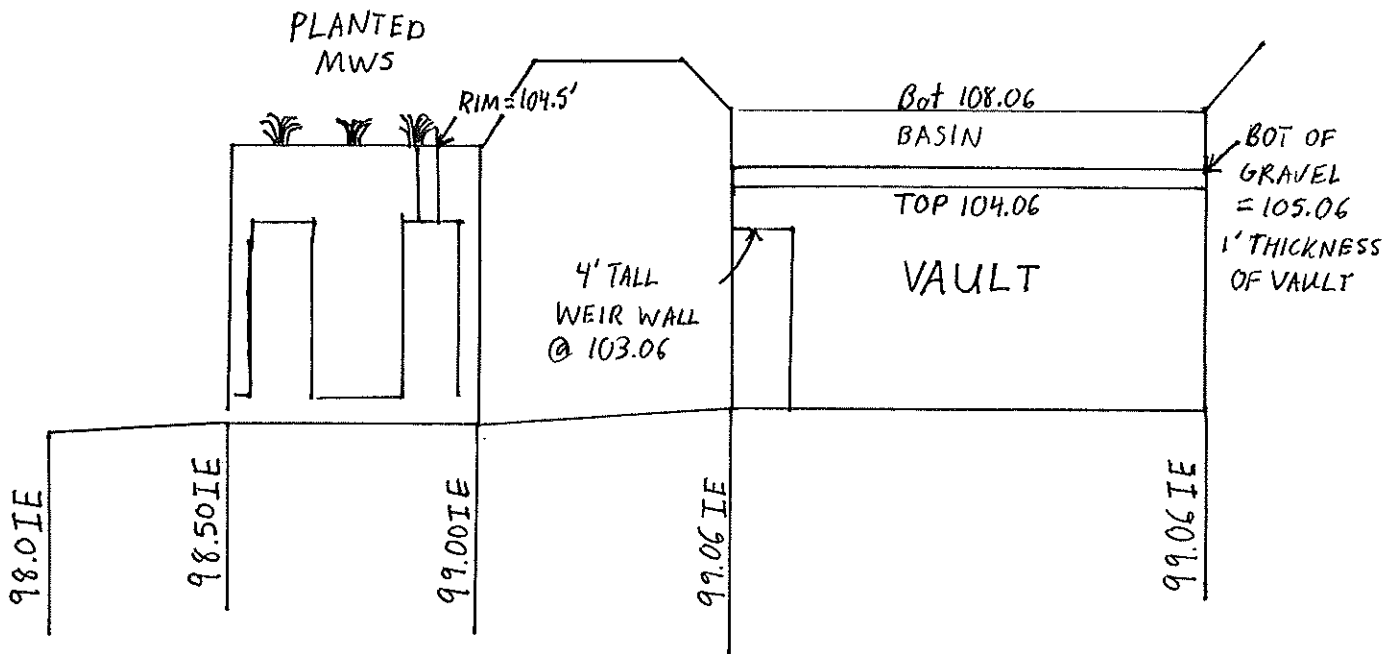

VAULT  
12,376 ft<sup>2</sup> AREA  
5 ft DEPTH

2 - 1.48" ORIFICES @ BOT MWS ELEV = 98.5' (EQUATES TO 1 - 2.2" ORIFICE)

4' WEIR WALL @ 103.06' w/ 8' LENGTH

FOR BYPASS + EMERGENCY OVERFLOW



### Nakano Project MWS Calculations

Project Site DCV=	16427 ft <sup>3</sup>		
96 hour drawdown=2.6*DCV			
2.6*DCV=	42710 ft <sup>3</sup>		
$Q_{avg} = \text{Volume}/(96*3600)$			
$Q_{avg} =$	0.124 cfs		
$Q_{avg} =$	55.46 gpm	Conversion	
		448.8 gpm/cfs	
Volume based loading rate	0.28 gpm/sf		
Loading Rate = $Q_{avg}/A_{filter}$			
$A_{filter} = \text{Perimeter length} * \text{Height}$		Height used=	4.5 ft
P=	44.02 ft		
Perimeter Capacity of 8-24 Unit=	88.8 ft		
	44.02 ft <		88.8 ft
<b>MWS 8-24 Unit will work</b>			

SITE SPECIFIC DATA			
PROJECT NUMBER	14850		
PROJECT NAME	NAKANO		
PROJECT LOCATION	CHULA VISTA, CA		
STRUCTURE ID	N/A		
TREATMENT REQUIRED			
VOLUME BASED (CF)	FLOW BASED (CFS)		
42,710	N/A		
TREATMENT HGL AVAILABLE (FT)	N/K		
PEAK BYPASS REQUIRED (CFS) - IF APPLICABLE	N/A		
PIPE DATA	I.E.	MATERIAL	DIAMETER
INLET PIPE 1	99.00	PVC	8"
INLET PIPE 2	N/A	N/A	N/A
OUTLET PIPE	98.50	PVC	8"
	PRETREATMENT	BIOFILTRATION	DISCHARGE
RIM ELEVATION	104.50	104.50	104.50
SURFACE LOAD	PEDESTRIAN	N/A	PEDESTRIAN
FRAME & COVER	3EA Ø30"	OPEN PLANTER	2EA Ø30"
WETLANDMEDIA VOLUME (CY)	18.00		
ORIFICE SIZE (DIA. INCHES)	Ø1.48 EA		
NOTES: PRELIMINARY NOT FOR CONSTRUCTION. UPSTREAM BYPASS WEIR SET AT 103.06			

**INSTALLATION NOTES**

- CONTRACTOR TO PROVIDE ALL LABOR, EQUIPMENT, MATERIALS AND INCIDENTALS REQUIRED TO OFFLOAD AND INSTALL THE SYSTEM AND APPURTENANCES IN ACCORDANCE WITH THIS DRAWING AND THE MANUFACTURERS' SPECIFICATIONS, UNLESS OTHERWISE STATED IN MANUFACTURER'S CONTRACT.
- UNIT MUST BE INSTALLED ON LEVEL BASE. MANUFACTURER RECOMMENDS A MINIMUM 6" LEVEL ROCK BASE UNLESS SPECIFIED BY THE PROJECT ENGINEER. CONTRACTOR IS RESPONSIBLE FOR VERIFYING PROJECT ENGINEER'S RECOMMENDED BASE SPECIFICATIONS.
- CONTRACTOR TO SUPPLY AND INSTALL ALL EXTERNAL CONNECTING PIPES. ALL PIPES MUST BE FLUSH WITH INSIDE SURFACE OF CONCRETE (PIPES CANNOT INTRUDE BEYOND FLUSH). INVERT OF OUTFLOW PIPE MUST BE FLUSH WITH DISCHARGE CHAMBER FLOOR. ALL PIPES SHALL BE SEALED WATERTIGHT PER MANUFACTURER'S STANDARD CONNECTION DETAIL.
- CONTRACTOR RESPONSIBLE FOR INSTALLATION OF ALL PIPES, RISERS, MANHOLES, AND HATCHES. CONTRACTOR TO USE GROUT AND/OR BRICKS TO MATCH COVERS WITH FINISHED SURFACE UNLESS SPECIFIED OTHERWISE.
- VEGETATION SUPPLIED AND INSTALLED BY OTHERS. ALL UNITS WITH VEGETATION MUST HAVE DRIP OR SPRAY IRRIGATION SUPPLIED AND INSTALLED BY OTHERS.
- CONTRACTOR RESPONSIBLE FOR CONTACTING BIO CLEAN FOR ACTIVATION OF UNIT. MANUFACTURER'S WARRANTY IS VOID WITHOUT PROPER ACTIVATION BY A BIO CLEAN REPRESENTATIVE.

**GENERAL NOTES**

- MANUFACTURER TO PROVIDE ALL MATERIALS UNLESS OTHERWISE NOTED.
- ALL DIMENSIONS, ELEVATIONS, SPECIFICATIONS AND CAPACITIES ARE SUBJECT TO CHANGE. FOR PROJECT SPECIFIC DRAWINGS DETAILING EXACT DIMENSIONS, WEIGHTS AND ACCESSORIES PLEASE CONTACT BIO CLEAN.

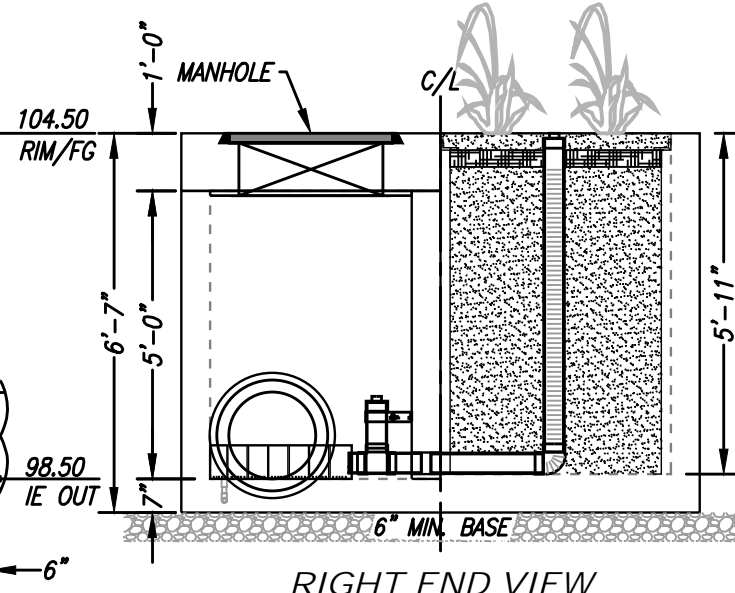
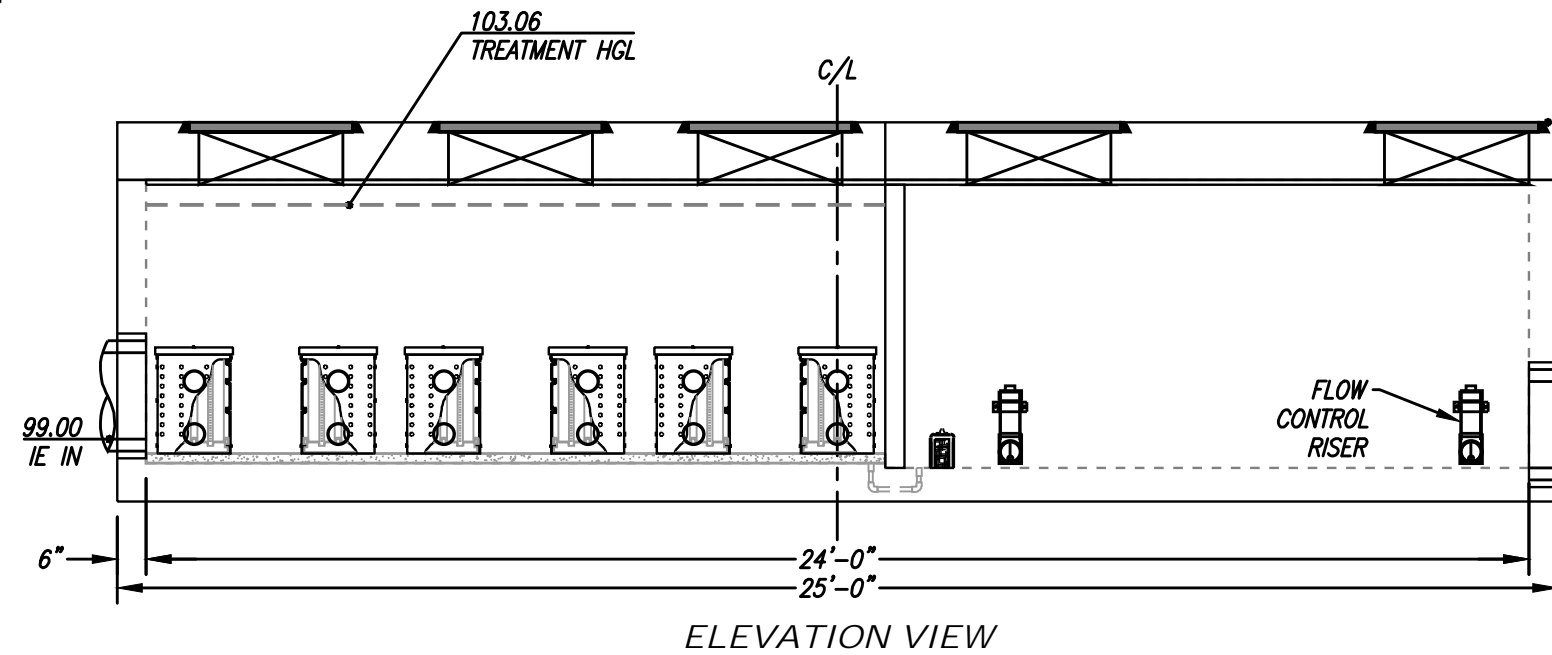
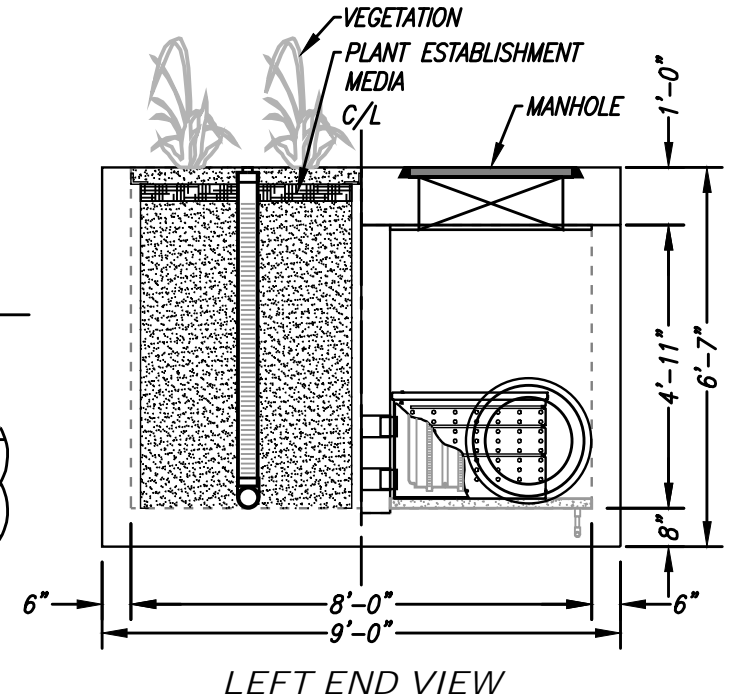
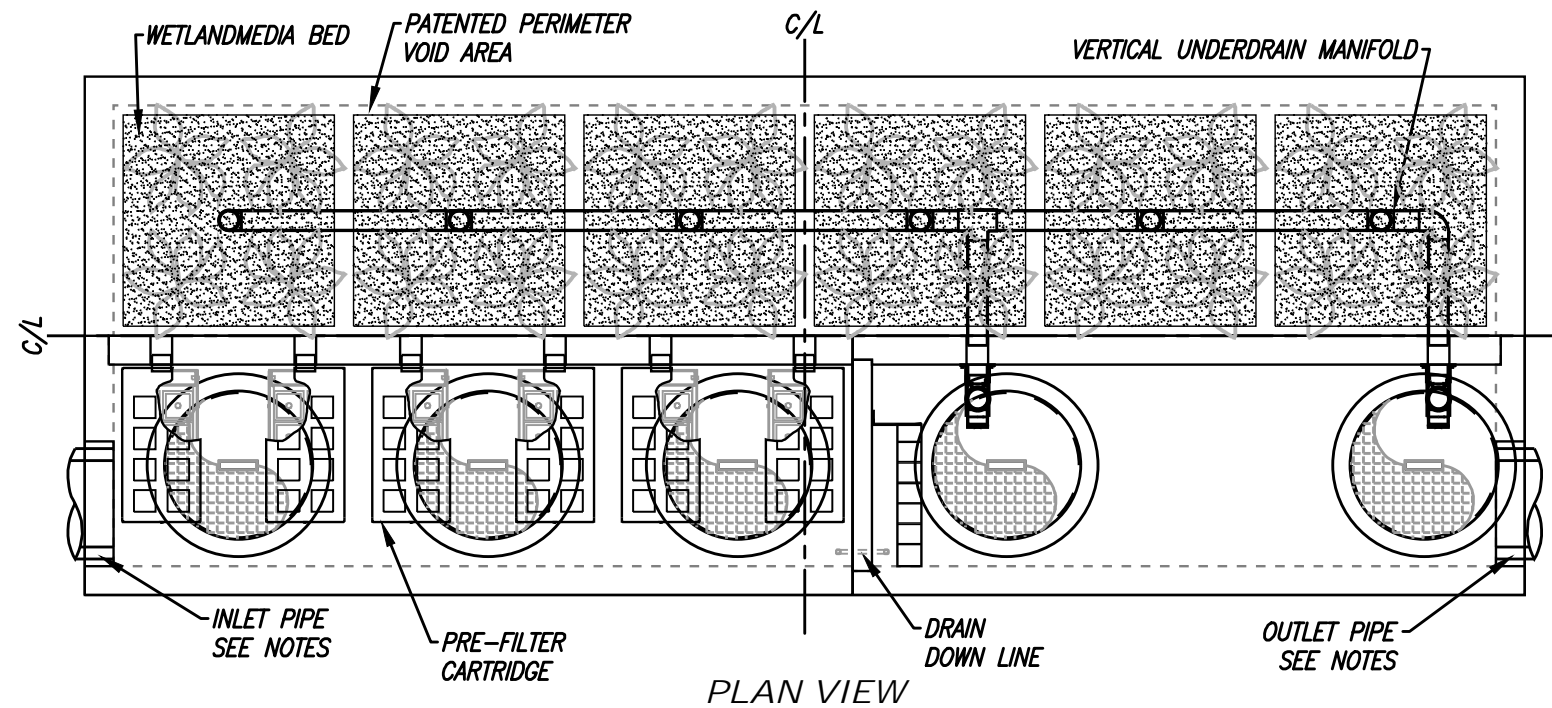

REQUIRED TREATMENT VOLUME (CF)	42,710
DRAINDOWN DURATION (HOURS)	82
AVERAGE DISCHARGE RATE PER MWS UNIT(GPM)	110.69
OPERATING HEAD (FT)	4.5
WETLANDMEDIA INFILTRATION RATE (IN/HR)	27.7
WETLANDMEDIA LOADING RATE (GPM/SF)	OR 0.28

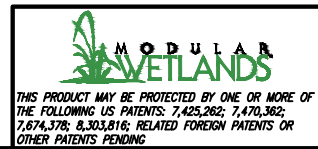

PROPRIETARY AND CONFIDENTIAL:  
THE INFORMATION CONTAINED IN THIS DOCUMENT IS THE SOLE PROPERTY OF FORTERRA AND ITS COMPANIES. THIS DOCUMENT, INOR ANY PART THEREOF, MAY BE USED, REPRODUCED OR MODIFIED IN ANY MANNER WITH OUT THE WRITTEN CONSENT OF FORTERRA.



**MWS-L-8-24-5'-11\"/>**

6/23/22/REVIEWS



A Forterra Company

# MWS SIZING Nakano Chula Vista, CA

---

**Mike Billings**

**06/23/2022**



## A Forterra Company

The MWS Linear will be sized in accordance with its TAPE GULD approval. The system is approved at a loading rate of 1 gpm/sq ft. The MWS Linear has General Use Level Designation at this loading rate for TSS (Basic), phosphorous and dissolved metals (Enhanced). For this project design, sizing, loading will be reviewed by a Modular Wetland representative for final approval to ensure the system is sized appropriately.

For this project we are sizing the MWS units to treat a large volume. Due to this large volume, we are using a 72% safety factor on our media loading rate and only sizing at a loading rate of 0.277 gpm/sf. Using a safety factor between 65% and 75% will greatly prolong the life of the Wetland MEDIA and decrease the long-term maintenance costs.

The orifice has been sized using the standard orifice sizing below. Sizing is based on the discharge rate of 110.69 gpm split between the two orifices.  $110.69 \text{ gpm} / 2 = 55.35 \text{ gpm}$

### **MWS ORIFICE SIZING**

$$\text{Given that: } Q = VA; \text{ } Q = \text{treatment flow rate, } V = c_d \sqrt{2gh}, A = \frac{\pi D^2}{4}$$

*c<sub>d</sub> is the discharge coefficient & h is the treatment HGL*

*Rewrite to solve for the diameter of the orifice.*

$$\left[ A = \frac{Q}{V} \right] \xrightarrow{\text{rewrite}} \frac{\pi D^2}{4} = \frac{Q}{c_d \sqrt{2gh}}$$

$$D = \sqrt{\frac{4Q}{\pi c_d \sqrt{2gh}}}; c_d = c_v c_c = (0.98)(0.62) = 0.6076$$

### **MWS-L-8-24-V-HC:**

*Given: Q = 55.35 gpm(per orifice) = 0.123 cfs, h = 4.5 ft*

$$D = \sqrt{\frac{4(0.123)}{\pi(0.6076)\sqrt{2(32.17)(4.5)}}} = 0.123' = \boxed{1.48" \text{ each}}$$

*The diameter of each orifice needs to be 1.48" in order to produce a head of 4.5' in the MWS unit.*



**July 2017**

## **GENERAL USE LEVEL DESIGNATION FOR BASIC, ENHANCED, AND PHOSPHORUS TREATMENT**

**For the**

### **MWS-Linear Modular Wetland**

#### **Ecology's Decision:**

Based on Modular Wetland Systems, Inc. application submissions, including the Technical Evaluation Report, dated April 1, 2014, Ecology hereby issues the following use level designation:

1. General use level designation (GULD) for the MWS-Linear Modular Wetland Stormwater Treatment System for Basic treatment
  - Sized at a hydraulic loading rate of 1 gallon per minute (gpm) per square foot (sq ft) of wetland cell surface area. For moderate pollutant loading rates (low to medium density residential basins), size the Prefilters at 3.0 gpm/sq ft of cartridge surface area. For high loading rates (commercial and industrial basins), size the Prefilters at 2.1 gpm/sq ft of cartridge surface area.
2. General use level designation (GULD) for the MWS-Linear Modular Wetland Stormwater Treatment System for Phosphorus treatment
  - Sized at a hydraulic loading rate of 1 gallon per minute (gpm) per square foot (sq ft) of wetland cell surface area. For moderate pollutant loading rates (low to medium density residential basins), size the Prefilters at 3.0 gpm/sq ft of cartridge surface area. For high loading rates (commercial and industrial basins), size the Prefilters at 2.1 gpm/sq ft of cartridge surface area.
3. General use level designation (GULD) for the MWS-Linear Modular Wetland Stormwater Treatment System for Enhanced treatment
  - Sized at a hydraulic loading rate of 1 gallon per minute (gpm) per square foot (sq ft) of wetland cell surface area. For moderate pollutant loading rates (low to medium density residential basins), size the Prefilters at 3.0 gpm/sq ft of cartridge surface area. For high loading rates (commercial and industrial basins), size the Prefilters at 2.1 gpm/sq ft of cartridge surface area.

4. Ecology approves the MWS - Linear Modular Wetland Stormwater Treatment System units for Basic, Phosphorus, and Enhanced treatment at the hydraulic loading rate listed above. Designers shall calculate the water quality design flow rates using the following procedures:

- Western Washington: For treatment installed upstream of detention or retention, the water quality design flow rate is the peak 15-minute flow rate as calculated using the latest version of the Western Washington Hydrology Model or other Ecology-approved continuous runoff model.
- Eastern Washington: For treatment installed upstream of detention or retention, the water quality design flow rate is the peak 15-minute flow rate as calculated using one of the three methods described in Chapter 2.2.5 of the Stormwater Management Manual for Eastern Washington (SWMMEW) or local manual.
- Entire State: For treatment installed downstream of detention, the water quality design flow rate is the full 2-year release rate of the detention facility.

5. These use level designations have no expiration date but may be revoked or amended by Ecology, and are subject to the conditions specified below.

**Ecology's Conditions of Use:**

Applicants shall comply with the following conditions:

1. Design, assemble, install, operate, and maintain the MWS – Linear Modular Wetland Stormwater Treatment System units, in accordance with Modular Wetland Systems, Inc. applicable manuals and documents and the Ecology Decision.
2. Each site plan must undergo Modular Wetland Systems, Inc. review and approval before site installation. This ensures that site grading and slope are appropriate for use of a MWS – Linear Modular Wetland Stormwater Treatment System unit.
3. MWS – Linear Modular Wetland Stormwater Treatment System media shall conform to the specifications submitted to, and approved by, Ecology.
4. The applicant tested the MWS – Linear Modular Wetland Stormwater Treatment System with an external bypass weir. This weir limited the depth of water flowing through the media, and therefore the active treatment area, to below the root zone of the plants. This GULD applies to MWS – Linear Modular Wetland Stormwater Treatment Systems whether plants are included in the final product or not.
5. Maintenance: The required maintenance interval for stormwater treatment devices is often dependent upon the degree of pollutant loading from a particular drainage basin. Therefore, Ecology does not endorse or recommend a “one size fits all” maintenance cycle for a particular model/size of manufactured filter treatment device.

- Typically, Modular Wetland Systems, Inc. designs MWS - Linear Modular Wetland systems for a target prefilter media life of 6 to 12 months.
- Indications of the need for maintenance include effluent flow decreasing to below the design flow rate or decrease in treatment below required levels.
- Owners/operators must inspect MWS - Linear Modular Wetland systems for a minimum of twelve months from the start of post-construction operation to determine site-specific

maintenance schedules and requirements. You must conduct inspections monthly during the wet season, and every other month during the dry season. (According to the SWMMWW, the wet season in western Washington is October 1 to April 30. According to SWMMEW, the wet season in eastern Washington is October 1 to June 30). After the first year of operation, owners/operators must conduct inspections based on the findings during the first year of inspections.

- Conduct inspections by qualified personnel, follow manufacturer's guidelines, and use methods capable of determining either a decrease in treated effluent flowrate and/or a decrease in pollutant removal ability.
- When inspections are performed, the following findings typically serve as maintenance triggers:
  - Standing water remains in the vault between rain events, or
  - Bypass occurs during storms smaller than the design storm.
  - If excessive floatables (trash and debris) are present (but no standing water or excessive sedimentation), perform a minor maintenance consisting of gross solids removal, not prefilter media replacement.
  - Additional data collection will be used to create a correlation between pretreatment chamber sediment depth and pre-filter clogging (see *Issues to be Addressed by the Company* section below)

6. Discharges from the MWS - Linear Modular Wetland Stormwater Treatment System units shall not cause or contribute to water quality standards violations in receiving waters.

Applicant: Modular Wetland Systems, Inc.  
Applicant's Address: PO. Box 869  
Oceanside, CA 92054

**Application Documents:**

- *Original Application for Conditional Use Level Designation*, Modular Wetland System, Linear Stormwater Filtration System Modular Wetland Systems, Inc., January 2011
- *Quality Assurance Project Plan: Modular Wetland system – Linear Treatment System performance Monitoring Project*, draft, January 2011.
- *Revised Application for Conditional Use Level Designation*, Modular Wetland System, Linear Stormwater Filtration System Modular Wetland Systems, Inc., May 2011
- *Memorandum: Modular Wetland System-Linear GULD Application Supplementary Data*, April 2014
- *Technical Evaluation Report: Modular Wetland System Stormwater Treatment System Performance Monitoring*, April 2014.

**Applicant's Use Level Request:**

General use level designation as a Basic, Enhanced, and Phosphorus treatment device in accordance with Ecology's Guidance for Evaluating Emerging Stormwater Treatment Technologies Technology Assessment Protocol – Ecology (TAPE) January 2011 Revision.

**Applicant's Performance Claims:**

- The MWS – Linear Modular wetland is capable of removing a minimum of 80-percent of TSS from stormwater with influent concentrations between 100 and 200 mg/l.
- The MWS – Linear Modular wetland is capable of removing a minimum of 50-percent of Total Phosphorus from stormwater with influent concentrations between 0.1 and 0.5 mg/l.
- The MWS – Linear Modular wetland is capable of removing a minimum of 30-percent of dissolved Copper from stormwater with influent concentrations between 0.005 and 0.020 mg/l.
- The MWS – Linear Modular wetland is capable of removing a minimum of 60-percent of dissolved Zinc from stormwater with influent concentrations between 0.02 and 0.30 mg/l.

**Ecology Recommendations:**

- Modular Wetland Systems, Inc. has shown Ecology, through laboratory and field-testing, that the MWS - Linear Modular Wetland Stormwater Treatment System filter system is capable of attaining Ecology's Basic, Total phosphorus, and Enhanced treatment goals.

**Findings of Fact:**Laboratory Testing

The MWS-Linear Modular wetland has the:

- Capability to remove 99 percent of total suspended solids (using Sil-Co-Sil 106) in a quarter-scale model with influent concentrations of 270 mg/L.
- Capability to remove 91 percent of total suspended solids (using Sil-Co-Sil 106) in laboratory conditions with influent concentrations of 84.6 mg/L at a flow rate of 3.0 gpm per square foot of media.
- Capability to remove 93 percent of dissolved Copper in a quarter-scale model with influent concentrations of 0.757 mg/L.
- Capability to remove 79 percent of dissolved Copper in laboratory conditions with influent concentrations of 0.567 mg/L at a flow rate of 3.0 gpm per square foot of media.
- Capability to remove 80.5-percent of dissolved Zinc in a quarter-scale model with influent concentrations of 0.95 mg/L at a flow rate of 3.0 gpm per square foot of media.
- Capability to remove 78-percent of dissolved Zinc in laboratory conditions with influent concentrations of 0.75 mg/L at a flow rate of 3.0 gpm per square foot of media.



## Field Testing

- Modular Wetland Systems, Inc. conducted monitoring of an MWS-Linear (Model # MWS-L-4-13) from April 2012 through May 2013, at a transportation maintenance facility in Portland, Oregon. The manufacturer collected flow-weighted composite samples of the system's influent and effluent during 28 separate storm events. The system treated approximately 75 percent of the runoff from 53.5 inches of rainfall during the monitoring period. The applicant sized the system at 1 gpm/sq ft. (wetland media) and 3gpm/sq ft. (prefilter).
- Influent TSS concentrations for qualifying sampled storm events ranged from 20 to 339 mg/L. Average TSS removal for influent concentrations greater than 100 mg/L (n=7) averaged 85 percent. For influent concentrations in the range of 20-100 mg/L (n=18), the upper 95 percent confidence interval about the mean effluent concentration was 12.8 mg/L.
- Total phosphorus removal for 17 events with influent TP concentrations in the range of 0.1 to 0.5 mg/L averaged 65 percent. A bootstrap estimate of the lower 95 percent confidence limit (LCL95) of the mean total phosphorus reduction was 58 percent.
- The lower 95 percent confidence limit of the mean percent removal was 60.5 percent for dissolved zinc for influent concentrations in the range of 0.02 to 0.3 mg/L (n=11). The lower 95 percent confidence limit of the mean percent removal was 32.5 percent for dissolved copper for influent concentrations in the range of 0.005 to 0.02 mg/L (n=14) at flow rates up to 28 gpm (design flow rate 41 gpm). Laboratory test data augmented the data set, showing dissolved copper removal at the design flow rate of 41 gpm (93 percent reduction in influent dissolved copper of 0.757 mg/L).

## **Issues to be addressed by the Company:**

1. Modular Wetland Systems, Inc. should collect maintenance and inspection data for the first year on all installations in the Northwest in order to assess standard maintenance requirements for various land uses in the region. Modular Wetland Systems, Inc. should use these data to establish required maintenance cycles.
2. Modular Wetland Systems, Inc. should collect pre-treatment chamber sediment depth data for the first year of operation for all installations in the Northwest. Modular Wetland Systems, Inc. will use these data to create a correlation between sediment depth and pre-filter clogging.

## **Technology Description:**

Download at <http://www.modularwetlands.com/>

## **Contact Information:**

Applicant: Zach Kent  
BioClean A Forterra Company.  
398 Vi9a El Centro  
Oceanside, CA 92058  
[zach.kent@forterrabp.com](mailto:zach.kent@forterrabp.com)

Applicant website: <http://www.modularwetlands.com/>

Ecology web link: <http://www.ecy.wa.gov/programs/wg/stormwater/newtech/index.html>

Ecology: Douglas C. Howie, P.E.  
Department of Ecology  
Water Quality Program  
(360) 407-6444  
[douglas.howie@ecy.wa.gov](mailto:douglas.howie@ecy.wa.gov)

**Revision History**

<b>Date</b>	<b>Revision</b>
June 2011	Original use-level-designation document
September 2012	Revised dates for TER and expiration
January 2013	Modified Design Storm Description, added Revision Table, added maintenance discussion, modified format in accordance with Ecology standard
December 2013	Updated name of Applicant
April 2014	Approved GULD designation for Basic, Phosphorus, and Enhanced treatment
December 2015	Updated GULD to document the acceptance of MWS-Linear Modular Wetland installations with or without the inclusion of plants
July 2017	Revised Manufacturer Contact Information (name, address, and email)

# ATTACHMENT 2

## Backup for PDP Hydromodification Control Measures

- Mark this box if this attachment is empty because the project is exempt from PDP hydromodification management requirements.

**Indicate which Items are Included**

Attachment Sequence	Contents	Checklist
<b>Attachment 2A</b>	Hydromodification Management Exhibit (Required)	<input type="checkbox"/> Included See Hydromodification Management Exhibit Checklist.
<b>Attachment 2B</b>	Management of Critical Coarse Sediment Yield Areas (WMAA Exhibit is required, additional analyses are optional)  See Section 6.2 of the BMP Design Manual.	<input type="checkbox"/> Exhibit showing project drainage boundaries marked on WMAA Critical Coarse Sediment Yield Area Map <b>(Required)</b>  Optional analyses for Critical Coarse Sediment Yield Area Determination <ul style="list-style-type: none"> <li><input type="checkbox"/> 6.2.1 Verification of Geomorphic Landscape Units Onsite</li> <li><input type="checkbox"/> 6.2.2 Downstream Systems Sensitivity to Coarse Sediment</li> <li><input type="checkbox"/> 6.2.3 Optional Additional Analysis of Potential Critical Coarse Sediment Yield Areas Onsite</li> </ul>
<b>Attachment 2C</b>	Geomorphic Assessment of Receiving Channels (Optional)  See Section 6.3.4 of the BMP Design Manual.	<input type="checkbox"/> Not performed <input type="checkbox"/> Included <input type="checkbox"/> Submitted as separate stand-alone document
<b>Attachment 2D</b>	Flow Control Facility Design and Structural BMP Drawdown Calculations (Required)  Overflow Design Summary for each Structural BMP  See Chapter 6 and Appendix G of the BMP Design Manual	<input type="checkbox"/> Included <input type="checkbox"/> Submitted as separate stand-alone document

**FOR HYDROMODIFICATION  
MANAGEMENT EXHIBIT SEE  
ATTACHMENT A OF  
HYDROMODIFICATION STUDY IN  
ATTACHMENT 2D**

# **ATTACHMENT 2B**

## **MANAGEMENT OF CRITICAL COARSE SEDIMENT YIELD AREAS**

**LEGEND**

- WMAA CCSYA
- BYPASS WMAA CCSYA
- ONSITE WMAA CCSYA
- TOTAL DRAINAGE AREA TO POC 2

ONSITE CCSYA SUMMARY		
	AREA	% OF SITE
ONSITE CCSYA AREA 1	6441 SF	3.7
TOTAL DRAINAGE AREA TO POC 2	174,893 SF	
3.7% LESS THAN 5% ALLOWANCE THEREFORE ONSITE CCSYA AREA IS ACCOUNTED FOR VIA H.2.1 AVOIDANCE METRICS IN THE 2021 CITY OF CHULA VISTA BMP DESIGN MANUAL		

**BYPASS CCSYA NOTE:**

HILLSLOPE CCSYA WILL BE BYPASSED THE PROJECT SITE AND WILL FLOW INTO A DRAINAGE DITCH TO THE NORTHEAST CORNER OF THE PROJECT. THE DRAINAGE DITCH WILL CONVEY BED SEDIMENT FROM HILLSLOPES TO DOWNSTREAM WATERS BY MAINTAINING A PEAK VELOCITY GREATER THAN OF 3 FEET PER SECOND FOR THE 2-YEAR, 24 HOUR RUNOFF EVENT.

STEP 1 IDENTIFIED THE CCSYA. STEP 2 AVOIDANCE OF THIS HILLSLOPE WAS NOT POSSIBLE. STEP 3 BYPASS OF CCSYA WAS COMPLETED. NO NET IMPACT ANALYSIS IS NOT REQUIRED BY MEETING THE GUIDANCE FOR STEP 3 BYPASS OF HILLSLOPE CCSYA.

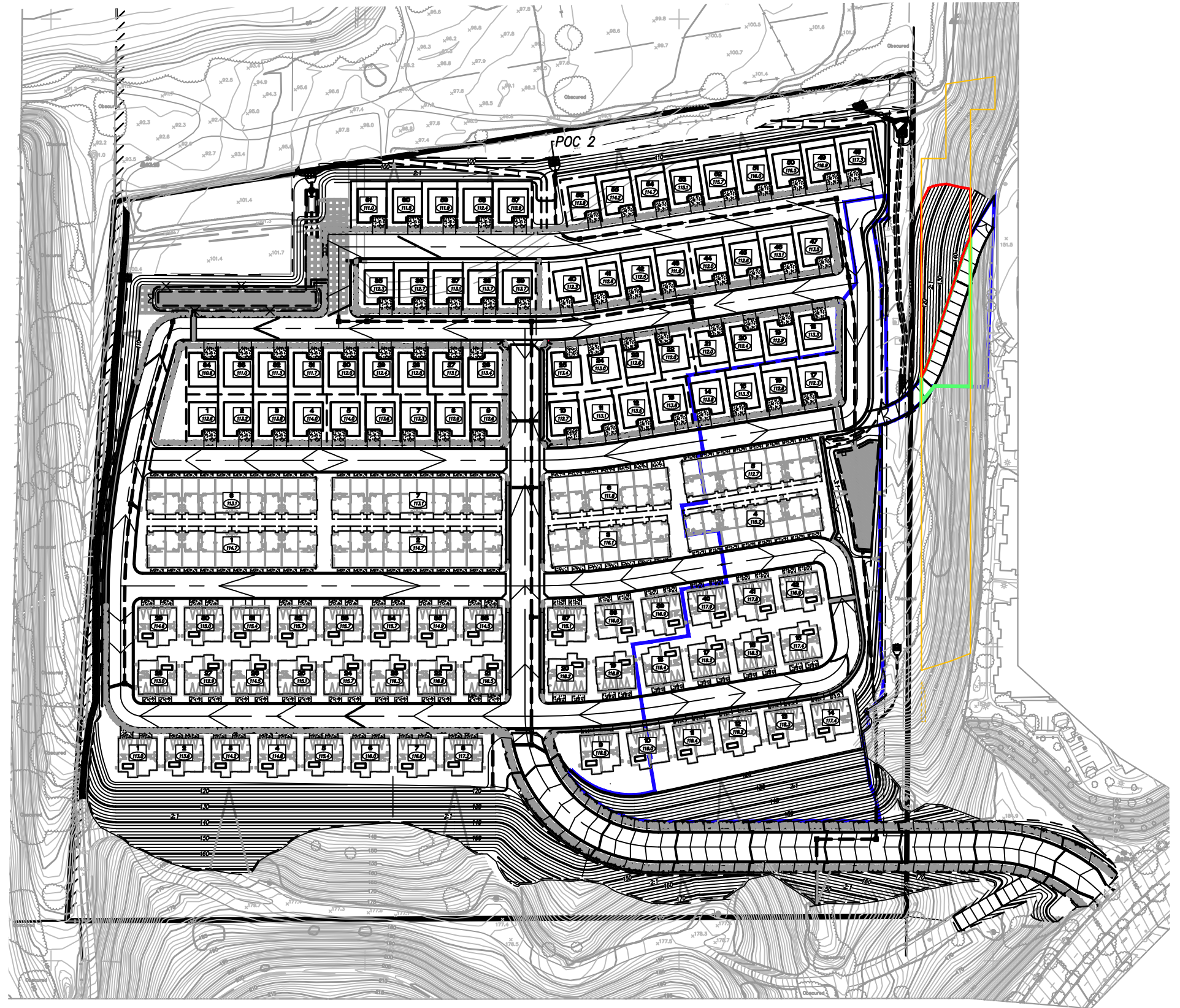

<p>PREPARED BY:</p> <p><b>PROJECT DESIGN CONSULTANTS</b>          Planning   Landscape Architecture   Engineering   Survey</p> <p style="font-size: small;">701 B Street, Suite 800          San Diego, CA 92101          619.238.6771 Tel          619.234.0948 Fax</p>	<p><b>CITY OF CHULA VISTA</b></p> <p><b>NAKANO</b></p> <p><b>Attachment 2B</b>  <b>CCSYA VICINITY MAP</b></p>
	<p>SCALE: 1" = 150'      JOB #: 4409.00      CREATED: 02/09/22</p>

# **ATTACHMENT 2D**

**FLOW CONTROL FACILITY DESIGN  
AND STRUCTURAL BMP DRAWDOWN  
CALCULATIONS**



# Preliminary Hydromodification Management Study

## NAKANO

*City of Chula Vista TM#PCS21-0001,  
City of San Diego PTS 647766*

City of Chula Vista CA  
November 3, 2022

Prepared for:  
TriPointe Homes  
13400 Sabre Springs Parkway, Suite 200  
San Diego, California 92128

Prepared By:



### PROJECT DESIGN CONSULTANTS

Planning | Landscape Architecture | Engineering | Survey

701 B Street, Suite 800  
San Diego, CA 92101  
619.235.6471 Tel  
619.234.0349 Fax

PDC Job No. 4409.02



Prepared by: J. Novoa, PE  
*Under the supervision of*

---

Chelisa Pack, PE RCE 71026  
Registration Expires 06/30/23

## **1. INTRODUCTION**

This report summarizes the preliminary hydromodification design for the Nakano development Project for a Tentative Map (TM) submittal located in the City of Chula Vista, CA. The hydromodification calculations were performed utilizing continuous simulation analysis to size the storm water treatment and control facilities. Storm Water Management Model (SWMM) version 5.1 distributed by USEPA is the basis of both existing and proposed conditions modeling within this report. The biofiltration basin/hydromodification basin sizing and link configuration with the specialized outlet configuration ensures compliance with the Hydromodification Management Plan (HMP) requirements from the San Diego Regional Water Quality Control Board (SDRWQCB).

## **2. HYDROMODIFICATION MODELING OVERVIEW**

### **2.1 Model Description**

PCSWMM is a proprietary software which utilizes the EPA's Stormwater Management Model (SWMM) as its computational engine, while providing added processing and analytical capabilities to streamline design. PCSWMM is essentially a user-friendly shell for SWMM that allows rapid development and analysis of SWMM models.

PCSWMM was employed for this study based on the ability to efficiently create, edit and compare models, perform detention routing with the same software, and moreover, due to the tendency for SWMM to produce results that have been found to more accurately represent San Diego area watersheds than the alternative San Diego Hydrology Model (SDHM).

SWMM is a semi-distributed hydrologic and hydraulic modeling software that simulates the rainfall-runoff response of a watershed based on linear-reservoir overland flow routing. This overland flow routine accounts for the connectedness of pervious, impervious, and Low Impact Development (LID) BMPs to the drainage system. LID BMPs are represented with a module in SWMM that simulates the water balance through standard LID BMP components, accounting for soil percolation, evapotranspiration, underdrain outflow, various media layer storage and subgrade infiltration (if applicable). These controls provide a wide range of customizability between the various associated parameters and the ability to route underdrain or overflow to other SWMM elements, like Storages Nodes and conduits to represent almost any conceivable LID system.

The outflow from these LID controls, storage components or watersheds is translated into the hydraulic component of the model that utilizes energy and momentum principles to determine flow through conduits, orifices and other structures. The hydraulics may be computed based on either the kinematic or dynamic-wave equations. In this study the former was used because there was no need to take downstream hydraulic grade line effects into consideration.

## **2.2 Hydromodification Criteria**

The San Diego Regional Water Quality Control Board (SDRWQCB) requires the exceedance duration of post-developed flow rates be maintained to within 10% of the pre-developed flow durations. This must occur for flow frequencies ranging from a fraction of the 2-year flow (Q2) to the 10-year flow (Q10). These flow frequency values may be calculated directly from SWMM statistics or estimated based on accepted USGS regression equations. These equations estimate flows based on a correlation with watershed area and the mean annual rainfall developed for the region. For this project the SWMM output was used because of the exceedingly small values calculated by regression equations, which were developed with data from significantly larger watersheds.

The fraction of the Q2 that must be controlled is dependent on the relative erodibility of the channel being discharged to, categorized as either High, Medium, or Low susceptibility. By default it is assumed that all channels have a High susceptibility, and that therefore the low flow threshold of 0.1 of the Q2 must be controlled. A Geomorphic Assessment of Receiving Channels may be performed to indicate whether the channel erosion susceptibility can be categorized as Medium or Low, allowing control to 0.3 or 0.5 of the Q2, respectively.

The low-flow threshold used in the analysis for Nakano project for POCs 1 and 2 are the default 0.1Q2 low-flow threshold, as determined as “high susceptibility”. A geomorphic assessment report may be completed in the future to achieve a low or medium susceptibility, but is not completed as this time.

## **2.3 Model Development**

The inputs required for a SWMM model include rainfall, evapotranspiration rates, watershed characteristics and BMP configurations. The sources for some of these parameters are provided in Table 1 below.

**Table 1: Hydrology Criteria**

Rain Gage	‘Bonita’ – from Project Clean Water website
Evapotranspiration	Daily E-T Rates taken from Table G.1-1 in the <u>City of Chula Vista BMP Design Manual</u> based on location in Zone 6 of California irrigation Management Information System “Reference Evapotranspiration Zones”
Overland Flow Path Length	Based on available digital topographic data for pre-development conditions and proposed grading plan for post-project conditions.
Soils/Green-Ampt Parameters	Values for Hydrologic Soil Group ‘C and D’ taken from Table G.1-4 in the <u>City of San Diego BMP Design Manual</u> . A 25% reduction is applied whenever native soils are compacted.

The drainage area to each point of compliance (POC) was delineated with the project boundary plus adjacent land that drain through the site for both existing and proposed conditions. For the proposed model this drainage area has been broken up into the contributing drainage management (DMA) areas that drain to BMPs. DMAs 1 and 3 flow to POC 1 and outlet via sheet to the flow north. POC 2 contains flow from DMA 2 and outlets east of POC 1 via sheet flow north as well. See the Storm Water Quality Management Plan (SWQMP) for more information regarding the pollutant control strategy and DMAs.

The overland flow path lengths were drawn from a visual inspection of the watershed contours, extending from the upper ridge to the apparent flow path, perpendicular to the contours. The percent imperviousness was calculated based on the estimated imperviousness in the site plan to develop the same values used to calculate the Design Capture Volume provided in Attachment 1e of the SWQMP.

### **3. Modeling for Hydromodification Compliance**

The pre-developed conditions for the site were modelled based on the existing topography and landcover with zero imperviousness. For the post-developed condition, the proposed site footprint was represented as an equivalent imperviousness and a short overland flow path length typical of urban drainage systems. The lined biofiltration basins were modelled by coupling the bioretention LID component to properly represent the media and underdrain, with the storage component to

represent the basin surface storage. The parameters utilized for the biofiltration parameters were based on the published values in the City of Chula Vista BMP Design Manual. The basins outlet to new proposed private storm drains that discharges and sheet flow north just before Otay River.

It was determined that this suite of BMPs would be sufficient to provide flow control with the storage depths and outlet size provided herein based on the SWMM modeling results. The Status Report SWMM output files for the existing condition models are provided in Attachment D.

### 3.1 Flow Frequency Analysis

The SWMM statistics calculator was used to determine the pre-developed and post developed flow rates for the 2, 5, and 10-year recurrence intervals. These are provided below with the resultant low flow threshold. The SWMM output used to calculate these values is provided in Attachment E.

The low-flow threshold used in the analysis for Nakano project for POCs 1 and 2 are the default 0.1Q2 low-flow threshold, as determined as “high susceptibility”.

**Table 2 – Pre-Developed and Post-Mitigated Flows for POC 1 (BMP Basin 1 & BMP 3 MWS & Vault)**

Return Period	Pre-project Qpeak (cfs)	Post-project - Mitigated Q (cfs)
LF = 0.1xQ2	0.326	0.327
2-year	3.263	3.274
5-year	4.477	4.516
10-year	5.760	5.804

**Table 3 – Pre-Developed and Post-Mitigated Flows for POC 2 (BMP Basin 2)**

Return Period	Pre-project Qpeak (cfs)	Post-project - Mitigated Q (cfs)
LF = 0.1xQ2	0.072	0.028
2-year	0.720	0.277
5-year	1.054	0.945
10-year	1.276	1.257

### 3.2 Biofiltration Basins

The basins are composed of above ground storage as well as biofiltration media. These components were represented as an LID control (“Bio-retention cell”) in series with a storage node as simulated in SWMM. The module allows the user to represent the various stages of a biofiltration basin including ponding, media, and gravel storage above and below the underdrain. These layer depths were assigned per the design developed for pollutant control as shown in Table 4 and the parameter values were assigned with the standard values taken from Table G.1-7 in the BMP Design Manual (with some refinement). The underdrain is offset to allow for the dead storage needed. The drain coefficients are calculated based on media infiltration of 5 in/hr and basin layer depth and listed in Table 4. Drain coefficient calculation is based on C factor calculation equation in the BMP Design Manual (Page G-27).

$$C = c_g \left( \frac{605}{A_{LID}} \right) \left( \frac{\pi D^2}{8} \right) \sqrt{\frac{g}{6}}$$

where,

- cg is the orifice discharge coefficient, typically 0.60-0.65 for thin walled plates and higher for thicker walls;
- ALID is the cumulative footprint area (ft<sup>2</sup>) of all LID controls;
- D is the underdrain orifice diameter (in); and
- g is the gravitational constant (32.2 ft/s<sup>2</sup>).

**Table 4 – Biofiltration Model Summary**

Biofiltration BMP #	Surface Area (sf)	Layer Depth			Underdrain Orifice (in)	Drain Coefficient
		Ponding (in)	Soil (in)	Gravel Storage (in)		
1	3,608	6	24	12	1	0.0908
2	4,523	6	24	12	0.8	0.0593
Media and storage parameters taken from Table G.1-7 in BMP Design Manual, including media infiltration = 5 in/hr						

To control the flows with this configuration, except for underdrain orifices, a series of flow orifices were connected between the biofiltration basin storage node connected to the point of compliance. The orifice design is summarized in Table 5. Additional screenshots of orifices and weirs are provided in Attachment B. The offset elevation of the above ground orifices are taken from the bottom of the storage node in PCSWMM which is the elevation above the water quality ponding depth, typically 0.75’ above the basin bottom (0.5’ of WQ ponding and 0.25’ of mulch).

**Table 5 – Biofiltration Orifice Design**

Biofiltration BMP #	Low Flow Orifice		Overflow Weir	
	Dia. (in)	Offset (ft)	Type	Offset (ft)
1	0.8	0.0	Modified G-3 Riser	0.5
2	1	0.0	Modified G-3 Riser	1

### 3.3 Detention/Hydromodification Underground Vault

A multi-use underground storage vault is utilized for DMA 3. The underground vault will detain flows for the 100-year storm event, provide storage for hydromodification requirements and is also utilized for storage upstream of a modular wetland unit for water quality treatment purposes. The underground vault consists of a 5’ depth and approx. 12,736 bottom footprint, which contains a weir wall within the vault. See below for the vault characteristics and parameters.

**Table 6 –Underground Vault Storage Summary**

Hydromod BMP #	Bottom Footprint (sf)	Depth (ft)
BMP3	12,736	5

BMP #3		
Riser Structure Parameters	Size	Height (ft)
	2.2" orifice (within MWS)* Weir Wall L=8'	0.0 4.5

\*One single orifice was modeled in the SWMM model. The MWS Unit utilizes two 1.48" orifices. The equivalent flow out was calculated to be the same for the single orifice and two orifices, so they act similarly.

### 3.4 Flow Duration Curves for Hydromodification Compliance

The pre and post developed flow duration exceedance curves were developed for the hourly flow data using an automatic partial duration series calculator in PCSWMM. These curves are graphed over the flow ranges listed in Tables 2 and 3 and are provided in Attachment F. In all cases the duration of post developed flows are brought to well within that of the pre developed flows within the low flow and high flow thresholds, indicating that the suite of BMPs will provide the flow attenuation required for compliance.

## 4.0 SUMMARY

The predeveloped conditions of the Nakano project were modelled in SWMM to determine a baseline of flow durations that would need to be controlled in the post-developed conditions. The proposed development was also modelled in SWMM with biofiltration basins with storage as well as detention/hydromodification vault. Based on the SWMM model results for this study it is determined that the combination of two biofiltration basin and a hydromodification vault LID BMPs will be able to satisfy the hydromodification criteria. This study is intended to demonstrate that these controls as sized are capable of providing hydromodification compliance for the project.



## Attachments

- A – Hydromodification Management Exhibit
- B – SWMM Model w/ Subcatchment Schematics
- C – SWMM Output – Existing Condition
- D – SWMM Output – Proposed Conditions
- E – Flow Frequency Statistical Analysis results
- F – Flow Duration Curves

**ATTACHMENT A**

**Hydromodification Management Exhibit**

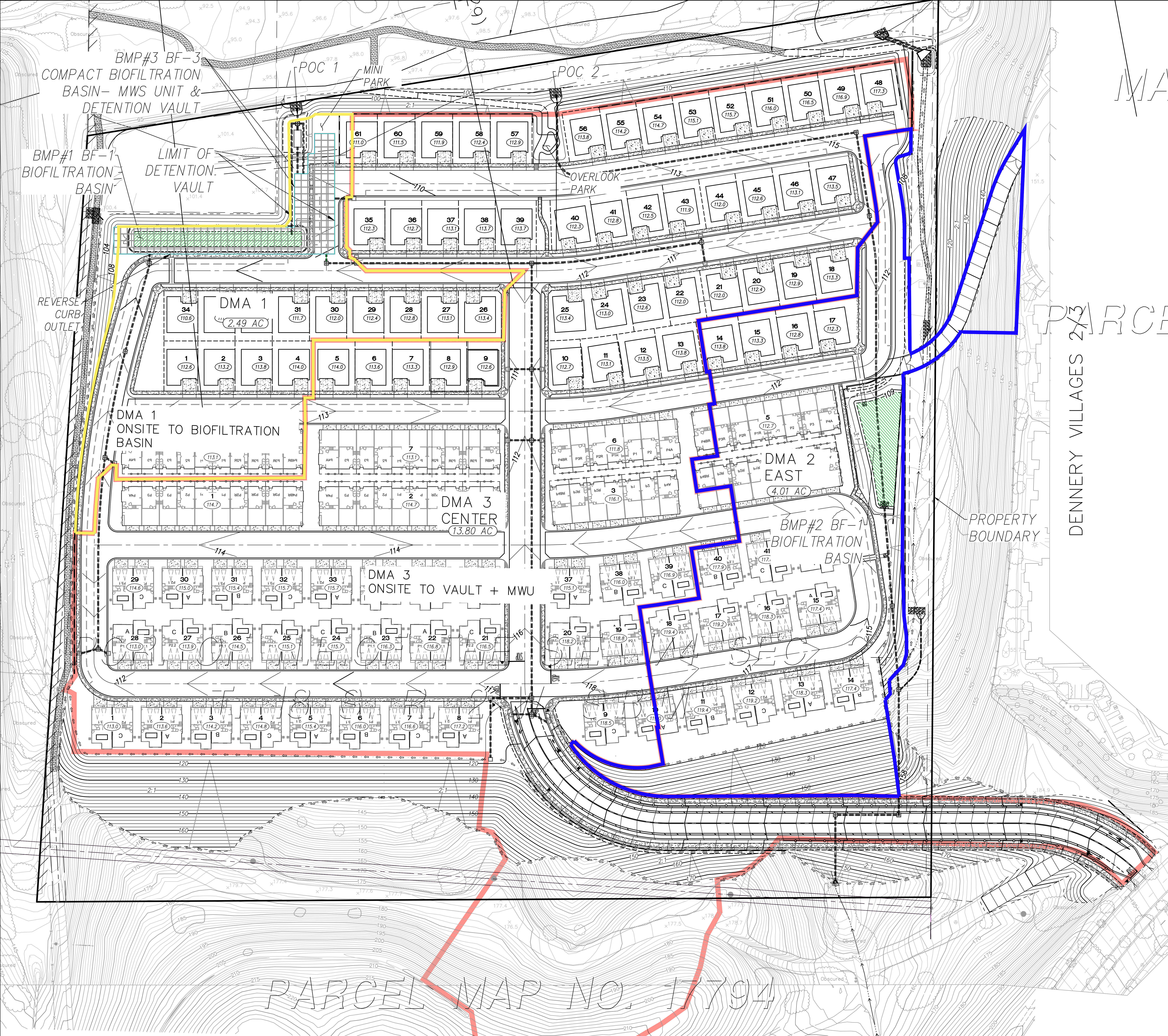

LEGEND

- DRAINAGE MANAGEMENT AREA #1
- DRAINAGE MANAGEMENT AREA #2
- DRAINAGE MANAGEMENT AREA #3
- BIOFILTRATION BASIN
- DRAINAGE FLOWPATH
- DETENTION/HYDROMODIFICATION VAULT

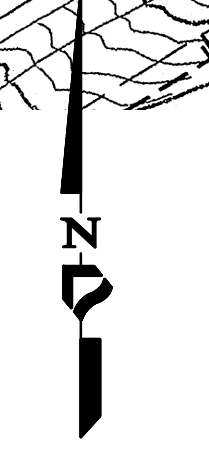
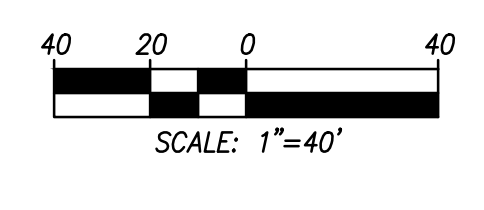

SCALE: 1"=40"  
 JOB #: 4409.02  
 CREATED: 3/11/20

PREPARED BY:  
  
**PROJECT DESIGN CONSULTANTS**  
 Planning | Landscape Architecture | Environmental | Engineering | Survey  
 701 B Street, Suite 800 San Diego, CA 92101  
 619.235.6471 Tel 619.234.0349 Fax

**CITY OF CHULA VISTA**  
**NAKANO**  
 HYDROMODIFICATION EXHIBIT  
 PROPOSED CONDITIONS  
 EXHIBIT A

P:\14409\Reports-4409-02-Nakano\Entitlement\Hydromod\ER1\4409.02\_Hydromod\_EA01.dwg 11/21/2022 8:16:02 AM

**ATTACHMENT B**

**SWMM Model with  
Sub-catchment Parameters and Schematic**

## Existing Conditions

### POC 1

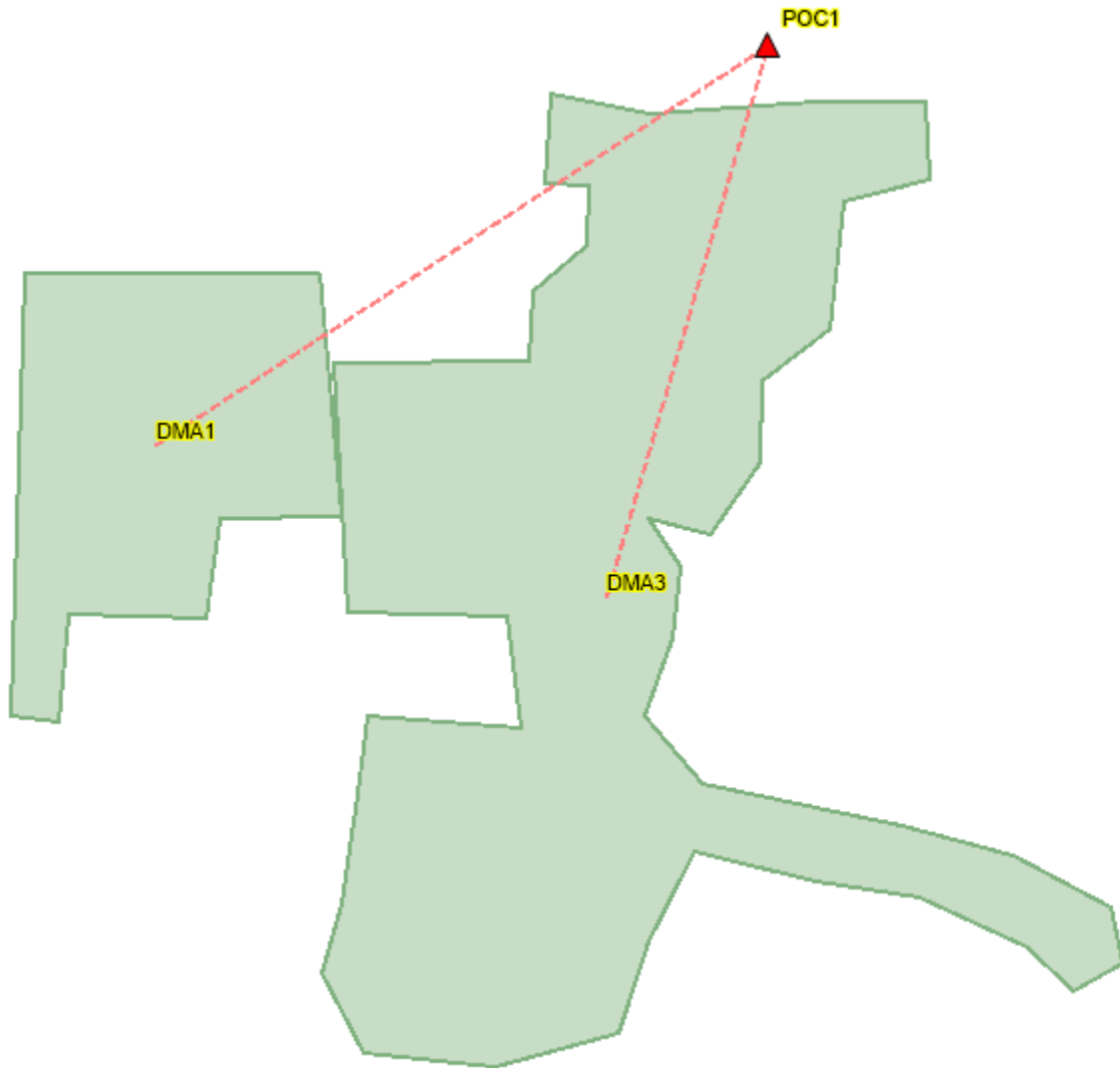

Name	Rain Gage	Outlet	Area (ac)	Width (ft)	Flow Length (ft)	Slope (%)	Imperv. (%)	N Imperv	N Perv	Dstore Imperv (in)	Dstore Perv (in)	Infiltration Method	Suction Head (in)	Conductivity (in/hr)	Initial Deficit (frac.)
▶ DMA1	Bonita	POC1	2.49	520	208.5...	5	0	0.012	0.15	0.05	0.1	GREEN_AMPT ▾	6	0.1	0.31
DMA3	Bonita	POC1	13.8	631	952.6...	15	0	0.012	0.15	0.05	0.1	GREEN_AMPT ▾	6	0.1	0.31

## POC 2

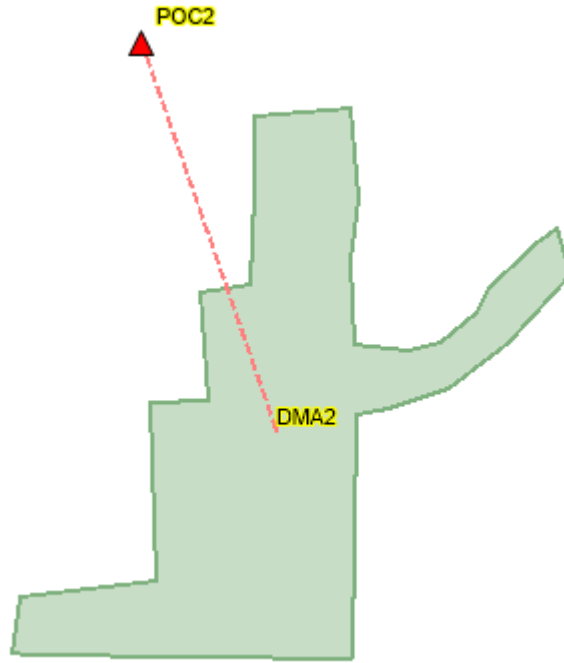

Name	Rain Gage	Outlet	Area (ac)	Width (ft)	Flow Length (ft)	Slope (%)	Imperv. (%)	N Imperv	N Perv	Dstore Imperv (in)	Dstore Perv (in)	Zero Imperv (%)	Subarea Routing	Percent Routed (%)	Suction Head (in)	Conductivity (in/hr)	Initial Deficit (frac.)
▶ DMA2	Bonita	POC2	4.01	342	510.747	9.5	0	0.012	0.15	0.05	0.1	25	OUTLET	100	6	0.1	0.31

## Proposed Conditions

### POC 1

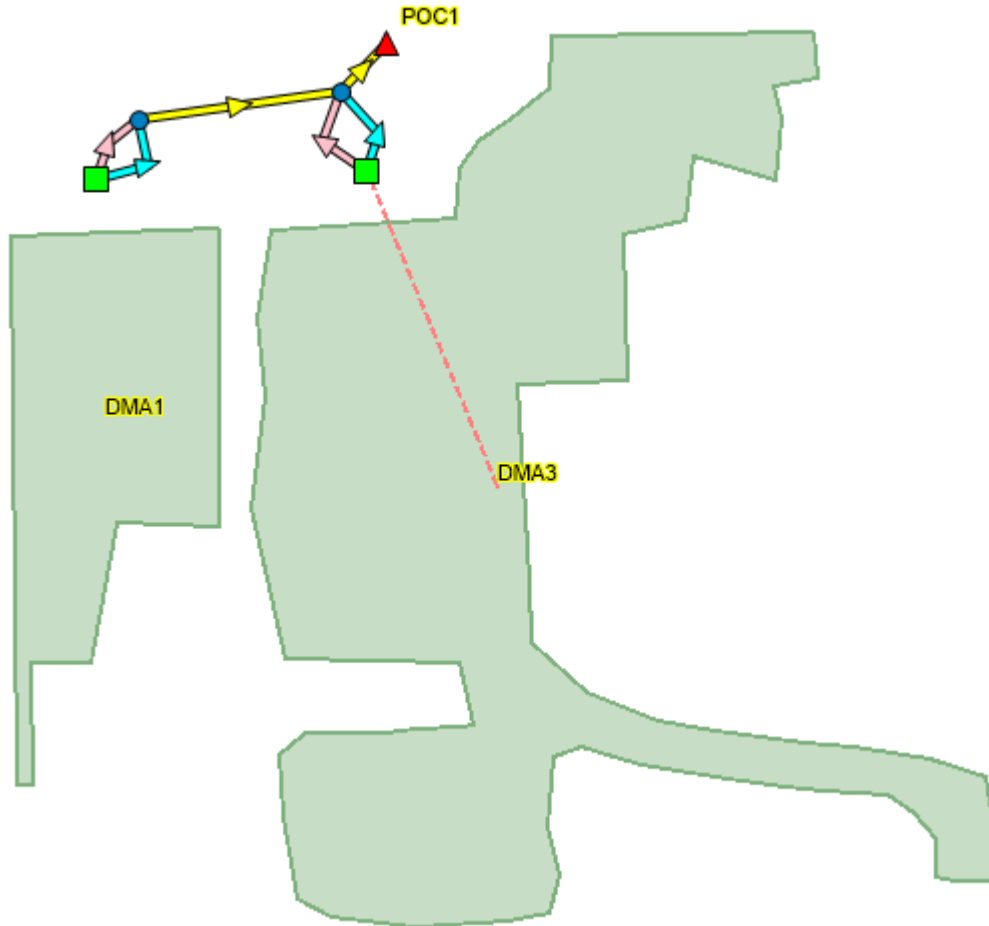

Name	Rain Gage	Outlet	Area (ac)	Width (ft)	Flow Length (ft)	Slope (%)	Imperv. (%)	N Imperv	N Perv	Dstore Imperv (in)	Dstore Perv (in)	LID Controls	LID Names	Infiltration Method	Suction Head (in)	Conductivity (in/hr)	Initial Deficit (frac.)
▶ DMA1	Bonita	SU1	2.49	520	208.585	3.5	69	0.012	0.15	0.05	0.1	1	BMP1	GREEN_AMPT	6	0.075	0.31
DMA3	Bonita	SU2	13.8	420	1431.257	8.2	64.8	0.012	0.15	0.05	0.1	0		GREEN_AMPT	6	0.075	0.31

## Basin 1 PCSWMM LID & Orifice Parameters

**LID Control Editor** ? X

LID controls: **BMP1**

Name: BMP1

LID type: Bio-Retention Cell

Surface | Soil | Storage | Underdrain | Pollutant Removals

Berm height (in) 6

Vegetation volume (fraction) 0.0

Surface roughness (Manning's n) 0.1

Surface slope (percent) 1.0

Add Del OK Cancel

**LID Control Editor** ? X

LID controls: **BMP1**

Name: BMP1

LID type: Bio-Retention Cell

Surface | Soil | Storage | Underdrain | Pollutant Removals

Thickness (in) 24

Porosity (volume fraction) 4

Field capacity (volume fraction) 2

Willing point (volume fraction) 0.1

Conductivity (in/hr) 5

Conductivity slope 5

Suction head (in) 1.5

Add Del OK Cancel

**LID Control Editor** ? X

LID controls: **BMP1**

Name: BMP1

LID type: Bio-Retention Cell

Surface | Soil | Storage | Underdrain | Pollutant Removals

Thickness (in) 12

Void ratio (voids/solids) .67

Seepage rate (in/hr) 0

Clogging factor 0

Add Del OK Cancel

**LID Control Editor** ? X

LID controls: **BMP1**

Name: BMP1

LID type: Bio-Retention Cell

Surface | Soil | Storage | Underdrain | Pollutant Removals

Drain coefficient (in/hr) .0908

Drain exponent 0.5

Drain offset height (in) 3

Open level (in) 0

Closed level (in) 0

Control curve

Note: Use a drain coefficient of 0 if the LID unit has no underdrain.

Add Del OK Cancel

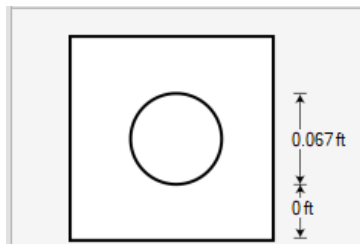

Orifice: OR2

Attributes	
Name	OR2
Inlet Node	SU1
Outlet Node	J2
Description	
Tag	
Type	SIDE
Cross-Section	CIRCULAR
Height (ft)	0.067
Width (ft)	0
Inlet Offset (ft)	0
Discharge Coeff.	0.6
Flap Gate	NO
Time to Open/Clos	0
Control Rules	NO

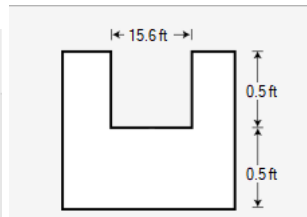

Weir: W2

Attributes	
Name	W2
Inlet Node	SU1
Outlet Node	J2
Description	
Tag	
Type	TRANSVERSE
Height (ft)	0.5
Length (ft)	15.6
Side Slope (ft/ft)	0
Inlet Offset (ft)	0.5
Discharge Coeff. (C)	3
Flap Gate	NO
End Contractions	0
End Coeff. (CFS)	0
Can Surcharge	YES
Coeff. Curve	
Road Width (ft)	0
Road Surface	PAVED
Control Rules	NO



## Vault PCSWMM Orifice Parameters

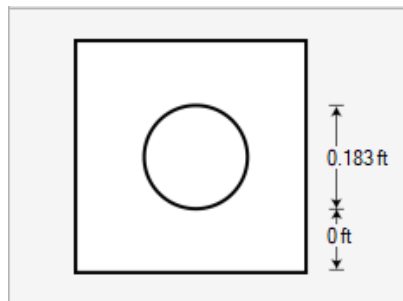
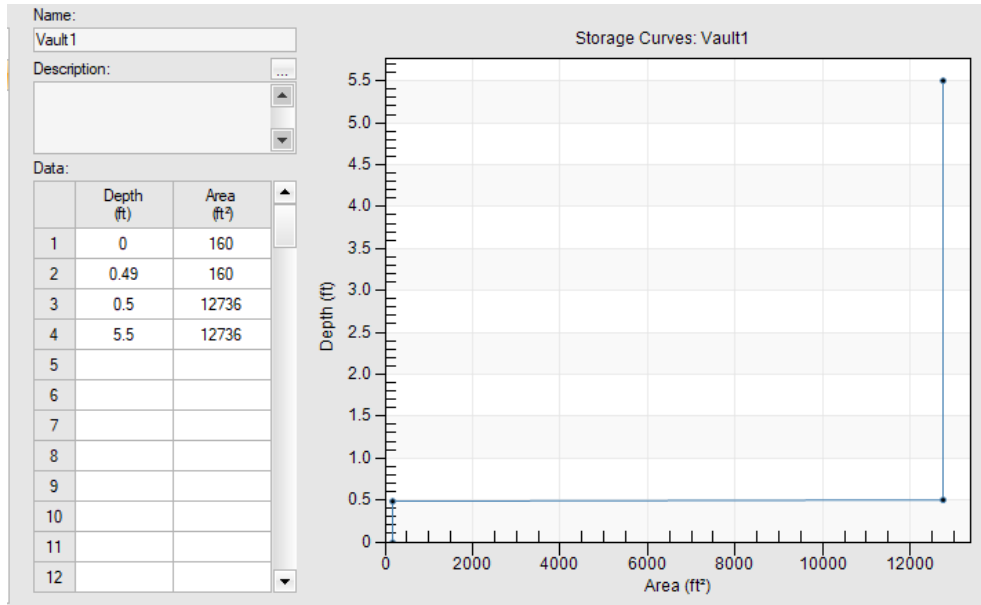

Orifice: OR1

Attributes	
Name	OR1
Inlet Node	SU2
Outlet Node	J1
Description	
Tag	
Type	SIDE
Cross-Section	CIRCULAR
Height (ft)	0.183
Width (ft)	0
Inlet Offset (ft)	0
Discharge Coeff.	0.6
Flap Gate	NO
Time to Open/Close	0
Control Rules	NO

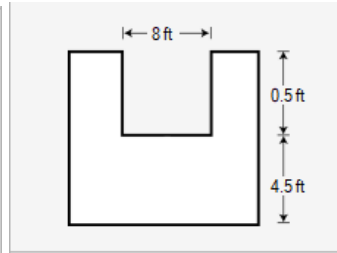

Weir: W1

Attributes	
Name	W1
Inlet Node	SU2
Outlet Node	J1
Description	
Tag	
Type	TRANSVERSE
Height (ft)	0.5
Length (ft)	8
Side Slope (ft./ft.)	0
Inlet Offset (ft)	4.5
Discharge Coeff. (C)	3
Flap Gate	NO
End Contractions	0
End Coeff. (CFS)	0
Can Surcharge	YES
Coeff. Curve	
Road Width (ft)	0
Road Surface	PAVED
Control Rules	NO

## POC 2

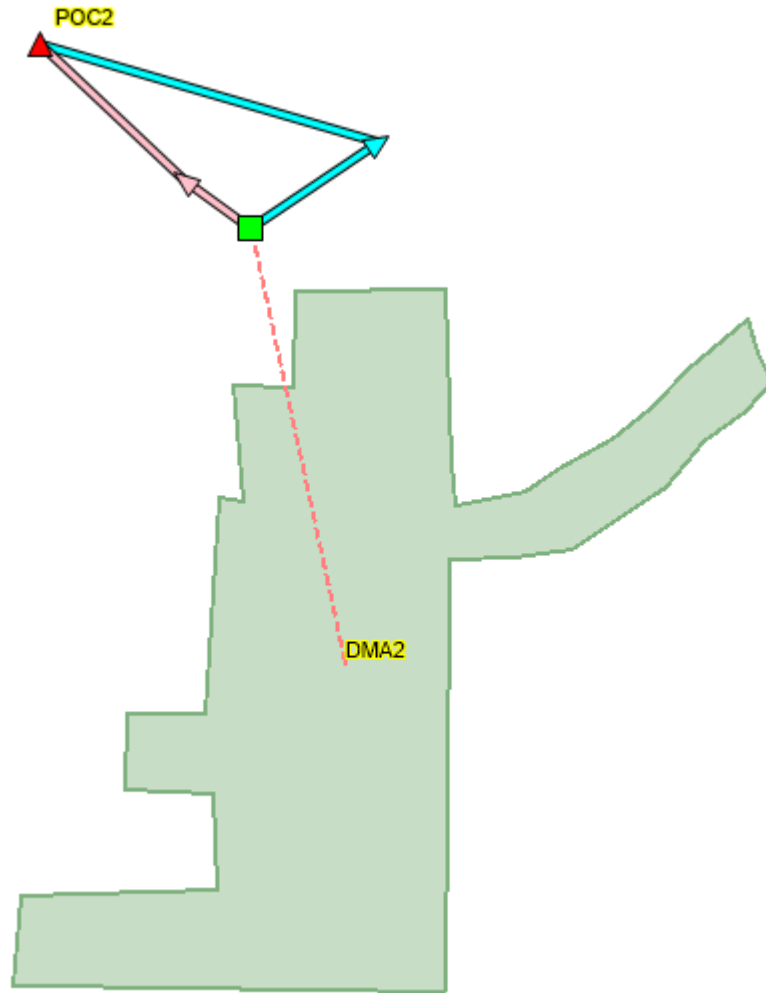

Name	Rain Gage	Outlet	Area (ac)	Width (ft)	Flow Length (ft)	Slope (%)	Imperv. (%)	N Imperv	N Perv	Dstore Imperv (in)	Dstore Perv (in)	Zero Imperv (%)	LID Controls	LID Names	Suction Head (in)	Conductivity (in/hr)	Initial Deficit (frac.)
▶ DMA2	Bonita	SU1	4.01	329	530.929	5	58	0.012	0.15	0.05	0.1	25	1	BMP2	6	0.075	0.31

## Basin 2 PCSWMM LID & Orifice Parameters

**LID Control Editor**

LID controls: BMP2

Name: BMP2

LID type: Bio-Retention Cell

Surface | Soil | Storage | Underdrain | Pollutant Removals

Berm height (in) 12

Vegetation volume (fraction) 0.0

Surface roughness (Manning's n) 0

Surface slope (percent) 0

Add Del QK Cancel

**LID Control Editor**

LID controls: BMP2

Name: BMP2

LID type: Bio-Retention Cell

Surface | Soil | Storage | Underdrain | Pollutant Removals

Thickness (in) 24

Porosity (volume fraction) .4

Field capacity (volume fraction) .2

Wilting point (volume fraction) 0.1

Conductivity (in/hr) 5

Conductivity slope 5

Suction head (in) 1.5

Add Del QK Cancel

**LID Control Editor**

LID controls: BMP2

Name: BMP2

LID type: Bio-Retention Cell

Surface | Soil | Storage | Underdrain | Pollutant Removals

Thickness (in) 12

Void ratio (voids/solids) .67

Seepage rate (in/hr) 0

Clogging factor 0

Add Del QK Cancel

**LID Control Editor**

LID controls: BMP2

Name: BMP2

LID type: Bio-Retention Cell

Surface | Soil | Storage | Underdrain | Pollutant Removals

Drain coefficient (in/hr) .0593

Drain exponent 0.5

Drain offset height (in) 3

Open level (in) 0

Closed level (in) 0

Control curve

Note: Use a drain coefficient of 0 if the LID unit has no underdrain.

Add Del QK Cancel

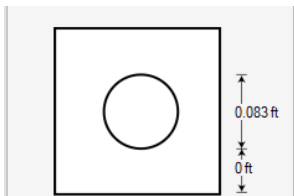

Orifice: OR2

Attributes	
Name	OR2
Inlet Node	SU1
Outlet Node	POC2
Description	
Tag	
Type	SIDE
Cross-Section	CIRCULAR
Height (ft)	0.083
Width (ft)	0
Inlet Offset (ft)	0
Discharge Coeff.	0.65
Flap Gate	NO
Time to Open/Clos	0
Control Rules	NO

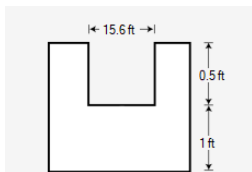

Weir: W1

Attributes	
Name	W1
Inlet Node	SU1
Outlet Node	POC2
Description	
Tag	
Type	TRANSVERSE
Height (ft)	0.5
Length (ft)	15.6
Side Slope (ft/ft)	0
Inlet Offset (ft)	1
Discharge Coeff. (C)	3.33
Flap Gate	NO
End Contractions	0
End Coeff. (CFS)	0
Can Surcharge	YES
Coeff. Curve	
Road Width (ft)	0
Road Surface	PAVED
Control Rules	NO

Raingage Editor

Rain Gages Radar Rainfall

Raingages:  
Bonita

Properties:

Attributes	
Name	Bonita
X-Coordinate	2645.108
Y-Coordinate	8490.879
Description	
Tag	
Rain Format	VOLUME
Time Interval	1:00
Snow Catch Factor	1.0
Data Source	TIMESERIES
Series Name	Bonita

**Name**  
User-assigned name of rain gage.

Plot data file time series

Add Del

Bonita

Rainfall (in)

Date/Time

Design Storm Creator... QK Cancel

**ATTACHMENT C**

**SWMM Output – Existing Conditions**

EPA STORM WATER MANAGEMENT MODEL - VERSION 5.1 (Build 5.1.015)

-----  
 Pre Condition Nakano POC 1-DMA 1&3

\*\*\*\*\*  
 NOTE: The summary statistics displayed in this report are based on results found at every computational time step, not just on results from each reporting time step.  
 \*\*\*\*\*

\*\*\*\*\*  
 Analysis Options  
 \*\*\*\*\*

Flow Units ..... CFS  
 Process Models:  
 Rainfall/Runoff ..... YES  
 RDII ..... NO  
 Snowmelt ..... NO  
 Groundwater ..... NO  
 Flow Routing ..... NO  
 Water Quality ..... NO  
 Infiltration Method ..... GREEN\_AMPT  
 Starting Date ..... 10/03/1970 05:00:00  
 Ending Date ..... 05/25/2008 22:00:00  
 Antecedent Dry Days ..... 0.0  
 Report Time Step ..... 01:00:00  
 Wet Time Step ..... 00:15:00  
 Dry Time Step ..... 00:15:00

	Volume acre-feet	Depth inches
Runoff Quantity Continuity	-----	-----
Total Precipitation .....	460.288	339.070
Evaporation Loss .....	2.974	2.191
Infiltration Loss .....	442.120	325.687
Surface Runoff .....	15.795	11.635
Final Storage .....	0.000	0.000
Continuity Error (%) .....	-0.131	

	Volume acre-feet	Volume 10 <sup>6</sup> gal
Flow Routing Continuity	-----	-----
Dry Weather Inflow .....	0.000	0.000
Wet Weather Inflow .....	15.795	5.147
Groundwater Inflow .....	0.000	0.000
RDII Inflow .....	0.000	0.000
External Inflow .....	0.000	0.000
External Outflow .....	15.795	5.147
Flooding Loss .....	0.000	0.000
Evaporation Loss .....	0.000	0.000
Exfiltration Loss .....	0.000	0.000
Initial Stored Volume .....	0.000	0.000
Final Stored Volume .....	0.000	0.000
Continuity Error (%) .....	0.000	

\*\*\*\*\*  
 Subcatchment Runoff Summary  
 \*\*\*\*\*

Subcatchment	Total Precip in	Total Runon in	Total Evap in	Total Infil in	Imperv Runoff in	Perv Runoff in	Total Runoff in	Total Runoff 10 <sup>6</sup> gal	Peak Runoff CFS	Runoff Coeff
DMA1	339.07	0.00	2.11	323.95	0.00	13.63	13.63	0.92	2.41	0.040
DMA3	339.07	0.00	2.20	326.00	0.00	11.28	11.28	4.23	11.46	0.033

Analysis begun on: Thu Jun 16 11:03:51 2022  
 Analysis ended on: Thu Jun 16 11:04:04 2022  
 Total elapsed time: 00:00:13

EPA STORM WATER MANAGEMENT MODEL - VERSION 5.1 (Build 5.1.015)

-----  
 Pre Condition Nakano POC 2- DMA 2

\*\*\*\*\*  
 NOTE: The summary statistics displayed in this report are based on results found at every computational time step, not just on results from each reporting time step.  
 \*\*\*\*\*

\*\*\*\*\*  
 Analysis Options

\*\*\*\*\*  
 Flow Units ..... CFS  
 Process Models:  
 Rainfall/Runoff ..... YES  
 RDII ..... NO  
 Snowmelt ..... NO  
 Groundwater ..... NO  
 Flow Routing ..... NO  
 Water Quality ..... NO  
 Infiltration Method ..... GREEN\_AMPT  
 Starting Date ..... 10/03/1970 05:00:00  
 Ending Date ..... 05/25/2008 22:00:00  
 Antecedent Dry Days ..... 0.0  
 Report Time Step ..... 01:00:00  
 Wet Time Step ..... 00:15:00  
 Dry Time Step ..... 00:15:00

	Volume acre-feet	Depth inches
*****		
Runoff Quantity Continuity	-----	-----
*****		
Total Precipitation .....	113.306	339.070
Evaporation Loss .....	0.725	2.169
Infiltration Loss .....	108.638	325.102
Surface Runoff .....	4.106	12.288
Final Storage .....	0.000	0.000
Continuity Error (%) .....	-0.144	

	Volume acre-feet	Volume 10 <sup>6</sup> gal
*****		
Flow Routing Continuity	-----	-----
*****		
Dry Weather Inflow .....	0.000	0.000
Wet Weather Inflow .....	4.106	1.338
Groundwater Inflow .....	0.000	0.000
RDII Inflow .....	0.000	0.000
External Inflow .....	0.000	0.000
External Outflow .....	4.106	1.338
Flooding Loss .....	0.000	0.000
Evaporation Loss .....	0.000	0.000
Exfiltration Loss .....	0.000	0.000
Initial Stored Volume .....	0.000	0.000
Final Stored Volume .....	0.000	0.000
Continuity Error (%) .....	0.000	

\*\*\*\*\*  
 Subcatchment Runoff Summary  
 \*\*\*\*\*

Subcatchment	Total Precip in	Total Runon in	Total Evap in	Total Infil in	Imperv Runoff in	Perv Runoff in	Total Runoff in	Total Runoff 10 <sup>6</sup> gal	Peak Runoff CFS	Runoff Coeff
DMA2	339.07	0.00	2.17	325.10	0.00	12.29	12.29	1.34	3.64	0.036

Analysis begun on: Thu Jun 16 10:50:43 2022  
 Analysis ended on: Thu Jun 16 10:50:55 2022  
 Total elapsed time: 00:00:12

**ATTACHMENT D**

**SWMM Output – Proposed Conditions**



-----  
 Post Condition Nakano POC 1- DMA 1&3

\*\*\*\*\*  
 NOTE: The summary statistics displayed in this report are based on results found at every computational time step, not just on results from each reporting time step.  
 \*\*\*\*\*

\*\*\*\*\*  
 Analysis Options

\*\*\*\*\*  
 Flow Units ..... CFS  
 Process Models:  
   Rainfall/Runoff ..... YES  
   RDII ..... NO  
   Snowmelt ..... NO  
   Groundwater ..... NO  
   Flow Routing ..... YES  
   Ponding Allowed ..... NO  
   Water Quality ..... NO  
 Infiltration Method ..... GREEN\_AMPT  
 Flow Routing Method ..... KINWAVE  
 Starting Date ..... 10/03/1970 05:00:00  
 Ending Date ..... 05/25/2008 22:00:00  
 Antecedent Dry Days ..... 0.0  
 Report Time Step ..... 01:00:00  
 Wet Time Step ..... 00:15:00  
 Dry Time Step ..... 00:15:00  
 Routing Time Step ..... 15.00 sec

	Volume acre-feet	Depth inches
Runoff Quantity Continuity	-----	-----
Initial LID Storage	0.017	0.012
Total Precipitation	460.288	339.070
Evaporation Loss	64.370	47.418
Infiltration Loss	149.852	110.388
Surface Runoff	217.862	160.488
LID Drainage	32.164	23.694
Final Storage	0.017	0.012
Continuity Error (%)	-0.860	

	Volume acre-feet	Volume 10^6 gal
Flow Routing Continuity	-----	-----
Dry Weather Inflow	0.000	0.000
Wet Weather Inflow	250.026	81.475
Groundwater Inflow	0.000	0.000
RDII Inflow	0.000	0.000
External Inflow	0.000	0.000
External Outflow	249.978	81.459
Flooding Loss	0.000	0.000
Evaporation Loss	0.000	0.000
Exfiltration Loss	0.000	0.000
Initial Stored Volume	0.000	0.000
Final Stored Volume	0.000	0.000
Continuity Error (%)	0.019	

\*\*\*\*\*  
 Highest Flow Instability Indexes  
 \*\*\*\*\*  
 All links are stable.

\*\*\*\*\*  
 Routing Time Step Summary

\*\*\*\*\*  
 Minimum Time Step : 15.00 sec  
 Average Time Step : 15.00 sec  
 Maximum Time Step : 15.00 sec  
 Percent in Steady State : 0.00  
 Average Iterations per Step : 1.00  
 Percent Not Converging : 0.00

\*\*\*\*\*  
 Subcatchment Runoff Summary

\*\*\*\*\*

Subcatchment	Total Precip in	Total Runon in	Total Evap in	Total Infil in	Imperv Runoff in	Perv Runoff in	Total Runoff in	Total Runoff 10^6 gal	Peak Runoff CFS	Runoff Coeff
DMA1	339.07	0.00	64.77	95.29	188.48	5.82	183.70	12.42	2.68	0.542
DMA3	339.07	0.00	44.29	113.11	178.91	5.36	184.27	69.05	14.42	0.543

\*\*\*\*\*  
 LID Performance Summary  
 \*\*\*\*\*

Subcatchment	LID Control	Total Inflow in	Evap Loss in	Infil Loss in	Surface Outflow in	Drain Outflow in	Initial Storage in	Final Storage in	Continuity Error %
DMA1	BMP1	6180.55	658.30	0.00	862.45	4660.03	2.40	2.40	-0.00

\*\*\*\*\*  
 Node Depth Summary  
 \*\*\*\*\*

Node	Type	Average Depth Feet	Maximum Depth Feet	Maximum HGL Feet	Time of Max Occurrence days hr:min	Reported Max Depth Feet
J1	JUNCTION	0.01	0.59	1.59	5532 14:01	0.59
J2	JUNCTION	0.00	0.36	2.36	4532 12:01	0.36
POC1	OUTFALL	0.01	0.59	0.59	5532 14:01	0.59
SU1	STORAGE	0.00	0.64	0.64	4532 12:01	0.64
SU2	STORAGE	0.07	4.91	4.91	5532 14:01	4.91

\*\*\*\*\*  
 Node Inflow Summary  
 \*\*\*\*\*

Node	Type	Maximum Lateral Inflow CFS	Maximum Total Inflow CFS	Time of Max Occurrence days hr:min	Lateral Inflow Volume 10^6 gal	Total Inflow Volume 10^6 gal	Flow Balance Error Percent
J1	JUNCTION	0.00	7.99	5532 14:01	0	71	0.000
J2	JUNCTION	0.00	2.56	4532 12:01	0	1.94	0.000
POC1	OUTFALL	0.04	8.03	5532 14:01	10.5	81.5	0.000
SU1	STORAGE	2.65	2.65	4532 12:00	1.94	1.94	0.000
SU2	STORAGE	14.42	14.42	4532 12:00	69	69	0.000

\*\*\*\*\*  
 Node Flooding Summary  
 \*\*\*\*\*

No nodes were flooded.

\*\*\*\*\*  
 Storage Volume Summary  
 \*\*\*\*\*

Storage Unit	Average Volume 1000 ft3	Avg Pcnt Full	Evap Pcnt Loss	Exfil Pcnt Loss	Maximum Volume 1000 ft3	Max Pcnt Full	Time of Max Occurrence days hr:min	Maximum Outflow CFS
SU1	0.020	1	0	0	3.173	85	4532 12:01	2.56
SU2	0.556	1	0	0	56.348	98	5532 14:01	6.65

\*\*\*\*\*  
 Outfall Loading Summary  
 \*\*\*\*\*

Outfall Node	Flow Freq Pcnt	Avg Flow CFS	Max Flow CFS	Total Volume 10^6 gal
POC1	8.37	0.11	8.03	81.453
System	8.37	0.11	8.03	81.453

\*\*\*\*\*  
 Link Flow Summary  
 \*\*\*\*\*

Link	Type	Maximum  Flow  CFS	Time of Max Occurrence days hr:min	Maximum  Veloc  ft/sec	Max/ Full Flow	Max/ Full Depth
C1	CONDUIT	7.99	5532 14:01	8.13	0.08	0.20
C2	CONDUIT	2.56	4532 12:01	5.96	0.04	0.14
OR1	ORIFICE	0.28	5532 14:01			0.00
OR2	ORIFICE	0.01	4532 12:01			0.00
W1	WEIR	6.37	5532 14:01			0.00
W2	WEIR	2.55	4532 12:01			0.00

\*\*\*\*\*  
Conduit Surcharge Summary  
\*\*\*\*\*

No conduits were surcharged.

Analysis begun on: Tue Jun 21 14:31:26 2022  
Analysis ended on: Tue Jun 21 14:32:43 2022  
Total elapsed time: 00:01:17

EPA STORM WATER MANAGEMENT MODEL - VERSION 5.1 (Build 5.1.015)

-----  
 Post Condition POC 2-DMA 2

\*\*\*\*\*  
 NOTE: The summary statistics displayed in this report are based on results found at every computational time step, not just on results from each reporting time step.  
 \*\*\*\*\*

\*\*\*\*\*  
 Analysis Options

\*\*\*\*\*  
 Flow Units ..... CFS  
 Process Models:  
 Rainfall/Runoff ..... YES  
 RDII ..... NO  
 Snowmelt ..... NO  
 Groundwater ..... NO  
 Flow Routing ..... YES  
 Ponding Allowed ..... NO  
 Water Quality ..... NO  
 Infiltration Method ..... GREEN\_AMPT  
 Flow Routing Method ..... KINWAVE  
 Starting Date ..... 10/03/1970 05:00:00  
 Ending Date ..... 05/25/2008 22:00:00  
 Antecedent Dry Days ..... 0.0  
 Report Time Step ..... 01:00:00  
 Wet Time Step ..... 00:15:00  
 Dry Time Step ..... 00:15:00  
 Routing Time Step ..... 15.00 sec

*****	Volume	Depth
Runoff Quantity Continuity	acre-feet	inches
*****	-----	-----
Initial LID Storage .....	0.021	0.062
Total Precipitation .....	113.306	339.070
Evaporation Loss .....	18.245	54.599
Infiltration Loss .....	43.736	130.881
Surface Runoff .....	6.230	18.643
LID Drainage .....	46.227	138.336
Final Storage .....	0.021	0.062
Continuity Error (%) .....	-1.000	

*****	Volume	Volume
Flow Routing Continuity	acre-feet	10^6 gal
*****	-----	-----
Dry Weather Inflow .....	0.000	0.000
Wet Weather Inflow .....	52.457	17.094
Groundwater Inflow .....	0.000	0.000
RDII Inflow .....	0.000	0.000
External Inflow .....	0.000	0.000
External Outflow .....	52.457	17.094
Flooding Loss .....	0.000	0.000
Evaporation Loss .....	0.000	0.000
Exfiltration Loss .....	0.000	0.000
Initial Stored Volume .....	0.000	0.000
Final Stored Volume .....	0.000	0.000
Continuity Error (%) .....	0.000	

\*\*\*\*\*  
 Highest Flow Instability Indexes  
 \*\*\*\*\*  
 All links are stable.

\*\*\*\*\*  
 Routing Time Step Summary

\*\*\*\*\*  
 Minimum Time Step : 15.00 sec  
 Average Time Step : 15.00 sec  
 Maximum Time Step : 15.00 sec  
 Percent in Steady State : 0.00  
 Average Iterations per Step : 1.00  
 Percent Not Converging : 0.00

\*\*\*\*\*  
 Subcatchment Runoff Summary  
 \*\*\*\*\*

-----	Total	Total	Total	Total	Imperv	Perv	Total	Total	Peak	Runoff
Subcatchment	Precip	Runon	Evap	Infil	Runoff	Runoff	Runoff	Runoff	Runoff	Coeff
-----	in	in	in	in	in	in	in	10^6 gal	CFS	-----
DMA2	339.07	0.00	54.60	130.88	158.40	6.91	156.98	17.09	4.25	0.463

\*\*\*\*\*  
 LID Performance Summary

\*\*\*\*\*

Subcatchment	LID Control	Total Inflow in	Evap Loss in	Infil Loss in	Surface Outflow in	Drain Outflow in	Initial Storage in	Final Storage in	Continuity Error %
DMA2	BMP2	6723.76	661.32	0.00	720.02	5342.66	2.40	2.40	-0.00

\*\*\*\*\*  
Node Depth Summary  
\*\*\*\*\*

Node	Type	Average Depth Feet	Maximum Depth Feet	Maximum HGL Feet	Time of Max Occurrence days hr:min	Reported Max Depth Feet
POC2	OUTFALL	0.00	0.00	0.00	0 00:00	0.00
SU1	STORAGE	0.00	1.16	1.16	4532 12:05	1.11

\*\*\*\*\*  
Node Inflow Summary  
\*\*\*\*\*

Node	Type	Maximum Lateral Inflow CFS	Maximum Total Inflow CFS	Time of Max Occurrence days hr:min	Lateral Inflow Volume 10^6 gal	Total Inflow Volume 10^6 gal	Flow Balance Error Percent
POC2	OUTFALL	0.05	3.28	4532 12:05	15.1	17.1	0.000
SU1	STORAGE	4.20	4.20	4532 12:00	2.03	2.03	0.004

\*\*\*\*\*  
Node Flooding Summary  
\*\*\*\*\*

No nodes were flooded.

\*\*\*\*\*  
Storage Volume Summary  
\*\*\*\*\*

Storage Unit	Average Volume 1000 ft3	Avg Pcnt Full	Evap Pcnt Loss	Exfil Pcnt Loss	Maximum Volume 1000 ft3	Max Pcnt Full	Time of Max Occurrence days hr:min	Maximum Outflow CFS
SU1	0.022	0	0	0	6.178	92	4532 12:05	3.23

\*\*\*\*\*  
Outfall Loading Summary  
\*\*\*\*\*

Outfall Node	Flow Freq Pcnt	Avg Flow CFS	Max Flow CFS	Total Volume 10^6 gal
POC2	7.80	0.02	3.28	17.093
System	7.80	0.02	3.28	17.093

\*\*\*\*\*  
Link Flow Summary  
\*\*\*\*\*

Link	Type	Maximum  Flow  CFS	Time of Max Occurrence days hr:min	Maximum  Veloc  ft/sec	Max/ Full Flow	Max/ Full Depth
OR2	ORIFICE	0.03	4532 12:05			0.00
W1	WEIR	3.20	4532 12:05			0.00

\*\*\*\*\*  
Conduit Surcharge Summary  
\*\*\*\*\*

No conduits were surcharged.

Analysis begun on: Wed Jun 22 08:12:37 2022  
Analysis ended on: Wed Jun 22 08:13:14 2022  
Total elapsed time: 00:00:37

**ATTACHMENT E**

**Flow Frequency Statistical Analysis**

## Pre-project Flow Frequency - Long-term Simulation

Statistics - Node POC1 Total Inflow

Rank	Start Date	Event Duration (hours)	Event Peak (CFS)	Exceedance Frequency (percent)	Return Period (years)
1	3/1/1983	30	14.967	1.28	39
2	11/25/1985	16	6.514	2.56	19.5
3	1/11/2005	5	6.181	3.85	13
4	3/24/1983	2	5.725	5.13	9.75
5	12/21/1970	2	5.455	6.41	7.8
6	1/16/1978	3	5.273	7.69	6.5
7	10/19/2004	32	4.864	8.97	5.57
8	11/11/1972	1	4.395	10.26	4.88
9	2/21/2005	3	4.356	11.54	4.33
10	1/3/2005	21	4.278	12.82	3.9
11	2/28/1991	11	3.908	14.1	3.55
12	3/27/1991	2	3.885	15.38	3.25
13	8/16/1977	6	3.828	16.67	3
14	4/1/1982	2	3.796	17.95	2.79
15	2/22/2004	5	3.767	19.23	2.6
16	3/2/2004	2	3.642	20.51	2.44
17	1/31/1979	11	3.461	21.79	2.29
18	3/19/1983	1	3.4	23.08	2.17
19	12/7/1992	3	3.394	24.36	2.05
20	2/19/1993	2	3.131	25.64	1.95
21	1/29/1980	5	2.95	26.92	1.86
22	11/29/1970	3	2.83	28.21	1.77
23	2/23/2005	1	2.468	29.49	1.7
24	1/4/1995	5	2.446	30.77	1.63
25	12/27/1984	22	2.357	32.05	1.56
26	3/1/1978	1	2.313	33.33	1.5
27	3/6/1980	5	2.261	34.62	1.44
28	4/28/1994	2	2.205	35.9	1.39
29	3/1/1981	10	2.032	37.18	1.34
30	1/15/1993	19	1.886	38.46	1.3
31	3/2/1992	4	1.836	39.74	1.26
32	12/4/1992	1	1.802	41.03	1.22
33	3/10/1975	2	1.628	42.31	1.18
34	3/17/1982	9	1.571	43.59	1.15
35	2/6/1992	4	1.466	44.87	1.11
36	3/21/1983	1	1.453	46.15	1.08
37	11/10/1982	1	1.284	47.44	1.05
38	12/7/1986	1	1.23	48.72	1.03
39	3/7/1992	1	1.203	50	1
40	9/10/1976	14	1.182	51.28	0.98
41	2/10/1978	2	1.175	52.56	0.95
42	11/12/1976	1	1.167	53.85	0.93
43	2/20/1980	21	1.162	55.13	0.91
44	10/10/1986	4	1.088	56.41	0.89
45	12/29/1977	1	1.066	57.69	0.87
46	3/7/1974	1	1.04	58.97	0.85
47	8/14/1983	1	1.024	60.26	0.83
48	1/25/1995	2	0.971	61.54	0.81
49	1/12/1993	3	0.935	62.82	0.8
50	1/29/1983	2	0.896	64.1	0.78
51	12/11/1984	4	0.864	65.38	0.76
52	3/5/2000	1	0.724	66.67	0.75
53	3/16/1986	1	0.672	67.95	0.74
54	2/26/1987	1	0.562	69.23	0.72
55	10/11/1987	1	0.53	70.51	0.71
56	2/26/2004	1	0.529	71.79	0.7
57	10/23/1976	1	0.511	73.08	0.68
58	3/20/1973	1	0.481	74.36	0.67
59	1/1/1982	2	0.454	75.64	0.66
60	10/30/1998	1	0.438	76.92	0.65
61	2/8/1976	5	0.405	78.21	0.64
62	2/14/1995	1	0.398	79.49	0.63
63	3/20/1991	1	0.396	80.77	0.62
64	2/2/1988	2	0.394	82.05	0.61
65	11/14/1978	1	0.377	83.33	0.6
66	3/5/1978	1	0.373	84.62	0.59
69	12/19/1970	1	0.321	88.46	0.57
69	1/6/1993	17	0.321	88.46	0.57
69	1/7/1974	25	0.321	88.46	0.57
70	3/11/1978	3	0.32	89.74	0.56
71	4/29/1980	1	0.286	91.03	0.55
72	11/22/1984	1	0.207	92.31	0.54
73	1/15/1978	1	0.202	93.59	0.53
74	1/4/1974	1	0.137	94.87	0.53
75	2/2/1983	1	0.083	96.15	0.52

(years)

10-year Q: 5.760 cfs

5-year Q: 4.477 cfs

2-year Q: 3.263 cfs

Lower Flow Threshold: 10%

0.1xQ2 0.326 cfs

## Post-project Flow Frequency - Long-term Simulation

Statistics - Node POC1 Total Inflow

Rank	Start Date	Event Duration (hours)	Event Peak (CFS)	Exceedance Frequency (percent)	Return Period (years)
1	3/1/1983	30	14.961	1.28	39
2	11/25/1985	16	6.548	2.56	19.5
3	1/11/2005	5	6.206	3.85	13
4	3/24/1983	2	5.771	5.13	9.75
5	12/21/1970	2	5.485	6.41	7.8
6	1/16/1978	3	5.272	7.69	6.5
7	10/19/2004	32	4.903	8.97	5.57
8	11/11/1972	1	4.434	10.26	4.88
9	2/21/2005	3	4.346	11.54	4.33
10	1/3/2005	21	4.297	12.82	3.9
11	2/28/1991	11	3.944	14.1	3.55
12	3/27/1991	2	3.905	15.38	3.25
13	8/16/1977	6	3.844	16.67	3
14	4/1/1982	2	3.828	17.95	2.79
15	2/22/2004	5	3.793	19.23	2.6
16	3/2/2004	2	3.674	20.51	2.44
17	1/31/1979	11	3.465	21.79	2.29
18	3/19/1983	1	3.431	23.08	2.17
19	12/7/1992	3	3.385	24.36	2.05
20	2/19/1993	2	3.162	25.64	1.95
21	1/29/1980	5	2.948	26.92	1.86
22	11/29/1970	3	2.834	28.21	1.77
23	2/23/2005	1	2.492	29.49	1.7
24	1/4/1995	5	2.45	30.77	1.63
25	12/27/1984	22	2.375	32.05	1.56
26	3/1/1978	1	2.33	33.33	1.5
27	3/6/1980	5	2.256	34.62	1.44
28	4/28/1994	2	2.228	35.9	1.39
29	3/1/1981	10	2.053	37.18	1.34
30	1/15/1993	19	1.89	38.46	1.3
31	3/2/1992	4	1.856	39.74	1.26
32	12/4/1992	1	1.819	41.03	1.22
33	3/10/1975	2	1.635	42.31	1.18
34	3/17/1982	9	1.585	43.59	1.15
35	2/6/1992	4	1.471	44.87	1.11
36	3/21/1983	1	1.467	46.15	1.08
37	11/10/1982	1	1.298	47.44	1.05
38	12/7/1986	1	1.243	48.72	1.03
39	3/7/1992	1	1.216	50	1
40	9/10/1976	14	1.194	51.28	0.98
41	2/10/1978	2	1.184	52.56	0.95
42	11/12/1976	1	1.177	53.85	0.93
43	2/20/1980	21	1.173	55.13	0.91
44	10/10/1986	4	1.099	56.41	0.89
45	12/29/1977	1	1.077	57.69	0.87
46	3/7/1974	1	1.05	58.97	0.85
47	8/14/1983	1	1.031	60.26	0.83
48	1/25/1995	2	0.977	61.54	0.81
49	1/12/1993	3	0.94	62.82	0.8
50	1/29/1983	2	0.905	64.1	0.78
51	12/11/1984	4	0.868	65.38	0.76
52	3/5/2000	1	0.731	66.67	0.75
53	3/16/1986	1	0.677	67.95	0.74
54	2/26/1987	1	0.568	69.23	0.72
55	2/26/2004	1	0.534	70.51	0.71
56	10/11/1987	1	0.533	71.79	0.7
57	10/23/1976	1	0.514	73.08	0.68
58	3/20/1973	1	0.484	74.36	0.67
59	1/1/1982	2	0.457	75.64	0.66
60	10/30/1998	1	0.44	76.92	0.65
61	2/8/1976	5	0.407	78.21	0.64
62	2/14/1995	1	0.402	79.49	0.63
63	3/20/1991	1	0.397	80.77	0.62
64	2/2/1988	2	0.396	82.05	0.61
65	11/14/1978	1	0.38	83.33	0.6
66	3/5/1978	1	0.377	84.62	0.59
67	3/11/1978	3	0.324	85.9	0.58
70	12/19/1970	1	0.323	89.74	0.56
70	1/7/1974	25	0.323	89.74	0.56
70	1/6/1993	17	0.323	89.74	0.56
71	4/29/1980	1	0.287	91.03	0.55
72	11/22/1984	1	0.208	92.31	0.54
73	1/15/1978	1	0.204	93.59	0.53
74	1/4/1974	1	0.137	94.87	0.53
75	2/2/1983	1	0.084	96.15	0.52

10-year Q: 5.804 cfs  
 5-year Q: 4.516 cfs  
 2-year Q: 3.274 cfs

Lower Flow Threshold: 10%

0.1xQ2: 0.327 cfs



## Pre-project Flow Frequency - Long-term Simulation

DMA 2 POC 2

Statistics - Node POC2 Total Inflow

Rank	Start Date	Event Duration (hours)	Event Peak (CFS)	Exceedance Frequency (percent)	Return Period (years)
1	3/1/1983	31	3.562	1.32	39
2	11/25/1985	16	1.486	2.63	19.5
3	1/11/2005	5	1.423	3.95	13
4	3/24/1983	2	1.264	5.26	9.75
5	1/16/1978	3	1.252	6.58	7.8
6	12/21/1970	2	1.243	7.89	6.5
7	10/19/2004	32	1.075	9.21	5.57
8	2/21/2005	3	1.049	10.53	4.88
9	1/3/2005	21	0.982	11.84	4.33
10	11/11/1972	1	0.958	13.16	3.9
11	3/27/1991	2	0.886	14.47	3.55
12	8/16/1977	6	0.877	15.79	3.25
13	2/28/1991	11	0.849	17.11	3
14	2/22/2004	5	0.845	18.42	2.79
15	4/1/1982	2	0.833	19.74	2.6
16	12/7/1992	3	0.816	21.05	2.44
17	1/31/1979	11	0.809	22.37	2.29
18	3/2/2004	2	0.797	23.68	2.17
19	3/19/1983	1	0.739	25	2.05
20	1/29/1980	5	0.701	26.32	1.95
21	2/19/1993	2	0.67	27.63	1.86
22	11/29/1970	3	0.663	28.95	1.77
23	1/4/1995	5	0.571	30.26	1.7
24	3/6/1980	5	0.543	31.58	1.63
25	2/23/2005	1	0.527	32.89	1.56
26	12/27/1984	23	0.526	34.21	1.5
27	3/1/1978	1	0.515	35.53	1.44
28	4/28/1994	2	0.463	36.84	1.39
29	1/15/1993	19	0.441	38.16	1.34
30	3/1/1981	10	0.423	39.47	1.3
31	3/2/1992	4	0.379	40.79	1.26
32	3/10/1975	2	0.372	42.11	1.22
33	12/4/1992	1	0.354	43.42	1.18
34	3/17/1982	9	0.343	44.74	1.15
35	2/6/1992	4	0.34	46.05	1.11
36	3/21/1983	1	0.286	47.37	1.08
37	2/10/1978	2	0.263	48.68	1.05
38	11/10/1982	1	0.259	50	1.03
39	12/7/1986	1	0.246	51.32	1
40	3/7/1992	1	0.24	52.63	0.98
41	9/10/1976	14	0.236	53.95	0.95
42	2/20/1980	21	0.234	55.26	0.93
43	11/12/1976	1	0.226	56.58	0.91
44	1/25/1995	2	0.221	57.89	0.89
45	10/10/1986	4	0.215	59.21	0.87
46	12/29/1977	1	0.211	60.53	0.85
47	1/12/1993	3	0.209	61.84	0.83
48	3/7/1974	1	0.205	63.16	0.81
49	12/11/1984	4	0.194	64.47	0.8
50	8/14/1983	1	0.191	65.79	0.78
51	1/29/1983	2	0.174	67.11	0.76
52	3/5/2000	1	0.139	68.42	0.75
53	3/16/1986	1	0.127	69.74	0.74
54	2/26/1987	1	0.113	71.05	0.72
55	2/26/2004	1	0.101	72.37	0.71
56	10/11/1987	1	0.097	73.68	0.7
57	10/23/1976	1	0.095	75	0.68
58	2/8/1976	5	0.09	76.32	0.67
59	3/20/1973	1	0.089	77.63	0.66
60	1/1/1982	2	0.085	78.95	0.65
61	10/30/1998	1	0.08	80.26	0.64
62	2/14/1995	1	0.078	81.58	0.63
63	3/5/1978	1	0.077	82.89	0.62
64	2/2/1988	2	0.072	84.21	0.61
65	3/20/1991	1	0.072	85.53	0.6
66	11/14/1978	1	0.072	86.84	0.59
67	3/11/1978	3	0.067	88.16	0.58
70	12/19/1970	1	0.059	92.11	0.56
70	1/6/1993	17	0.059	92.11	0.56
70	1/7/1974	25	0.059	92.11	0.56
71	4/29/1980	1	0.052	93.42	0.55
72	1/15/1978	1	0.038	94.74	0.54
73	11/22/1984	1	0.037	96.05	0.53
74	1/4/1974	1	0.024	97.37	0.53
75	2/2/1983	1	0.016	98.68	0.52

(years)

10-year Q: 1.276 cfs

5-year Q: 1.054 cfs

2-year Q: 0.720 cfs

Lower Flow Threshold: 10%

0.1xQ2: 0.072 cfs

## Post-project Flow Frequency - Long-term Simulation

DMA 2 POC 2

Statistics - Node POC2 Total Inflow

Rank	Start Date	Event Duration (hours)	Event Peak (CFS)	Exceedance Frequency (percent)	Return Period (years)
1	11/24/1985	160	2.06	0.26	39
2	2/24/1983	264	1.541	0.53	19.5
3	12/4/1992	159	1.267	0.79	13
4	1/31/1979	122	1.256	1.06	9.75
5	2/18/2005	195	1.172	1.32	7.8
6	2/21/2004	156	1.083	1.58	6.5
7	10/17/2004	165	0.958	1.85	5.57
8	2/27/1991	117	0.942	2.11	4.88
9	1/28/1980	122	0.917	2.37	4.33
10	1/3/2005	268	0.647	2.64	3.9
11	1/14/1978	159	0.563	2.9	3.55
12	1/12/1993	204	0.548	3.17	3.25
13	12/28/2004	113	0.533	3.43	3
14	3/14/1982	161	0.524	3.69	2.79
15	1/3/1995	145	0.377	3.96	2.6
16	1/6/1993	133	0.364	4.22	2.44
17	2/4/1976	224	0.339	4.49	2.29
18	12/17/1970	182	0.278	4.75	2.17
19	12/27/1984	101	0.277	5.01	2.05
20	2/6/1992	256	0.077	5.28	1.95
21	3/2/1992	87	0.073	5.54	1.86
22	3/6/1980	78	0.072	5.8	1.77
23	2/27/1978	193	0.072	6.07	1.7
24	8/16/1977	83	0.071	6.33	1.63
25	3/25/1991	119	0.071	6.6	1.56
26	11/11/1985	86	0.07	6.86	1.5
27	11/10/1972	158	0.07	7.12	1.44
28	3/4/2005	75	0.07	7.39	1.39
29	3/15/2003	81	0.068	7.65	1.34
30	2/15/1986	78	0.068	7.92	1.3
31	3/19/1991	126	0.068	8.18	1.26
32	12/16/1987	115	0.067	8.44	1.22
33	3/5/1995	85	0.066	8.71	1.18
34	10/27/2004	79	0.065	8.97	1.15
35	12/10/1984	86	0.064	9.23	1.11
36	2/19/2007	118	0.064	9.5	1.08
37	2/14/1995	84	0.064	9.76	1.05
38	11/21/1996	78	0.064	10.03	1.03
39	11/12/1976	72	0.063	10.29	1
40	3/17/1983	241	0.063	10.55	0.98
41	2/28/1981	181	0.062	10.82	0.95
42	1/24/1995	111	0.059	11.08	0.93
43	2/2/1988	81	0.059	11.35	0.91
44	1/25/1999	105	0.058	11.61	0.89
45	11/29/1970	72	0.057	11.87	0.87
46	3/6/1975	208	0.055	12.14	0.85
47	2/18/1993	215	0.054	12.4	0.83
48	1/5/1979	75	0.054	12.66	0.81
49	8/14/1983	127	0.05	12.93	0.8
50	11/30/2007	74	0.05	13.19	0.78
51	12/17/1978	118	0.05	13.46	0.76
52	1/20/1982	81	0.05	13.72	0.75
53	12/6/1986	98	0.05	13.98	0.74
54	2/19/1980	106	0.05	14.25	0.72
55	3/20/1973	69	0.05	14.51	0.71
56	11/9/1982	82	0.05	14.78	0.7
57	1/5/2008	109	0.05	15.04	0.68
58	1/5/1987	92	0.05	15.3	0.67
59	2/2/1983	84	0.05	15.57	0.66
60	2/11/2005	98	0.049	15.83	0.65
61	12/4/1972	128	0.049	16.09	0.64
62	3/10/1980	65	0.049	16.36	0.63
63	5/8/1977	70	0.049	16.62	0.62
64	12/25/1988	83	0.049	16.89	0.61
65	4/1/1982	62	0.049	17.15	0.6
66	2/24/1987	102	0.049	17.41	0.59
67	3/11/1995	76	0.048	17.68	0.58
68	10/9/1986	66	0.048	17.94	0.57
69	3/2/2004	58	0.048	18.21	0.57
70	10/11/1987	81	0.048	18.47	0.56
71	9/25/1986	58	0.048	18.73	0.55
72	9/10/1976	72	0.048	19	0.54
73	1/4/1974	159	0.048	19.26	0.53
74	1/5/1992	88	0.048	19.53	0.53
75	1/12/1997	110	0.048	19.79	0.52

10-year Q: 1.257 cfs  
 5-year Q: 0.945 cfs  
 2-year Q: 0.277 cfs

Lower Flow Threshold: 10%

0.1xQ2: 0.028 cfs

**ATTACHMENT F**

**Flow Duration Comparison Curve**

# Node POC1

Flow Duration Curve Comparison

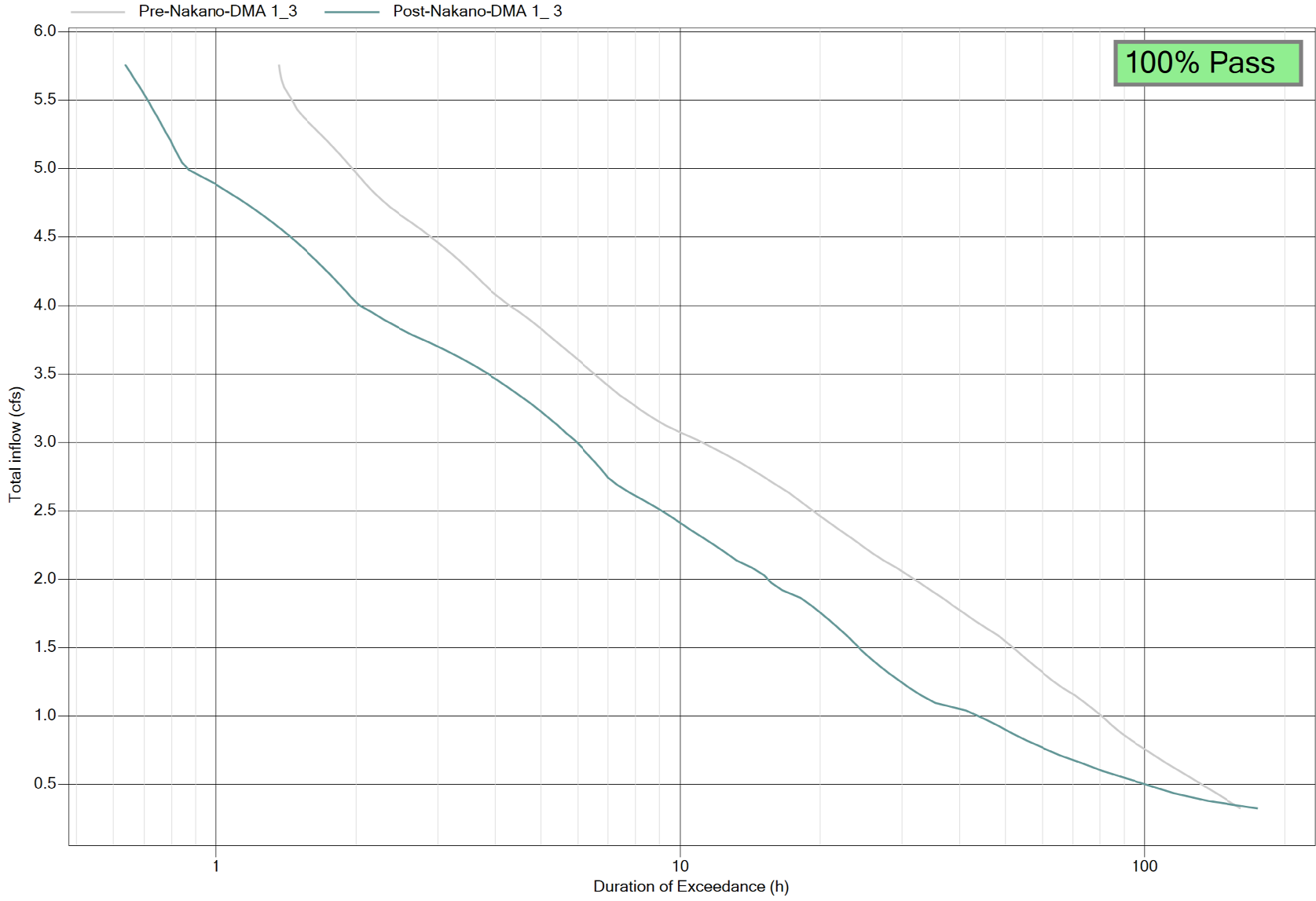

# Node POC2

Flow Duration Curve Comparison

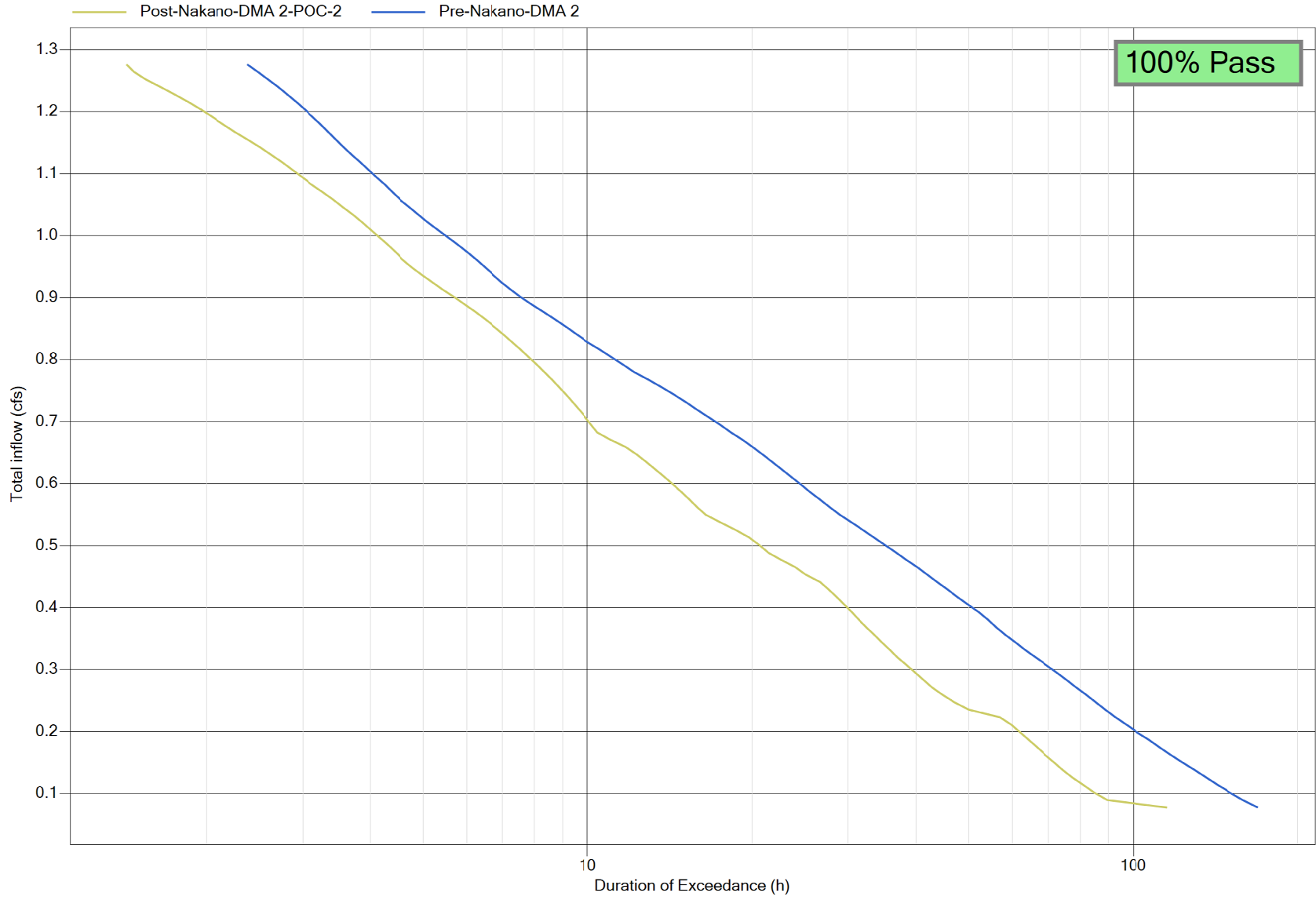

# **ATTACHMENT 3**

## **Structural BMP Maintenance Information Hydromodification Control Measures**

Project Name/\_\_\_\_\_

**Use this checklist to ensure the required information has been included in the Structural BMP Maintenance Information Attachment:**

**Attachment 3:** For private entity operation and maintenance, Attachment 3 must include a Storm Water Management Facilities Maintenance Agreement with Grant of Access and Covenant's ("Maintenance Agreement") Template can be found at the following link (also refer to Chapter 8.2.1 for more information's):

The following information must be included in the exhibits attached to the Maintenance Agreement:

- Vicinity map (Depiction of Project Site)
- Legal Description for Project Site
- Site design BMPs for which DCV reduction is claimed for meeting the pollutant control obligations.
- BMP and HMP type, location, type, manufacture model, and dimensions, specifications, cross section
- LID features such as (permeable paver and LS location, dim, SF).
- Maintenance recommendations and frequency



# Inspection Guidelines for Modular Wetland System - Linear

## Inspection Summary

- Inspect Pre-Treatment, Biofiltration and Discharge Chambers – average inspection interval is 6 to 12 months.
  - *(15 minute average inspection time).*
- **NOTE:** Pollutant loading varies greatly from site to site and no two sites are the same. Therefore, the first year requires inspection monthly during the wet season and every other month during the dry season in order to observe and record the amount of pollutant loading the system is receiving.

## System Diagram

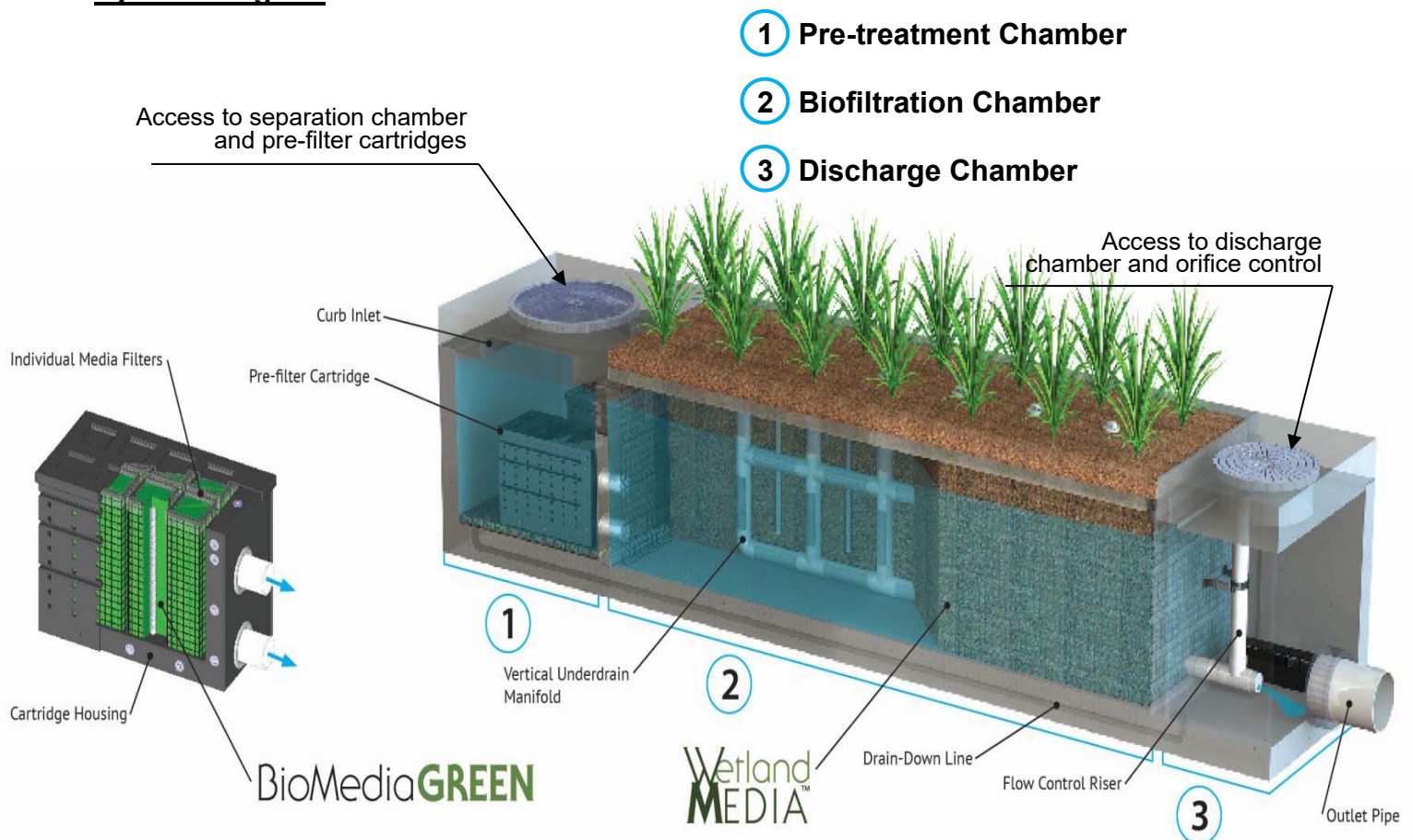



## Inspection Overview

As with all stormwater BMPs inspection and maintenance on the MWS Linear is necessary. Stormwater regulations require that all BMPs be inspected and maintained to ensure they are operating as designed to allow for effective pollutant removal and provide protection to receiving water bodies. It is recommended that inspections be performed multiple times during the first year to assess the site specific loading conditions. This is recommended because pollutant loading and pollutant characteristics can vary greatly from site to site. Variables such as nearby soil erosion or construction sites, winter sanding on roads, amount of daily traffic and land use can increase pollutant loading on the system. The first year of inspections can be used to set inspection and maintenance intervals for subsequent years to ensure appropriate maintenance is provided. Without appropriate maintenance a BMP will exceed its storage capacity which can negatively affect its continued performance in removing and retaining captured pollutants.

### Inspection Equipment

Following is a list of equipment to allow for simple and effective inspection of the MWS Linear:

- Modular Wetland Inspection Form
- Flashlight
- Manhole hook or appropriate tools to remove access hatches and covers
- Appropriate traffic control signage and procedures
- Measuring pole and/or tape measure.
- Protective clothing and eye protection.
- 7/16" open or closed ended wrench.
- **Large permanent black marker (initial inspections only – first year)**
- Note: entering a confined space requires appropriate safety and certification. It is generally not required for routine inspections of the system.





## **Inspection Steps**

The core to any successful stormwater BMP maintenance program is routine inspections. The inspection steps required on the MWS Linear are quick and easy. As mentioned above the first year should be seen as the maintenance interval establishment phase. During the first year more frequent inspections should occur in order to gather loading data and maintenance requirements for that specific site. This information can be used to establish a base for long term inspection and maintenance interval requirements.

The MWS Linear can be inspected through visual observation without entry into the system. All necessary pre-inspection steps must be carried out before inspection occurs, especially traffic control and other safety measures to protect the inspector and near-by pedestrians from any dangers associated with an open access hatch or manhole. Once these access covers have been safely opened the inspection process can proceed:

- Prepare the inspection form by writing in the necessary information including project name, location, date & time, unit number and other info (see inspection form).
- Observe the inside of the system through the access hatches. If minimal light is available and vision into the unit is impaired utilize a flashlight to see inside the system and all of its chambers.
- Look for any out of the ordinary obstructions in the inflow pipe, pre-treatment chamber, biofiltration chamber, discharge chamber or outflow pipe. Write down any observations on the inspection form.
- Through observation and/or digital photographs estimate the amount of trash, debris and sediment accumulated in the pre-treatment chamber. Utilizing a tape measure or measuring stick estimate the amount of trash, debris and sediment in this chamber. Record this depth on the inspection form.

- Through visual observation inspect the condition of the pre-filter cartridges. Look for excessive build-up of sediments on the cartridges, any build-up on the top of the cartridges, or clogging of the holes. Record this information on the inspection form. The pre-filter cartridges can further be inspected by removing the cartridge tops and assessing the color of the BioMediaGREEN filter cubes (requires entry into pre-treatment chamber – see notes above regarding confined space entry). Record the color of the material. New material is a light green in color. As the media becomes clogged it will turn darker in color, eventually becoming dark brown or black. Using the below color indicator record the percentage of media exhausted.

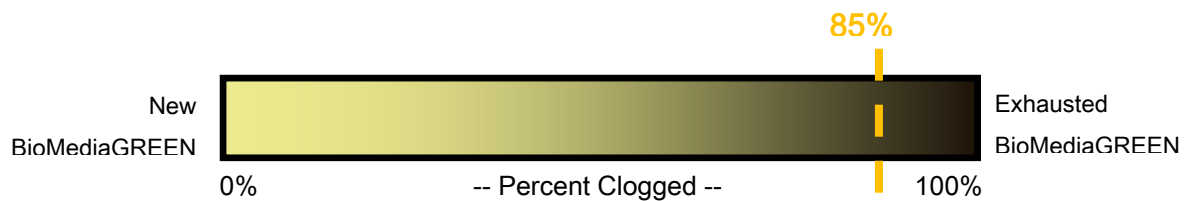

- The biofiltration chamber is generally maintenance free due to the system's advanced pre-treatment chamber. For units which have open planters with vegetation it is recommended that the vegetation be inspected. Look for any plants that are dead or showing signs of disease or other negative stressors. Record the general health of the plants on the inspection and indicate through visual observation or digital photographs if trimming of the vegetation is needed.
- The discharge chamber houses the orifice control structure and is connected to the outflow pipe. It is important to check to ensure the orifice is in proper operating conditions and free of any obstructions. Generally, the discharge chamber will be clean and free of debris. Inspect the water marks on the side walls. If possible, inspect the discharge chamber during a rain event to assess the amount of flow leaving the system while it is at 100% capacity (pre-treatment chamber water level at peak HGL). The water level of the flowing water should be compared to the watermark level on the side walls which is an indicator of the highest discharge rate the system achieved when initially installed. Record on the form is there is any difference in level from watermark in inches.

- NOTE: During the first few storms the water level in the outflow chamber should be observed and a 6" long horizontal watermark line drawn (using a large permanent marker) at the water level in the discharge chamber while the system is operating at 100% capacity. The diagram below illustrates where a line should be drawn. This line is a reference point for future inspections of the system:



Using a permanent marker draw a 6 inch long horizontal line, as shown, at the higher water level in the MWS Linear discharge chamber.

- Water level in the discharge chamber is a function of flow rate and pipe size. Observation of water level during the first few months of operation can be used as a benchmark level for future inspections. The initial mark and all future observations shall be made when system is at 100% capacity (water level at maximum level in pre-treatment chamber). If future water levels are below this mark when system is at 100% capacity this is an indicator that maintenance to the pre-filter cartridges may be needed.
- Finalize inspection report for analysis by the maintenance manager to determine if maintenance is required.

## **Maintenance Indicators**

Based upon observations made during inspection, maintenance of the system may be required based on the following indicators:

- Missing or damaged internal components or cartridges.
- Obstructions in the system or its inlet or outlet.
- Excessive accumulation of floatables in the pre-treatment chamber in which the length and width of the chamber is fully impacted more than 18”.

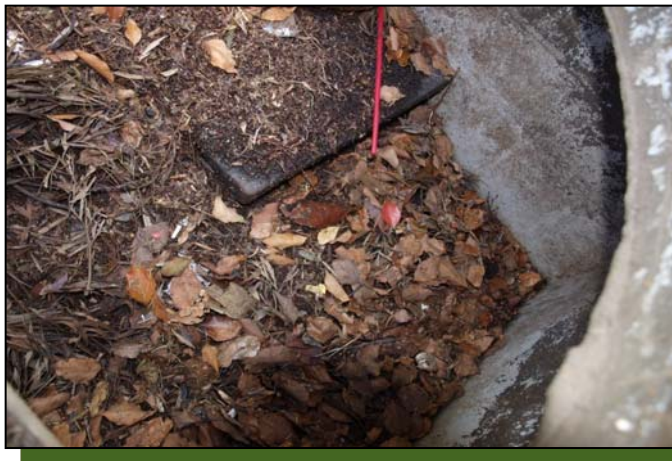

- Excessive accumulation of sediment in the pre-treatment chamber of more than 6” in depth.



- Excessive accumulation of sediment on the BioMediaGREEN media housed within the pre-filter cartridges. The following chart shows photos of the condition of the BioMediaGREEN contained within the pre-filter cartridges. When media is more than 85% clogged replacement is required.



- Overgrown vegetation.



- Water level in discharge chamber during 100% operating capacity (pre-treatment chamber water level at max height) is lower than the watermark by 20%.



## **Inspection Notes**

1. Following maintenance and/or inspection, it is recommended the maintenance operator prepare a maintenance/inspection record. The record should include any maintenance activities performed, amount and description of debris collected, and condition of the system and its various filter mechanisms.
2. The owner should keep maintenance/inspection record(s) for a minimum of five years from the date of maintenance. These records should be made available to the governing municipality for inspection upon request at any time.
3. Transport all debris, trash, organics and sediments to approved facility for disposal in accordance with local and state requirements.
4. Entry into chambers may require confined space training based on state and local regulations.
5. No fertilizer shall be used in the Biofiltration Chamber.
6. Irrigation should be provided as recommended by manufacturer and/or landscape architect. Amount of irrigation required is dependent on plant species. Some plants may not require irrigation after initial establishment.



# Maintenance Guidelines for Modular Wetland System - Linear

## Maintenance Summary

- Remove Sediment from Pre-Treatment Chamber – average maintenance interval is 12 to 24 months.
  - (10 minute average service time).
- Replace Pre-Filter Cartridge Media – average maintenance interval 12 to 24 months.
  - (10-15 minute per cartridge average service time).
- Trim Vegetation – average maintenance interval is 6 to 12 months.
  - (Service time varies).

## System Diagram

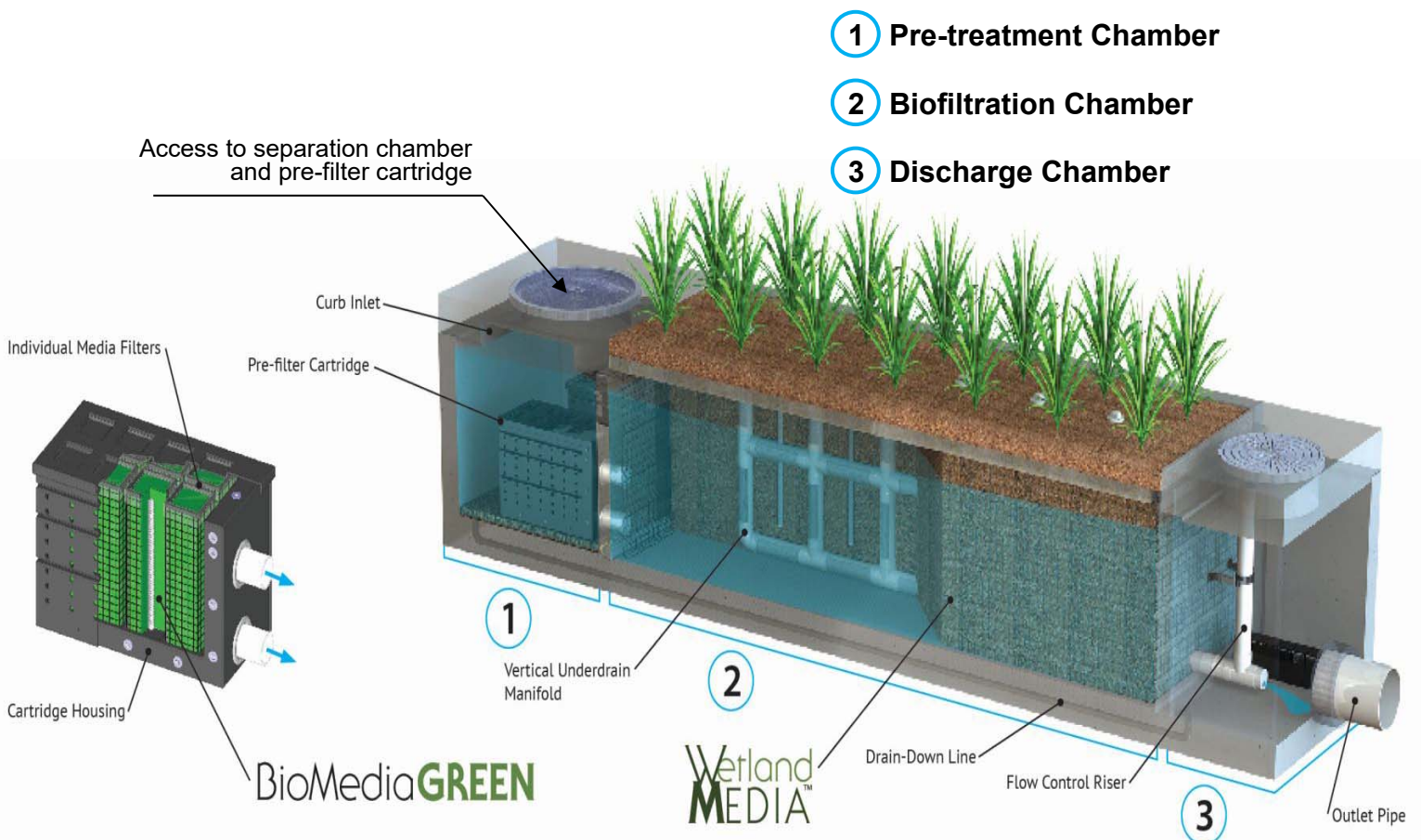



## Maintenance Overview

The time has come to maintain your Modular Wetland System Linear (MWS Linear). To ensure successful and efficient maintenance on the system we recommend the following. The MWS Linear can be maintained by removing the access hatches over the systems various chambers. All necessary pre-maintenance steps must be carried out before maintenance occurs, especially traffic control and other safety measures to protect the inspector and near-by pedestrians from any dangers associated with an open access hatch or manhole. Once traffic control has been set up per local and state regulations and access covers have been safely opened the maintenance process can begin. It should be noted that some maintenance activities require confined space entry. All confined space requirements must be strictly followed before entry into the system. In addition the following is recommended:

- Prepare the maintenance form by writing in the necessary information including project name, location, date & time, unit number and other info (see maintenance form).
- Set up all appropriate safety and cleaning equipment.
- Ensure traffic control is set up and properly positioned.
- Prepare a pre-checks (OSHA, safety, confined space entry) are performed.

### Maintenance Equipment

Following is a list of equipment required for maintenance of the MWS Linear:

- Modular Wetland Maintenance Form
- Manhole hook or appropriate tools to access hatches and covers
- Protective clothing, flashlight and eye protection.
- 7/16" open or closed ended wrench.
- Vacuum assisted truck with pressure washer.
- Replacement BioMediaGREEN for Pre-Filter Cartridges if required (order from manufacturer).



## Maintenance Steps

1. Pre-treatment Chamber (bottom of chamber)
  - A. Remove access hatch or manhole cover over pre-treatment chamber and position vacuum truck accordingly.
  - B. With a pressure washer spray down pollutants accumulated on walls and pre-filter cartridges.
  - C. Vacuum out Pre-Treatment Chamber and remove all accumulated pollutants including trash, debris and sediments. Be sure to vacuum the floor until pervious pavers are visible and clean.
  - D. If Pre-Filter Cartridges require media replacement move onto step 2. If not, replace access hatch or manhole cover.



Removal of access hatch to gain access below.



Insertion of vacuum hose into separation chamber.



Removal of trash, sediment and debris.



Fully cleaned separation chamber.

2. Pre-Filter Cartridges (attached to wall of pre-treatment chamber)

- A. After finishing step 1 enter pre-treatment chamber.
- B. Unscrew the two bolts holding the lid on each cartridge filter and remove lid.



Pre-filter cartridges with tops on.



Inside cartridges showing media filters ready for replacement.

- C. Place the vacuum hose over each individual media filter to suck out filter media.



Vacuuming out of media filters.

- D. Once filter media has been sucked use a pressure washer to spray down inside of the cartridge and it's containing media cages. Remove cleaned media cages and place to the side. Once removed the vacuum hose can be inserted into the cartridge to vacuum out any remaining material near the bottom of the cartridge.

- E. Reinstall media cages and fill with new media from manufacturer or outside supplier. Manufacturer will provide specification of media and sources to purchase. Utilize the manufacture provided refilling tray and place on top of cartridge. Fill tray with new bulk media and shake down into place. Using your hands slightly compact media into each filter cage. Once cages are full removed refilling tray and replace cartridge top ensuring bolts are properly tightened.



Refilling tray for media replacement.



Refilling tray on cartridge with bulk media.



- F. Exit pre-treatment chamber. Replace access hatch or manhole cover.

### 3. Biofiltration Chamber (middle vegetated chamber)

- A. In general, the biofiltration chamber is maintenance free with the exception of maintaining the vegetation. Using standard gardening tools properly trim back the vegetation to healthy levels. The MWS Linear utilizes vegetation similar to surrounding landscape areas therefore trim vegetation to match surrounding vegetation. If any plants have died replace plants with new ones:





## **Inspection Notes**

1. Following maintenance and/or inspection, it is recommended the maintenance operator prepare a maintenance/inspection record. The record should include any maintenance activities performed, amount and description of debris collected, and condition of the system and its various filter mechanisms.
2. The owner should keep maintenance/inspection record(s) for a minimum of five years from the date of maintenance. These records should be made available to the governing municipality for inspection upon request at any time.
3. Transport all debris, trash, organics and sediments to approved facility for disposal in accordance with local and state requirements.
4. Entry into chambers may require confined space training based on state and local regulations.
5. No fertilizer shall be used in the Biofiltration Chamber.
6. Irrigation should be provided as recommended by manufacturer and/or landscape architect. Amount of irrigation required is dependent on plant species. Some plants may not require irrigation after initial establishment.



## Inspection Form



Modular Wetland System, Inc.

P. 760.433-7640

F. 760-433-3176

E. [Info@modularwetlands.com](mailto:Info@modularwetlands.com)

[www.modularwetlands.com](http://www.modularwetlands.com)



# Inspection Report Modular Wetlands System



Project Name \_\_\_\_\_

Project Address \_\_\_\_\_ (city) (Zip Code)

Owner / Management Company \_\_\_\_\_

Contact \_\_\_\_\_

Phone ( ) -

Inspector Name \_\_\_\_\_

Date \_\_\_\_ / \_\_\_\_ / \_\_\_\_

Time \_\_\_\_\_ AM / PM

Type of Inspection  Routine  Follow Up  Complaint

Storm

Storm Event in Last 72-hours?  No  Yes

Weather Condition \_\_\_\_\_

Additional Notes \_\_\_\_\_

For Office Use Only

(Reviewed By)

(Date)  
Office personnel to complete section to the left.

## Inspection Checklist

Modular Wetland System Type (Curb, Grate or UG Vault): \_\_\_\_\_ Size (22', 14' or etc.): \_\_\_\_\_

Structural Integrity:	Yes	No	Comments
Damage to pre-treatment access cover (manhole cover/grate) or cannot be opened using normal lifting pressure?			
Damage to discharge chamber access cover (manhole cover/grate) or cannot be opened using normal lifting pressure?			
Does the MWS unit show signs of structural deterioration (cracks in the wall, damage to frame)?			
Is the inlet/outlet pipe or drain down pipe damaged or otherwise not functioning properly?			
<b>Working Condition:</b>			
Is there evidence of illicit discharge or excessive oil, grease, or other automobile fluids entering and clogging the unit?			
Is there standing water in inappropriate areas after a dry period?			
Is the filter insert (if applicable) at capacity and/or is there an accumulation of debris/trash on the shelf system?			
Does the depth of sediment/trash/debris suggest a blockage of the inflow pipe, bypass or cartridge filter? If yes, specify which one in the comments section. Note depth of accumulation in in pre-treatment chamber.			Depth:
Does the cartridge filter media need replacement in pre-treatment chamber and/or discharge chamber?			Chamber:
Any signs of improper functioning in the discharge chamber? Note issues in comments section.			
<b>Other Inspection Items:</b>			
Is there an accumulation of sediment/trash/debris in the wetland media (if applicable)?			
Is it evident that the plants are alive and healthy (if applicable)? Please note Plant Information below.			
Is there a septic or foul odor coming from inside the system?			

Waste:	Yes	No
Sediment / Silt / Clay		
Trash / Bags / Bottles		
Green Waste / Leaves / Foliage		

Recommended Maintenance	
No Cleaning Needed	
Schedule Maintenance as Planned	
Needs Immediate Maintenance	

Plant Information	
Damage to Plants	
Plant Replacement	
Plant Trimming	

Additional Notes: \_\_\_\_\_



## Maintenance Report



Modular Wetland System, Inc.

P. 760.433-7640

F. 760-433-3176

E. [Info@modularwetlands.com](mailto:Info@modularwetlands.com)

[www.modularwetlands.com](http://www.modularwetlands.com)





# Cleaning and Maintenance Report Modular Wetlands System



Project Name \_\_\_\_\_

Project Address \_\_\_\_\_ (city) (Zip Code)

Owner / Management Company \_\_\_\_\_

Contact \_\_\_\_\_ Phone ( ) -

Inspector Name \_\_\_\_\_ Date \_\_\_\_ / \_\_\_\_ / \_\_\_\_ Time \_\_\_\_\_ AM / PM

Type of Inspection  Routine  Follow Up  Complaint  Storm Storm Event in Last 72-hours?  No  Yes

Weather Condition \_\_\_\_\_ Additional Notes \_\_\_\_\_

For Office Use Only

---

(Reviewed By) \_\_\_\_\_

---

(Date) \_\_\_\_\_  
Office personnel to complete section to the left.

Site Map #	GPS Coordinates of Insert	Manufacturer / Description / Sizing	Trash Accumulation	Foliage Accumulation	Sediment Accumulation	Total Debris Accumulation	Condition of Media 25/50/75/100 (will be changed @ 75%)	Operational Per Manufactures' Specifications (If not, why?)
	Lat: Long:	MWS Catch Basins						
		MWS Sedimentation Basin						
		Media Filter Condition						
		Plant Condition						
		Drain Down Media Condition						
		Discharge Chamber Condition						
		Drain Down Pipe Condition						
		Inlet and Outlet Pipe Condition						

Comments:

---



---

Project Name/\_\_\_\_\_

# **ATTACHMENT 4**

## **Copy of Plan Sheets Showing Permanent Storm Water BMPs**

**Use this checklist to ensure the required information has been included on the plans:**

The plans must identify:

- Structural BMP(s) with ID numbers matching Form I-6 Summary of PDP Structural BMPs
- The grading and drainage design shown on the plans must be consistent with the delineation of DMAs shown on the DMA exhibit
- Details and specifications for construction of structural BMP(s)
- Signage indicating the location and boundary of structural BMP(s) as required by the City Engineer
- How to access the structural BMP(s) to inspect and perform maintenance
- Features that are provided to facilitate inspection (e.g., observation ports, cleanouts, silt posts, or other features that allow the inspector to view necessary components of the structural BMP and compare to maintenance thresholds)
- Manufacturer and part number for proprietary parts of structural BMP(s) when applicable
- Maintenance thresholds specific to the structural BMP(s), with a location-specific frame of reference (e.g., level of accumulated materials that triggers removal of the materials, to be identified based on viewing marks on silt posts or measured with a survey rod with respect to a fixed benchmark within the BMP)
- Recommended equipment to perform maintenance
- When applicable, necessary special training or certification requirements for inspection and maintenance personnel such as confined space entry or hazardous waste management
- Include landscaping plan sheets showing vegetation requirements for vegetated structural BMP(s)
- All BMPs must be fully dimensioned on the plans
- When proprietary BMPs are used, site specific cross section with outflow, inflow and model number shall be provided. Broucher photocopies are not allowed.

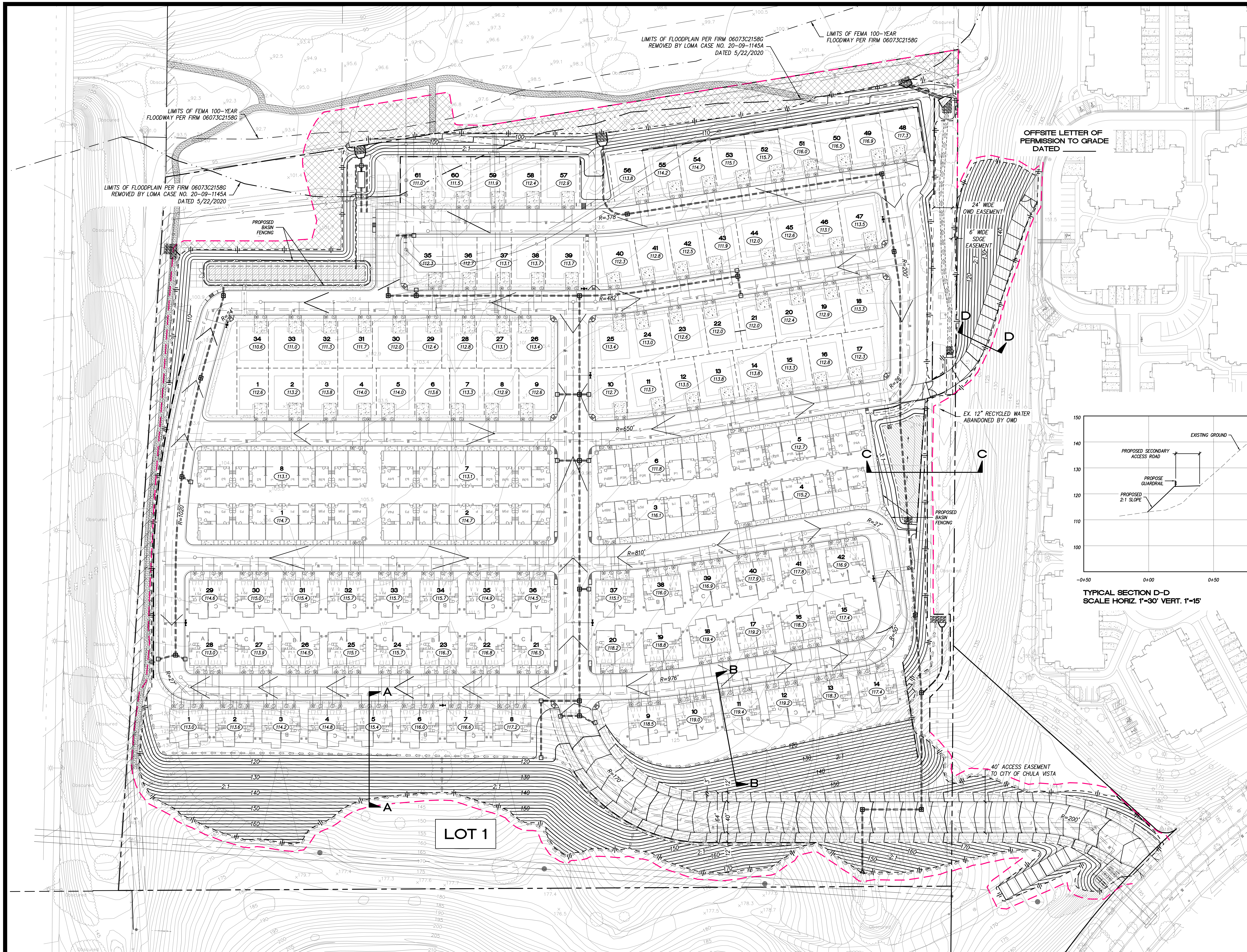

**LEGEND**

	SLOPES 2:1 MAX
	TM BOUNDARY
	PROPOSED LOT LINE
	PROPOSED DAYLIGHT LINE
	PROPOSED RETAINING WALL

**GRADING NOTES / BMP NOTES**

- BMP MAINTENANCE** - PRIOR TO THE ISSUANCE OF ANY CONSTRUCTION PERMIT, THE OWNER/PERMITEE SHALL ENTER INTO A MAINTENANCE AGREEMENT FOR THE ONGOING PERMANENT BMP MAINTENANCE, SATISFACTORY TO THE CITY ENGINEER.
- CONSTRUCTION BMP** - PRIOR TO ISSUANCE OF ANY CONSTRUCTION PERMIT, THE OWNER/PERMITEE SHALL INCORPORATE ANY CONSTRUCTION BEST MANAGEMENT PRACTICES NECESSARY TO COMPLY WITH CHAPTER 14, ARTICLE 2, DIVISION 1 (GRADING REGULATIONS) OR SAN DIEGO MUNICIPAL CODE, INTO THE CONSTRUCTION PLANS OR SPECIFICATIONS.

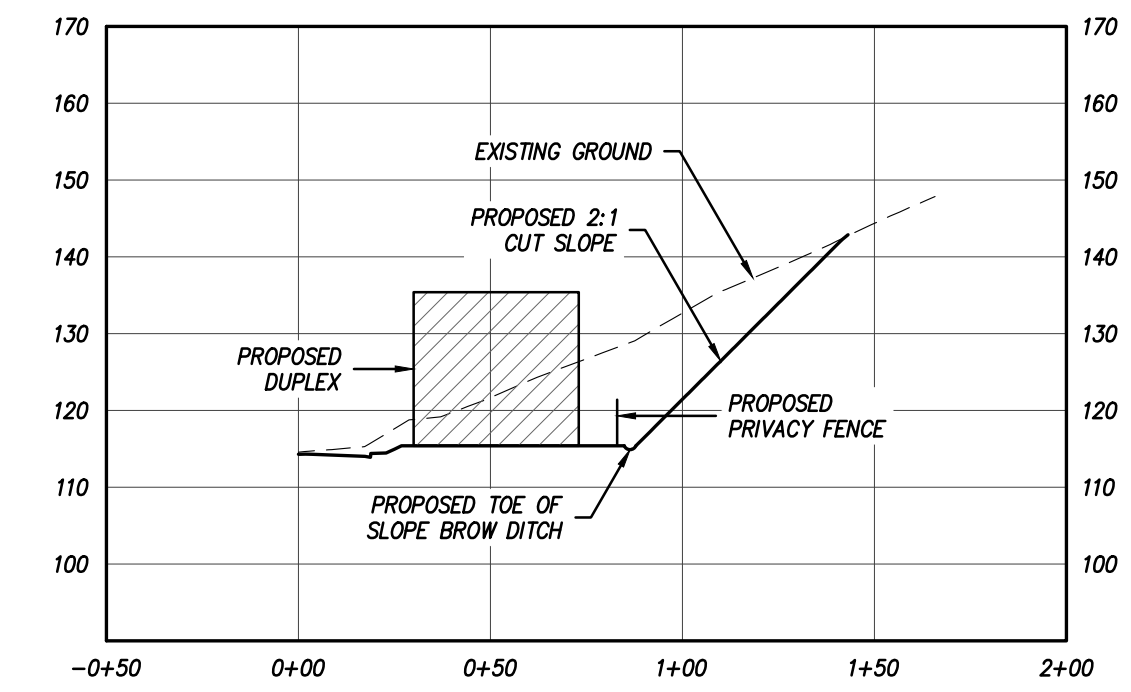

TYPICAL SECTION A-A  
SCALE HORIZ. 1"=50' VERT. 1"=25'

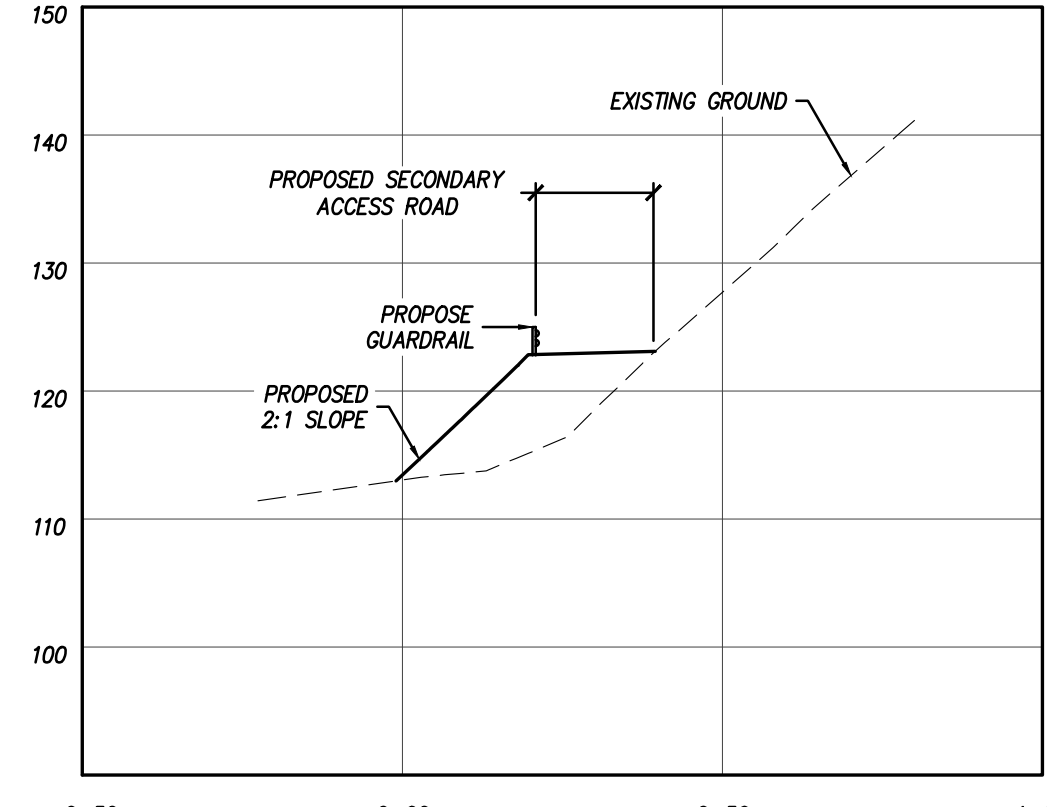

TYPICAL SECTION D-D  
SCALE HORIZ. 1"=30' VERT. 1"=15'

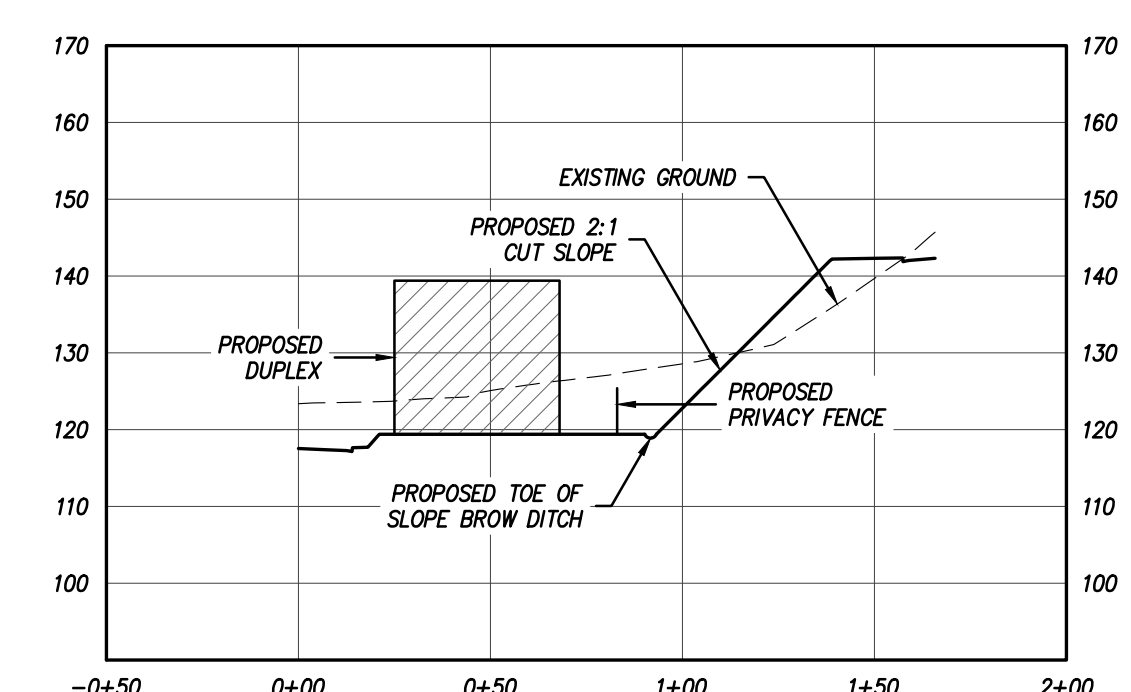

TYPICAL SECTION B-B  
SCALE HORIZ. 1"=50' VERT. 1"=25'

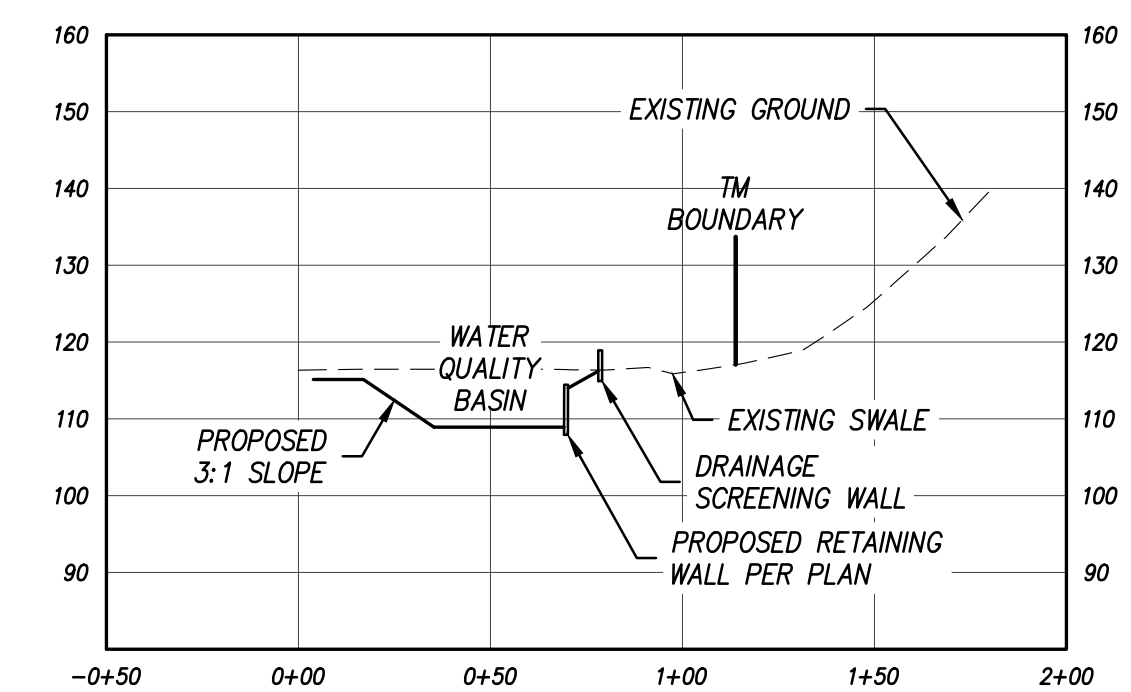

TYPICAL SECTION C-C  
SCALE HORIZ. 1"=50' VERT. 1"=25'

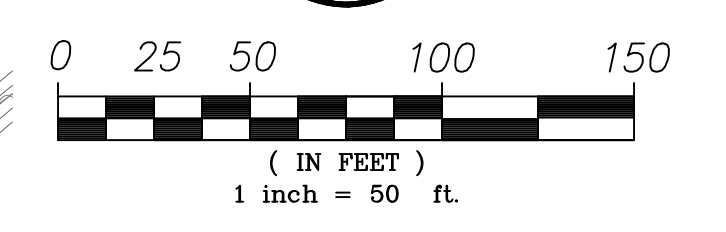
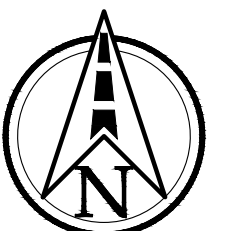

HENRY H. PENG  
R.C.E. 63686



NAME: CIVIL SENSE, INC. ADDRESS: 13475 DANIELSON STREET, SUITE 150, POWAY, CA 92128. PHONE: 858-843-4253.

PROJECT ADDRESS: NORTH-SIDE OF DENNERY RD BETWEEN REGATTA LANE AND SAND STAR WAY

PROJECT NAME: NAKANO

REVISION 12:	
REVISION 11:	
REVISION 10:	
REVISION 9:	
REVISION 8:	
REVISION 7:	
REVISION 6:	
REVISION 5:	
REVISION 4:	
REVISION 3:	11/04/2022
REVISION 2:	6/24/2022
REVISION 1:	2/17/2022

PREPARED BY: HENRY H. PENG

DATE: \_\_\_\_\_

ORIGINAL DATE: 9/15/2021

SHEET TITLE: GRADING AND STORM DRAIN

SHEET 5 OF 19

DEP # \_\_\_\_\_

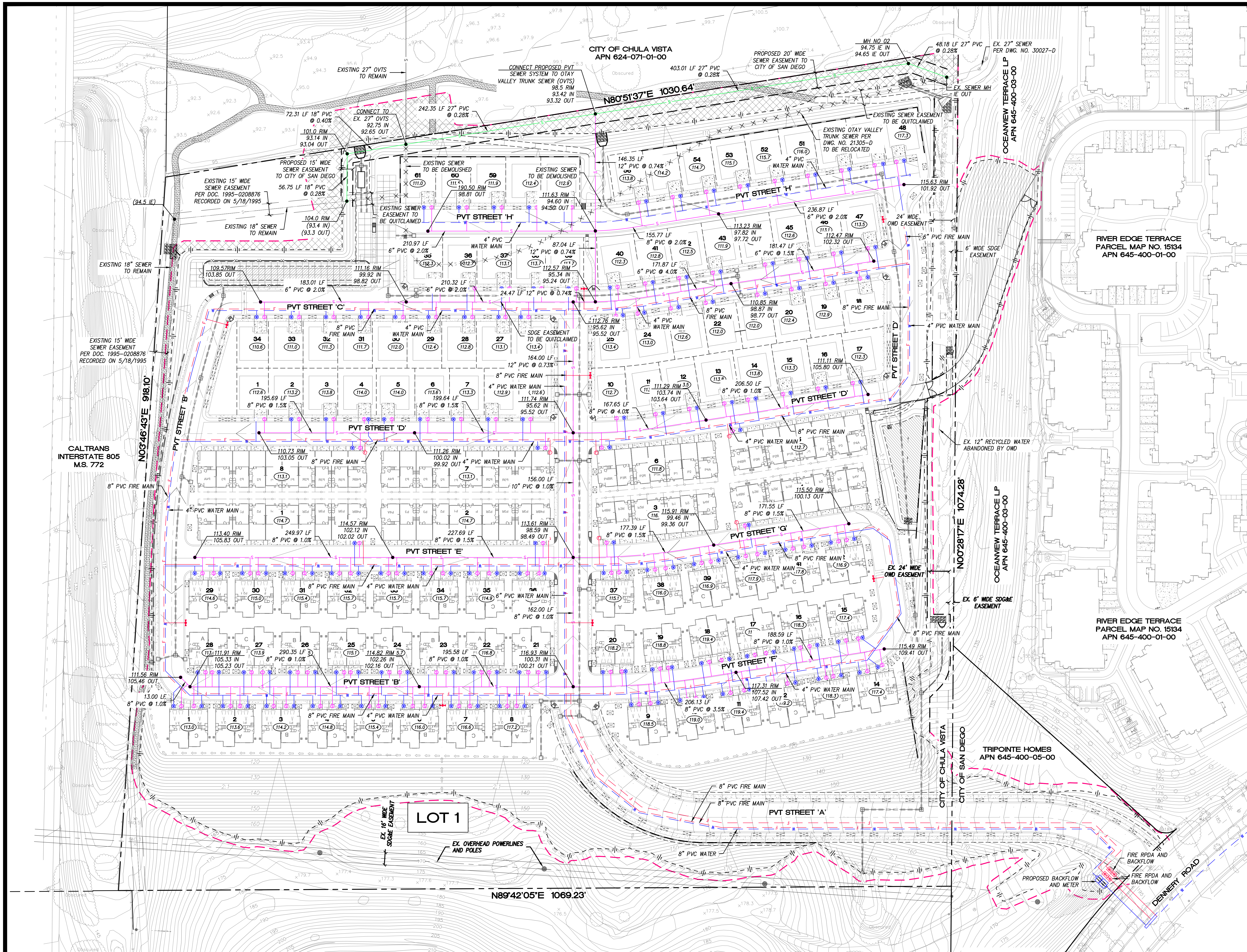

### LEGEND

- VTM BOUNDARY
- PROPOSED PRIVATE WATER MAIN (SIZE PER PLAN)
- PROPOSED PRIVATE FIRE MAIN (SIZE PER PLAN) PER NFPA PAMPHLET 24 (2016 EDITION)
- PROPOSED PRIVATE WATER SERVICE
- PROPOSED PRIVATE FIRE SERVICE PER NFPA PAMPHLET 24 (2016 EDITION)
- PROPOSED FIRE REDUCE PRESSURE DETECTOR ASSEMBLY
- PROPOSED DUAL WATER METERS AND BACK FLOW DEVICE
- PROPOSED PRIVATE SEWER AND SEWER MANHOLE
- PROPOSED PUBLIC SEWER AND SEWER MANHOLE
- PROPOSED SEWER FLOW (SLOPE PER PLAN)
- PROPOSED PRIVATE SEWER LATERAL CALIFORNIA PLUMBING CODE
- PROPOSED PRIVATE IRRIGATION SERVICE, METER, AND BACKFLOW PREVENTION DEVICE.
- PROPOSED FIRE HYDRANT
- PROPOSED 40 SF STREET TREE

NOTE: ALL SEWER, WATER, AND STORM DRAIN UTILITIES ARE PRIVATE UNLESS OTHERWISE NOTED.

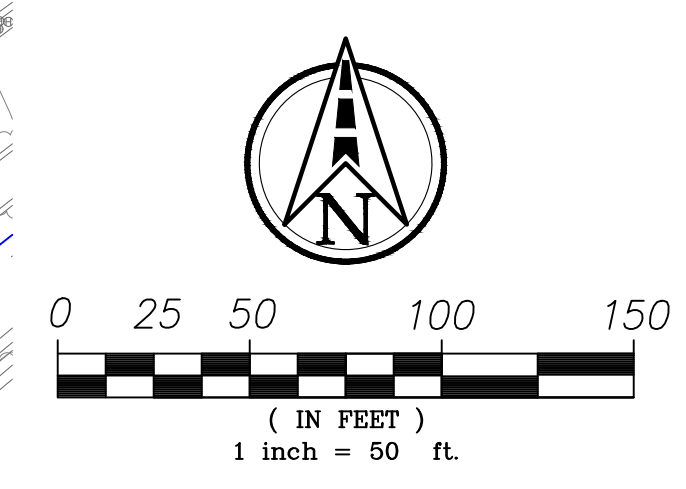

#### MINIMUM TREE SEPARATION DISTANCE

IMPROVEMENT	MIN. DISTANCE TO STREET TREE
TRAFFIC SIGNAL, STOP SIGN	20 FEET
UNDERGROUND UTILITY LINES (EXCEPT SEWER)	5 FEET
SEWER LINES	10 FEET
ABOVE GROUND UTILITY STRUCTURES (TRANSFORMERS, HYDRANTS, UTILITY POLES, ETC)	10 FEET
DRIVEWAYS	10 FEET *
INTERSECTIONS (INTERSECTING CURB LINES OF TWO STREETS)	25 FEET

\* 5 FEET ON RESIDENTIAL LOCAL STREETS WITH A DESIGN SPEED OF 25MPH OR SLOWER

#### UTILITY TABLE

UTILITY	OVERHEAD/UNDERGROUND
GAS	UNDERGROUND
ELECTRIC	UNDERGROUND
TELEPHONE (AT&T)	UNDERGROUND
CABLE TELEVISION (COX)	UNDERGROUND
SEWER	UNDERGROUND
STORM DRAIN	UNDERGROUND
FIRE	UNDERGROUND
WATER	UNDERGROUND

NOTE: THE SUBDIVIDER SHALL ENSURE THAT ALL ONSITE UTILITIES SERVING THE SUBDIVISION SHALL BE UNDERGROUNDED WITH ALL OF THE APPROPRIATE PERMITS.

- #### UTILITY NOTES
- NO TREES OR SHRUBS EXCEEDING THREE FEET IN HEIGHT AT MATURITY SHALL BE INSTALLED WITHIN TEN FEET OF ANY SEWER AND FIVE FEET OF ANY WATER FACILITIES.
  - MINIMUM 10 FOOT SEPARATION FROM SEWER MAINS TO WATER MAINS. 10 FOOT SEPARATION TO BE MEASURED FROM OUTSIDE EDGE OF PIPE TO OUTSIDE EDGE OF PIPE.
  - ALL WATER SERVICES TO THE SITE, INCLUDING DOMESTIC, IRRIGATION AND FIRE, WILL REQUIRE PRIVATE, ABOVE GROUND BACK FLOW PREVENTION DEVICES (BFPDS). BFPDS ARE TYPICALLY LOCATED ON PRIVATE PROPERTY, IN LINE WITH THE SERVICE AND IMMEDIATELY ADJACENT TO THE RIGHT-OF-WAY. THE PUBLIC UTILITIES DEPARTMENT WILL NOT PERMIT THE REQUIRED BFPDS TO BE LOCATED BELOW GRADE OR WITHIN THE STRUCTURE.
  - IF A 3" OR LARGER METER IS REQUIRED FOR THIS PROJECT, THE OWNER/PERMITEE SHALL CONSTRUCT THE NEW METER AND PRIVATE BACKFLOW DEVICE ON SITE, ABOVE GROUND, WITHIN AN ADEQUATELY SIZED WATER EASEMENT, IN A MANNER SATISFACTORY TO THE PUBLIC UTILITIES DIRECTOR AND THE CITY ENGINEER.
  - PRIOR TO THE ISSUANCE OF ANY BUILDING PERMITS, THE OWNER/PERMITEE SHALL OBTAIN AN ENCROACHMENT MAINTENANCE REMOVAL AGREEMENT, FROM THE CITY ENGINEER, FOR THE PRIVATE SEWER LATERAL IN THE STREET A RIGHT-OF-WAY.

PREPARED BY:

HENRY H. PENG  
R.C.E. 63686

DATE

NAME: CIVIL SENSE, INC.  
ADDRESS: 13475 DANIELSON STREET, SUITE 150, POWAY, CA 92128  
PHONE: 619-842-4253

PROJECT ADDRESS:  
NORTH-SIDE OF DENNERY RD BETWEEN  
REGATTA LANE AND SAND STAR WAY

PROJECT NAME:  
NAKANO

SHEET TITLE:  
UTILITY PLAN

REVISION 12: \_\_\_\_\_  
REVISION 11: \_\_\_\_\_  
REVISION 10: \_\_\_\_\_  
REVISION 9: \_\_\_\_\_  
REVISION 8: \_\_\_\_\_  
REVISION 7: \_\_\_\_\_  
REVISION 6: \_\_\_\_\_  
REVISION 5: \_\_\_\_\_  
REVISION 4: \_\_\_\_\_  
REVISION 3: 11/04/2022  
REVISION 2: 6/24/2022  
REVISION 1: 2/17/2022

ORIGINAL DATE: 9/15/2021

SHEET 6 OF 19

DEP # \_\_\_\_\_



A Forterra Company

# Modular Wetlands<sup>®</sup> System Linear

A Stormwater Biofiltration Solution



# OVERVIEW

The Bio Clean Modular Wetlands® System Linear represents a pioneering breakthrough in stormwater technology as the only biofiltration system to utilize patented horizontal flow, allowing for a smaller footprint, higher treatment capacity, and a wide range of versatility. While most biofilters use little or no pretreatment, the Modular Wetlands® incorporates an advanced pretreatment chamber that includes separation and pre-filter cartridges. In this chamber, sediment and hydrocarbons are removed from runoff before entering the biofiltration chamber, reducing maintenance costs and improving performance.

Horizontal flow also gives the system the unique ability to adapt to the environment through a variety of configurations, bypass orientations, and diversion applications.

## The Urban Impact

For hundreds of years, natural wetlands surrounding our shores have played an integral role as nature's stormwater treatment system. But as cities grow and develop, our environment's natural filtration systems are blanketed with impervious roads, rooftops, and parking lots.

Bio Clean understands this loss and has spent years re-establishing nature's presence in urban areas, and rejuvenating waterways with the Modular Wetlands® System Linear.

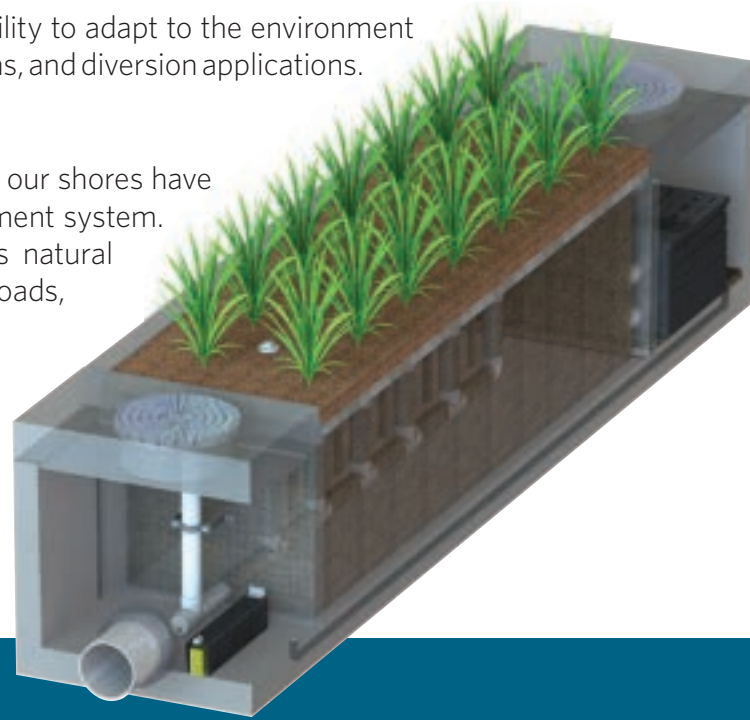

# PERFORMANCE

The Modular Wetlands® continues to outperform other treatment methods with superior pollutant removal for TSS, heavy metals, nutrients, hydrocarbons, and bacteria. Since 2007 the Modular Wetlands® has been field tested on numerous sites across the country and is proven to effectively remove pollutants through a combination of physical, chemical, and biological filtration processes. In fact, the Modular Wetlands® harnesses some of the same biological processes found in natural wetlands in order to collect, transform, and remove even the most harmful pollutants.

<b>66%</b> REMOVAL OF DISSOLVED ZINC	<b>69%</b> REMOVAL OF TOTAL ZINC	<b>38%</b> REMOVAL OF DISSOLVED COPPER	<b>64%</b> REMOVAL OF TOTAL PHOSPHORUS	
<b>45%</b> REMOVAL OF NITROGEN	<b>50%</b> REMOVAL OF TOTAL COPPER	<b>95%</b> REMOVAL OF MOTOR OIL	<b>67%</b> REMOVAL OF ORTHO PHOSPHORUS	<b>85%</b> REMOVAL OF TSS

# APPROVALS

The Modular Wetlands® System Linear has successfully met years of challenging technical reviews and testing from some of the most prestigious and demanding agencies in the nation and perhaps the world. Here is a list of some of the most high-profile approvals, certifications, and verifications from around the country.

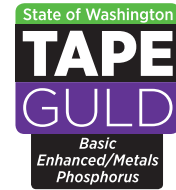

## Washington State Department of Ecology TAPE Approved

The MWS Linear is approved for General Use Level Designation (GULD) for Basic, Enhanced, and Phosphorus treatment at 1 gpm/ft<sup>2</sup> loading rate. The highest performing BMP on the market for all main pollutant categories.



## California Water Resources Control Board, Full Capture Certification

The Modular Wetlands® System is the first biofiltration system to receive certification as a full capture trash treatment control device.



## Virginia Department of Environmental Quality, Assignment

The Virginia Department of Environmental Quality assigned the MWS Linear the highest phosphorus removal rating for manufactured treatment devices to meet the new Virginia Stormwater Management Program (VSMP) regulation technical criteria.



## Maryland Department of the Environment, Approved ESD

Granted Environmental Site Design (ESD) status for new construction, redevelopment, and retrofitting when designed in accordance with the design manual.



## MASTEP Evaluation

The University of Massachusetts at Amherst - Water Resources Research Center issued a technical evaluation report noting removal rates up to 84% TSS, 70% total phosphorus, 68.5% total zinc, and more.



## Rhode Island Department of Environmental Management, Approved BMP

Approved as an authorized BMP and noted to achieve the following minimum removal efficiencies: 85% TSS, 60% pathogens, 30% total phosphorus, and 30% total nitrogen.

# ADVANTAGES

- HORIZONTAL FLOW BIOFILTRATION
- GREATER FILTER SURFACE AREA
- PRETREATMENT CHAMBER
- PATENTED PERIMETER VOID AREA
- FLOW CONTROL
- NO DEPRESSED PLANTER AREA
- AUTO DRAINDOWN MEANS NO MOSQUITO VECTOR

# OPERATION

The Modular Wetlands® System Linear is the most efficient and versatile biofiltration system on the market, and it is the only system with horizontal flow which:

- Improves performance
- Reduces footprint
- Minimizes maintenance

Figure 1 & Figure 2 illustrate the invaluable benefits of horizontal flow and the multiple treatment stages.

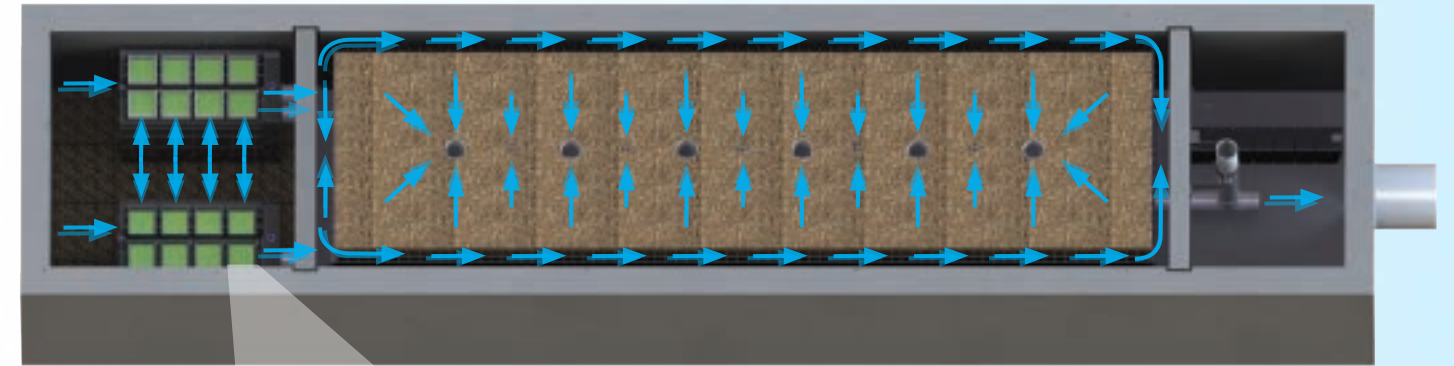

Figure 2,  
Top View

2x to 3x more surface area than traditional downward flow bioretention systems.

## 1 PRETREATMENT

### SEPARATION

- Trash, sediment, and debris are separated before entering the pre-filter cartridges
- Designed for easy maintenance access

### PRE-FILTER CARTRIDGES

- Over 25 sq. ft. of surface area per cartridge
- Utilizes BioMediaGREEN™ filter material
- Removes over 80% of TSS and 90% of hydrocarbons
- Prevents pollutants that cause clogging from migrating to the biofiltration chamber

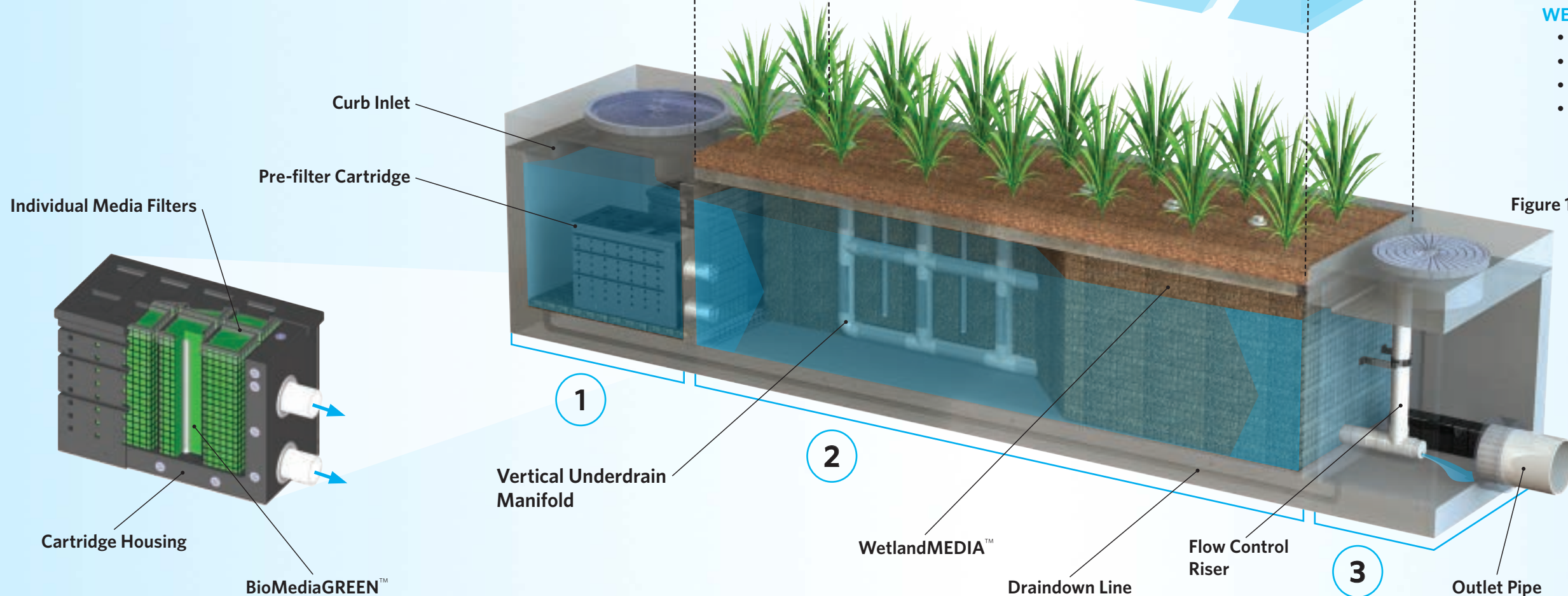

Figure 1

## 2 BIOFILTRATION

### HORIZONTAL FLOW

- Less clogging than downward flow biofilters
- Water flow is subsurface
- Improves biological filtration

### PATENTED PERIMETER VOID AREA

- Vertically extends void area between the walls and the WetlandMEDIA™ on all four sides
- Maximizes surface area of the media for higher treatment capacity

### WETLANDMEDIA

- Contains no organics and removes phosphorus
- Greater surface area and 48% void space
- Maximum evapotranspiration
- High ion exchange capacity and lightweight

## 3 DISCHARGE

### FLOW CONTROL

- Orifice plate controls flow of water through WetlandMEDIA™ to a level lower than the media's capacity
- Extends the life of the media and improves performance

### DRAINDOWN FILTER

- The draindown is an optional feature that completely drains the pretreatment chamber
- Water that drains from the pretreatment chamber between storm events will be treated





# CONFIGURATIONS

The Modular Wetlands® System Linear is the preferred biofiltration system of civil engineers across the country due to its versatile design. This highly versatile system has available “pipe-in” options on most models, along with built-in curb or grated inlets for simple integration into your storm drain design.



## CURB TYPE

The Curb Type configuration accepts sheet flow through a curb opening and is commonly used along roadways and parking lots. It can be used in sump or flow-by conditions. Length of curb opening varies based on model and size.

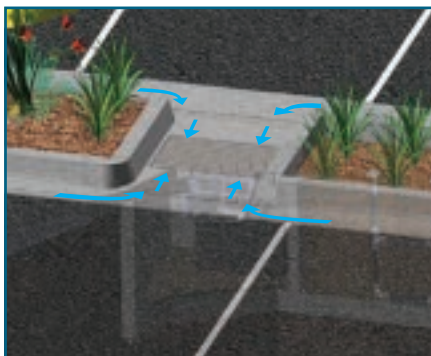

## GRATE TYPE

The Grate Type configuration offers the same features and benefits as the Curb Type but with a grated/drop inlet above the systems pretreatment chamber. It has the added benefit of allowing pedestrian access over the inlet. ADA-compliant grates are available to assure easy and safe access. The Grate Type can also be used in scenarios where runoff needs to be intercepted on both sides of landscape islands.

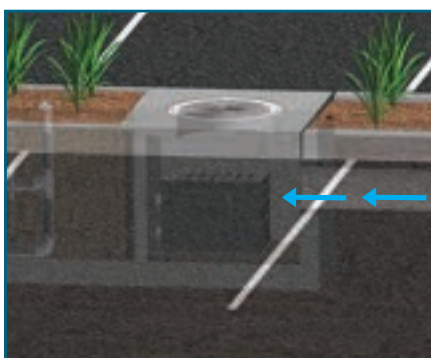

## VAULT TYPE

The system’s patented horizontal flow biofilter is able to accept inflow pipes directly into the pretreatment chamber, meaning the Modular Wetlands® can be used in end-of-the-line installations. This greatly improves feasibility over typical decentralized designs that are required with other biofiltration/bioretenion systems. Another benefit of the “pipe-in” design is the ability to install the system downstream of underground detention systems to meet water quality volume requirements.



## DOWNSPOUT TYPE

The Downspout Type is a variation of the Vault Type and is designed to accept a vertical downspout pipe from rooftop and podium areas. Some models have the option of utilizing an internal bypass, simplifying the overall design. The system can be installed as a raised planter, and the exterior can be stuccoed or covered with other finishes to match the look of adjacent buildings.

# ORIENTATIONS

## SIDE-BY-SIDE

The Side-By-Side orientation places the pretreatment and discharge chamber adjacent to one another with the biofiltration chamber running parallel on either side. This minimizes the system length, providing a highly compact footprint. It has been proven useful in situations such as streets with directly adjacent sidewalks, as half of the system can be placed under that sidewalk. This orientation also offers internal bypass options as discussed below.



## END-TO-END

The End-To-End orientation places the pretreatment and discharge chambers on opposite ends of the biofiltration chamber, therefore minimizing the width of the system to 5 ft. (outside dimension). This orientation is perfect for linear projects and street retrofits where existing utilities and sidewalks limit the amount of space available for installation. One limitation of this orientation is that bypass must be external.

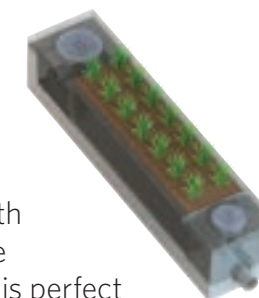

# BYPASS

## INTERNAL BYPASS WEIR (SIDE-BY-SIDE ONLY)

The Side-By-Side orientation places the pretreatment and discharge chambers adjacent to one another allowing for integration of internal bypass. The wall between these chambers can act as a bypass weir when flows exceed the system’s treatment capacity, thus allowing bypass from the pretreatment chamber directly to the discharge chamber.

## EXTERNAL DIVERSION WEIR STRUCTURE

This traditional offline diversion method can be used with the Modular Wetlands® in scenarios where runoff is being piped to the system. These simple and effective structures are generally configured with two outflow pipes. The first is a smaller pipe on the upstream side of the diversion weir - to divert low flows over to the Modular Wetlands® for treatment. The second is the main pipe that receives water once the system has exceeded treatment capacity and water flows over the weir.

## FLOW-BY-DESIGN

This method is one in which the system is placed just upstream of a standard curb or grate inlet to intercept the first flush. Higher flows simply pass by the Modular Wetlands® and into the standard inlet downstream.

## DVERT LOW FLOW DIVERSION

This simple yet innovative diversion trough can be installed in existing or new curb and grate inlets to divert the first flush to the Modular Wetlands® via pipe. It works similar to a rain gutter and is installed just below the opening into the inlet. It captures the low flows and channels them over

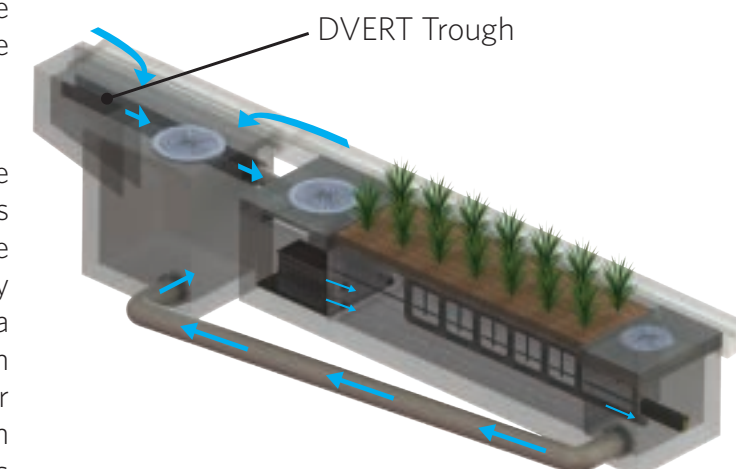

to a connecting pipe exiting out the wall of the inlet and leading to the MWS Linear. The DVERT is perfect for retrofit and green street applications that allow the Modular Wetlands® to be installed anywhere space is available.

# SPECIFICATIONS

## FLOW-BASED DESIGNS

The Modular Wetlands® System Linear can be used in stand-alone applications to meet treatment flow requirements. Since the Modular Wetlands® is the only biofiltration system that can accept inflow pipes several feet below the surface, it can be used not only in decentralized design applications but also as a large central end-of-the-line application for maximum feasibility.

MODEL #	DIMENSIONS	WETLAND MEDIA SURFACE AREA (sq. ft.)	TREATMENT FLOW RATE (cfs)
MWS-L-4-4	4' x 4'	23	0.052
MWS-L-4-6	4' x 6'	32	0.073
MWS-L-4-8	4' x 8'	50	0.115
MWS-L-4-13	4' x 13'	63	0.144
MWS-L-4-15	4' x 15'	76	0.175
MWS-L-4-17	4' x 17'	90	0.206
MWS-L-4-19	4' x 19'	103	0.237
MWS-L-4-21	4' x 21'	117	0.268
MWS-L-6-8	7' x 9'	64	0.147
MWS-L-8-8	8' x 8'	100	0.230
MWS-L-8-12	8' x 12'	151	0.346
MWS-L-8-16	8' x 16'	201	0.462
MWS-L-8-20	9' x 21'	252	0.577
MWS-L-8-24	9' x 25'	302	0.693
MWS-L-10-20	10' x 20'	302	0.693

# VOLUME-BASED DESIGNS

## HORIZONTAL FLOW BIOFILTRATION ADVANTAGE



Modular Wetlands® with Box Culvert Prestorage

The Modular Wetlands® System Linear offers a unique advantage in the world of biofiltration due to its exclusive horizontal flow design: Volume-Based Design. No other biofilter has the ability to be placed downstream of detention ponds, extended dry detention basins, underground storage systems and permeable paver reservoirs. The systems horizontal flow configuration and built-in orifice control allows it to be installed with just 6" of fall between inlet and outlet pipe for a simple connection to projects with shallow downstream tie-in points. In the example above, the Modular Wetlands® is installed downstream of underground box culvert storage. Designed for the water quality volume, the Modular Wetlands® will treat and discharge the required volume within local draindown time requirements.

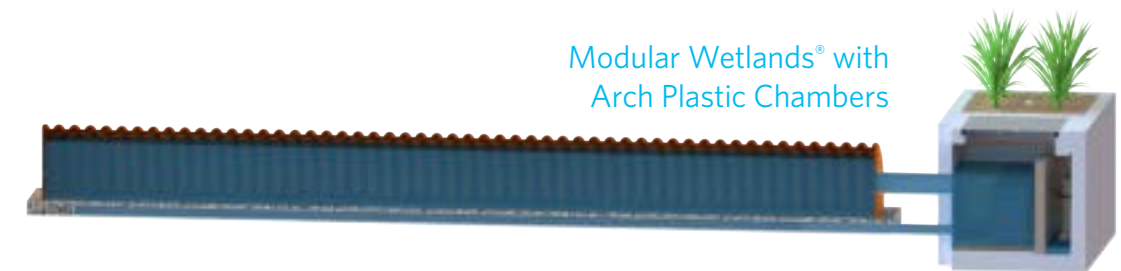

Modular Wetlands® with Arch Plastic Chambers

### DESIGN SUPPORT

Bio Clean engineers are trained to provide you with superior support for all volume sizing configurations throughout the country. Our vast knowledge of state and local regulations allow us to quickly and efficiently size a system to maximize feasibility. Volume control and hydromodification regulations are expanding the need to decrease the cost and size of your biofiltration system. Bio Clean will help you realize these cost savings with the Modular Wetlands®, the only biofilter than can be used downstream of storage BMPs.

## ADVANTAGES

- LOWER COST THAN FLOW-BASED DESIGN
- BUILT-IN ORIFICE CONTROL STRUCTURE
- MEETS LID REQUIREMENTS
- WORKS WITH DEEP INSTALLATIONS

# APPLICATIONS

The Modular Wetlands® System Linear has been successfully used on numerous new construction and retrofit projects. The system's superior versatility makes it beneficial for a wide range of stormwater and waste water applications - treating rooftops, streetscapes, parking lots, and industrial sites.



## INDUSTRIAL

Many states enforce strict regulations for discharges from industrial sites. The Modular Wetlands® has helped various sites meet difficult EPA-mandated effluent limits for dissolved metals and other pollutants.



## STREETS

Street applications can be challenging due to limited space. The Modular Wetlands® is very adaptable, and it offers the smallest footprint to work around the constraints of existing utilities on retrofit projects.



## COMMERCIAL

Compared to bioretention systems, the Modular Wetlands® can treat far more area in less space, meeting treatment and volume control requirements.



## RESIDENTIAL

Low to high density developments can benefit from the versatile design of the Modular Wetlands®. The system can be used in both decentralized LID design and cost-effective end-of-the-line configurations.



## PARKING LOTS

Parking lots are designed to maximize space and the Modular Wetlands® 4 ft. standard planter width allows for easy integration into parking lot islands and other landscape medians.



## MIXED USE

The Modular Wetlands® can be installed as a raised planter to treat runoff from rooftops or patios, making it perfect for sustainable "live-work" spaces.

### More applications include:

- Agriculture
- Reuse
- Low Impact Development
- Waste Water

# PLANT SELECTION

Abundant plants, trees, and grasses bring value and an aesthetic benefit to any urban setting, but those in the Modular Wetlands® System Linear do even more - they increase pollutant removal. What's not seen, but very important, is that below grade, the stormwater runoff/flow is being subjected to nature's secret weapon: a dynamic physical, chemical, and biological process working to break down and remove non-point source pollutants. The flow rate is controlled in the Modular Wetlands®, giving the plants more contact time so that pollutants are more successfully decomposed, volatilized, and incorporated into the biomass of the Modular Wetlands'® micro/macro flora and fauna.



A wide range of plants are suitable for use in the Modular Wetlands®, but selections vary by location and climate. View suitable plants by visiting [biocleanenvironmental.com/plants](http://biocleanenvironmental.com/plants).

# INSTALLATION



The Modular Wetlands® is simple, easy to install, and has a space-efficient design that offers lower excavation and installation costs compared to traditional tree-box type systems. The structure of the system resembles precast catch basin or utility vaults and is installed in a similar fashion.

The system is delivered fully assembled for quick installation. Generally, the structure can be unloaded and set in place in 15 minutes. Our experienced team of field technicians is available to supervise installations and provide technical support.

# MAINTENANCE



Reduce your maintenance costs, man hours, and materials with the Modular Wetlands®. Unlike other biofiltration systems that provide no pretreatment, the Modular Wetlands® is a self-contained treatment train which incorporates simple and effective pretreatment.

Maintenance requirements for the biofilter itself are almost completely eliminated, as the pretreatment chamber removes and isolates trash, sediments, and hydrocarbons. What's left is the simple maintenance of an easily accessible pretreatment chamber that can be cleaned by hand or with a standard vac truck. Only periodic replacement of low-cost media in the pre-filter cartridges is required for long-term operation, and there is absolutely no need to replace expensive biofiltration media.



5796 Armada Drive Suite 250  
Carlsbad, CA 92008  
855.566.3938  
stormwater@forterrabp.com  
biocleanenvironmental.com

Project Name/\_\_\_\_\_

# ATTACHMENT 5

## Drainage Report

Attach project's drainage report. Refer to the Subdivision Manual to determine the reporting requirements.

# PRELIMINARY DRAINAGE REPORT

## NAKANO

**City of Chula Vista, CA**

**November 3, 2022**

City of Chula Vista TM#PCS21-0001,  
City of San Diego PTS 647766

APN #: 624-071-02

Project Address:

North of the intersection of Dennery Rd & Regatta Lane, Chula Vista,  
CA 92154

Prepared For:

**TriPointe Homes**

13400 Sabre Springs Parkway, Suite 200  
San Diego, CA 92128

Prepared By:



**PROJECT DESIGN CONSULTANTS**

Planning | Landscape Architecture | Engineering | Survey

701 B Street, Suite 800  
San Diego, CA 92101  
619.235.6471 Tel  
619.234.0349 Fax

PDC Job No. 4409.02



Prepared by: J.Novoa, PE  
*Under the supervision of*

---

Chelisa A. Pack, PE RCE 71026  
Registration Expires 6/30/23

# TABLE OF CONTENTS

1.	INTRODUCTION .....	1
2.	EXISTING AND PROPOSED DRAINAGE PATTERNS AND IMPROVEMENTS.....	2
2.1	Existing Drainage Patterns.....	2
2.2	Proposed Drainage Improvements .....	3
3.	HYDROLOGY CRITERIA, METHODOLOGY, AND RESULTS.....	3
3.1	Hydrology Criteria.....	4
3.2	Hydrologic Methodology.....	4
3.3	Description of Hydrologic Modeling Software .....	5
3.4	Hydrology Results .....	5
4.	HYDRAULIC CRITERIA, METHODOLOGY, AND RESULTS .....	6
5.	DETENTION.....	6
6.	FEMA LETTER OF MAP AMENDMENT.....	6
7.	CONCLUSION.....	7

## TABLES

Table 1:	Hydrology Criteria.....	4
Table 2:	Hydrology Results .....	5

## APPENDICES

1	Supplemental Information (Intensity Duration Frequency Curve, Runoff Coefficients)
2	Existing Conditions Rational Method Computer Output
3	Proposed Conditions Rational Method Computer Output
4	Hydraulic Calculations
5	Preliminary Detention Calculations
6	Drainage Exhibits
7	LOMA

## 1. INTRODUCTION

This drainage report has been prepared in support of the preliminary design of the proposed storm drain improvements associated with the Nakano development project (Project) for a Tentative Map(TM) submittal. The Nakano Project is a development project on a previously graded site which will consist of a combination of detached condominiums, duplexes and multi-family dwelling units for residential use. Total Project area is 23.8 acres that is currently a vacant lot. The project is located south of Otay River, and is bounded on the south by a Kaiser Permanente building and hillside, on the east by existing residential homes and on the west by I-805 freeway. The project proposes a total of 61 detached condominiums, 84 duplexes, and 70 multi-family dwelling units. The project is currently within the City of Chula Vista jurisdiction, but may be annexed into the City of San Diego before development. Refer to the Vicinity Map below: Figure 1 for the Project location.

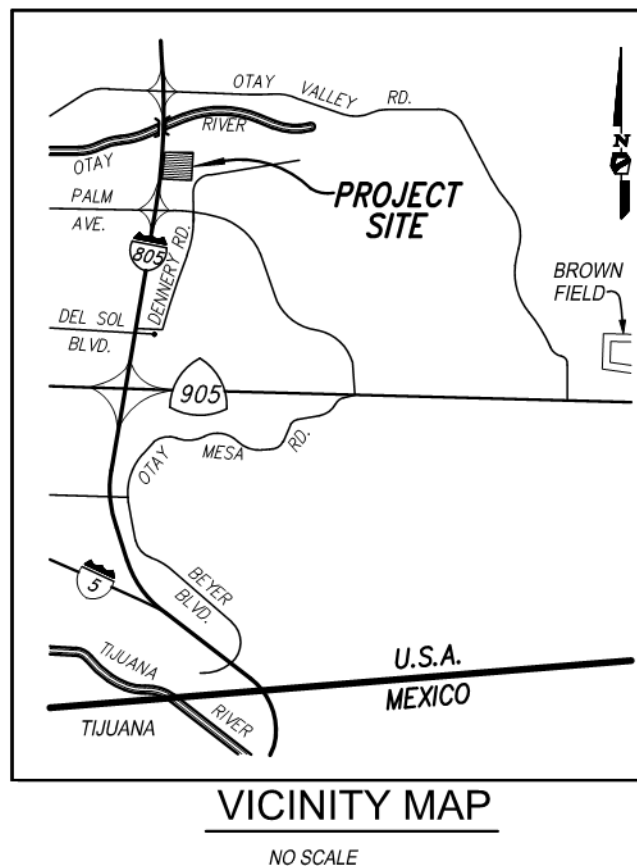

**Figure 1: Vicinity Map**



At present the site is mostly undeveloped land consisting primarily of natural terrain, with brush and some areas of larger trees along the existing channel going through project site from south to north along the eastern edge of the property carrying mostly runoff from the south.

Presently all runoff flows across the site from south to north, and then sheet flows towards the Otay River. The proposed project will continue to send all runoff to the north with a proposed upgraded storm drain that will be constructed to convey water from the site to downstream. The eastern existing flowpath will mostly be preserved and a low flow splitter will be constructed to maintain low flows through this existing area, while the high flows will be piped through the site to the north center outlet. Two biofiltration basins and a Modular Wetland Unit with a detention vault will be implemented to manage water quality while also providing some peak flow detention. From a regional drainage perspective, the runoff through the Project site includes 10.1 acres of upstream offsite area immediately south to the project boundary. The western side of offsite upstream areas drain through the site and along the western edge. The proposed site's storm drain system will outlet into the existing terrain along the north end of the project, and runoff will sheet flow towards the Otay River, which eventually drains into the San Diego Bay. For water quality management concerns refer to the Storm Water Quality Management Plan (SWQMP) prepared by Project Design Consultants for the proposed project treatment BMPs. The project will require an a 401 and 404 permit as well as CA DFW 1602 permit.

## **2. EXISTING AND PROPOSED DRAINAGE PATTERNS AND IMPROVEMENTS**

The following sections provide descriptions of the existing and proposed drainage patterns and improvements for the project.

### **2.1 Existing Drainage Patterns**

There are minimal on-site drainage facilities, except for an existing natural channel along the eastern edge of the property. At present, the majority of the site runoff flows via sheet flow to the north. Upstream of the site, runoff from areas including hillside and a Kaiser Permanente building flow through and along the eastern and western edges of the project site. There is an existing channel along the eastern side of the project that runs along the edge of the property boundary. Refer to Exhibit A in Appendix 6 for the existing condition drainage map.

## **2.2 Proposed Drainage Improvements**

The site will continue to discharge to north with brow ditches and piped storm drain to convey the runoff. The project site will include a private storm drain system to convey the onsite flow. The eastern runoff will enter a new RCP storm drain pipe and will take the high flows through the site to outletting the north center outfall of the project. A low flow splitter will be constructed to maintain flow through the existing flowpath. A small wall parallel to the biofiltration basin will be installed to ensure the runoff flow does not enter the project site. This area was designed to not commingle the upstream runoff and allow a portion of the channel to remain natural. The proposed drainage improvements include private storm drains collecting rooftop and surface drainage. Refer to Exhibit B in Appendix 6 for the proposed condition drainage map.

Water quality requirements will be managed with two biofiltration basins and a detention vault upstream of a modular wetland unit. The detention vault will provide peak flow detention to mitigate for peak flows.

## **3. HYDROLOGY CRITERIA, METHODOLOGY, AND RESULTS**

Hydrologic modeling was performed per City of Chula Vista Subdivision Manual criteria to provide the design flows for storm drain design and improvements.

### 3.1 Hydrology Criteria

Table 1 summarizes the hydrology assumptions and criteria used for hydrologic modeling.

**Table 1: Hydrology Criteria**

Existing and Proposed Hydrology:	100-year storm frequency
Soil Type:	Hydrologic Soil Group C & D
Land Use / Runoff Coefficients:	Based on criteria presented in the <u>Revised 2012 City of Chula Vista Subdivision Manual Section 3-200 Hydrology/Drainage/Urban Runoff</u> .
Rainfall intensity:	Based on intensity duration frequency relationships presented in the <u>2017 Chula Vista Design Standards &amp; Revised 2012 City of Chula Vista Subdivision Manual Section 3-200 Hydrology/Drainage/Urban Runoff</u> , see Appendix 1 .

### 3.2 Hydrologic Methodology

The Rational Method was used to determine the onsite 100-year storm flow for the design of the Project storm drainpipe improvements. The goal of this analysis was to:

- Determine the design flows for the sizing of any proposed storm drain improvements.
- Determine the differences in the drainage conditions between existing and proposed conditions to confirm there are no significant downstream impacts.

The AES Modified Rational Method program was used to calculate onsite and offsite runoff for the 100-year storm event. The runoff coefficient for hillsides depended on the steepness and ranged from 0.45-0.6, which were used for the existing onsite conditions while higher runoff coefficients for normal residential development, dense residential, and paved surfaces were used for the proposed onsite condition. Offsite hydrology runoff coefficients were based on land uses apparent from aerial photography, which includes vegetated slopes (Flat, Rolling, Hilly and Steep depending on the slope %).

### 3.3 Description of Hydrologic Modeling Software

The Modified Rational Method was used to determine the 100-year storm flow for the design of the storm system. The Advanced Engineering Software (AES) Rational Method Program was used to perform the hydrologic calculations. This section provides a brief explanation of the computational procedure used in the computer model.

The AES Modified Rational Method Hydrology Program is a computer-aided design program where the user develops a node link model of the watershed. Developing independent node link models for each interior watershed and linking these sub-models together at confluence points creates the node link model. The intensity-duration-frequency relationships are applied to each of the drainage areas in the model to get the peak flow rates at each point of interest.

### 3.4 Hydrology Results

The Rational Method as presented in the City of Chula Vista Subdivision Manual and County of San Diego Hydrology Manual was used to calculate the existing and proposed conditions peak storm flows. Table 2 below summarizes the Rational Method results for the comparison of the existing and proposed project site.

**Table 2: Hydrology Results**

NAKANO HYDROLOGY SUMMARY								
OUTFALL OF INTEREST	EXISTING CONDITION				PROPOSED CONDITION (WITH DETENTION)			
	SYSTEM	AREA (ac)	TC (min)	Q100 (cfs)	SYSTEM	AREA (ac)	TC (min)	Q100 (cfs)
# 1	100	15.8	9.98	50.2	System 1100(including Sys 1000)	16.3	13.41	42.8 (Undetained) 14.2 (Detained)
					1200	16.3		51.9
	130	18.9	11.86	33.4	1300	2.7	10.43	6.5
	160	3.5	10.17	7.9	1600	3.3	9.60	7.7
	<b>TOTAL</b>	<b>38.2</b>		<b>91.5</b>	<b>TOTAL</b>	<b>38.6</b>		<b>80.3</b>
	<b>GRAND TOTAL</b>	<b>38.2</b>		<b>91.5</b>	<b>GRAND TOTAL</b>	<b>38.6</b>		<b>80.3</b>

The site will detain post-project 100-year flows to less than pre-project 100-year flows. Final detention routing will be provided during final engineering, however, preliminary calculations are provided in Appendix 5.

#### **4. HYDRAULIC CRITERIA, METHODOLOGY, AND RESULTS**

Hydraulic calculations for pipes, inlets, and ditches will be performed during final engineering.

#### **5. DETENTION**

The vault was sized to attenuate post-project peak flow rates to pre-project levels for the 100-year storm event and water quality pollutant control. By including the north vault for detention, the post-project peak flows will be able to be reduced to below pre-project levels. Detention results from routing the basin outflow hydrographs will be included during final engineering.

#### **6. FEMA LETTER OF MAP AMENDMENT**

A Letter of Map Amendment (LOMA) was performed and certified that the existing property elevations within the Nakano project are above the Zone AE special flood hazard area base flood elevations for the Otay River. The entire property was removed from the 100-year floodplain limits. See Appendix 7 for FEMA approval letter for the LOMA.

The LOMA (Case Reference #20-09-1145A) demonstrated that the existing elevations of the Nakano property are above the flood elevations indicated by Zone AE as shown in the FIRM Panel No. 06073C2158G, effective date May 16, 2012. The Zone AE floodplain extends along the north portion of the site with water surface elevations ranging from 83.8 to 92.7 ft. MSL (NGVD 29). Note that there a 2.17 conversion from NAVD88 to NGVD29 datum.

## **7. CONCLUSION**

This drainage report has been prepared in support of the preliminary design of the storm drain improvements for the Tentative Map for the Nakano project. The purpose of this report is to provide peak discharges for use in designing the private storm drain systems for the project and to address issues regarding comparing the post-project flows to the pre-project flows. The storm drain system will be sufficient to satisfy City of Chula Vista criteria in the post-development condition.

## **APPENDIX 1**

### **Supplemental Information (Intensity Duration Frequency Curve, Runoff Coefficients)**

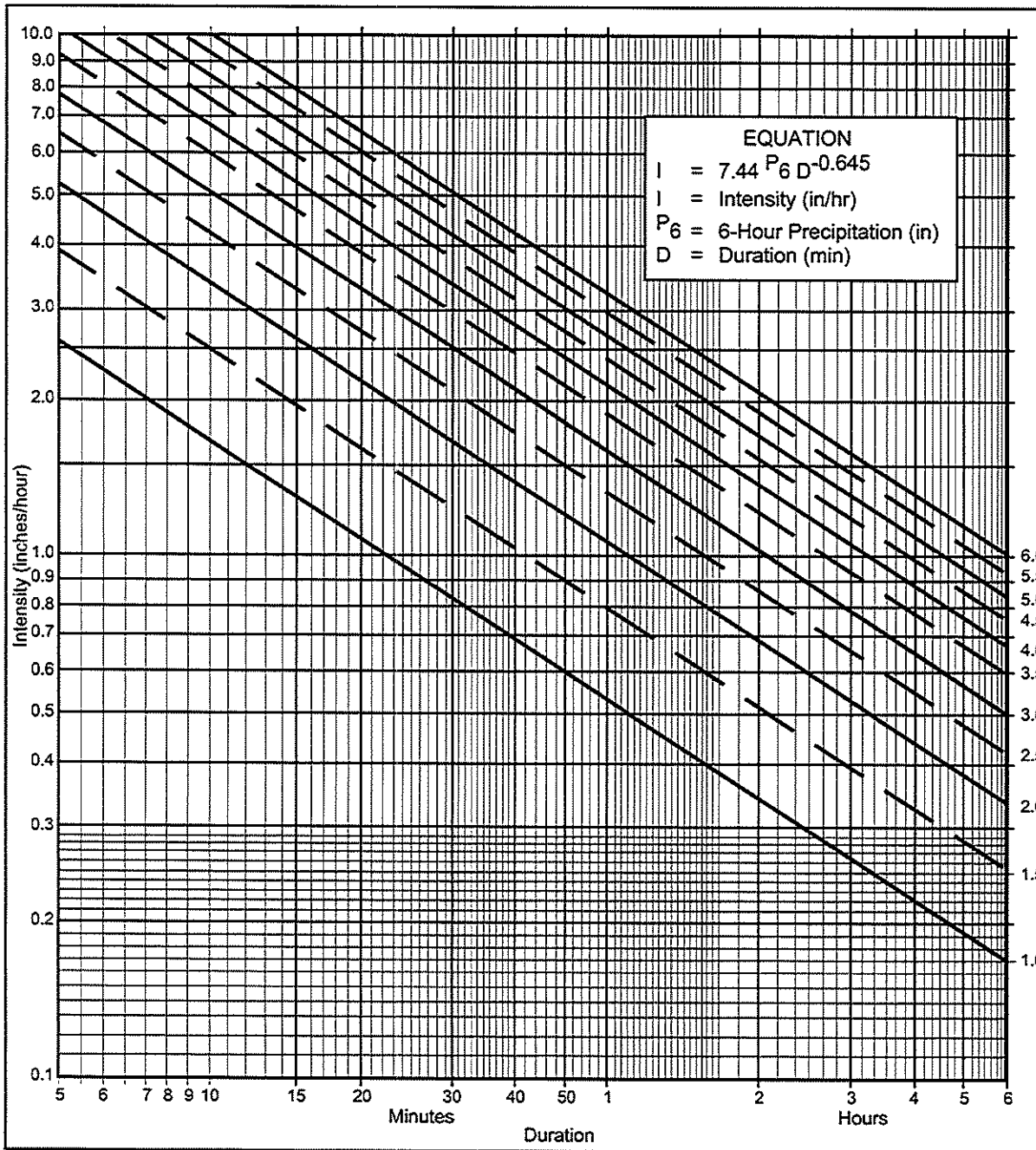

**Directions for Application:**

- (1) From precipitation maps determine 6 hr and 24 hr amounts for the selected frequency. These maps are included in the County Hydrology Manual (10, 50, and 100 yr maps included in the Design and Procedure Manual).
- (2) Adjust 6 hr precipitation (if necessary) so that it is within the range of 45% to 65% of the 24 hr precipitation (not applicable to Desert).
- (3) Plot 6 hr precipitation on the right side of the chart.
- (4) Draw a line through the point parallel to the plotted lines.
- (5) This line is the intensity-duration curve for the location being analyzed.

**Application Form:**

- (a) Selected frequency 100 year
- (b)  $P_6 = \frac{2.4}{\text{in.}}$ ,  $P_{24} = \frac{4.0}{\text{in.}}$ ,  $\frac{P_6}{P_{24}} = \frac{60}{\%^{(2)}}$
- (c) Adjusted  $P_6^{(2)} = \text{_____ in.}$
- (d)  $t_x = \text{_____ min.}$
- (e)  $I = \text{_____ in./hr.}$

Note: This chart replaces the Intensity-Duration-Frequency curves used since 1965.

P6	1	1.5	2	2.5	3	3.5	4	4.5	5	5.5	6
Duration											
5	2.63	3.95	5.27	6.59	7.90	9.22	10.54	11.86	13.17	14.49	15.81
7	2.12	3.18	4.24	5.30	6.36	7.42	8.48	9.54	10.60	11.66	12.72
10	1.68	2.53	3.37	4.21	5.05	5.90	6.74	7.58	8.42	9.27	10.11
15	1.30	1.95	2.59	3.24	3.89	4.54	5.19	5.84	6.49	7.13	7.78
20	1.08	1.62	2.15	2.69	3.23	3.77	4.31	4.85	5.39	5.93	6.46
25	0.93	1.40	1.87	2.33	2.80	3.27	3.73	4.20	4.67	5.13	5.60
30	0.83	1.24	1.66	2.07	2.49	2.90	3.32	3.73	4.15	4.56	4.98
40	0.69	1.03	1.38	1.72	2.07	2.41	2.76	3.10	3.45	3.79	4.13
50	0.60	0.90	1.19	1.49	1.79	2.09	2.39	2.69	2.98	3.28	3.58
60	0.53	0.80	1.06	1.33	1.59	1.86	2.12	2.39	2.65	2.92	3.18
90	0.41	0.61	0.82	1.02	1.23	1.43	1.63	1.84	2.04	2.25	2.45
120	0.34	0.51	0.68	0.85	1.02	1.19	1.36	1.53	1.70	1.87	2.04
150	0.29	0.44	0.59	0.73	0.88	1.03	1.18	1.32	1.47	1.62	1.76
180	0.26	0.39	0.52	0.65	0.78	0.91	1.04	1.18	1.31	1.44	1.57
240	0.22	0.33	0.43	0.54	0.65	0.76	0.87	0.98	1.08	1.19	1.30
300	0.19	0.28	0.38	0.47	0.56	0.66	0.75	0.85	0.94	1.03	1.13
360	0.17	0.25	0.33	0.42	0.50	0.58	0.67	0.75	0.84	0.92	1.00

**Intensity-Duration Design Chart - Template**



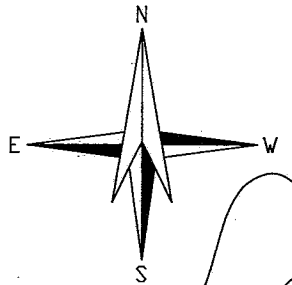

SCALE: 1" = 10,000'

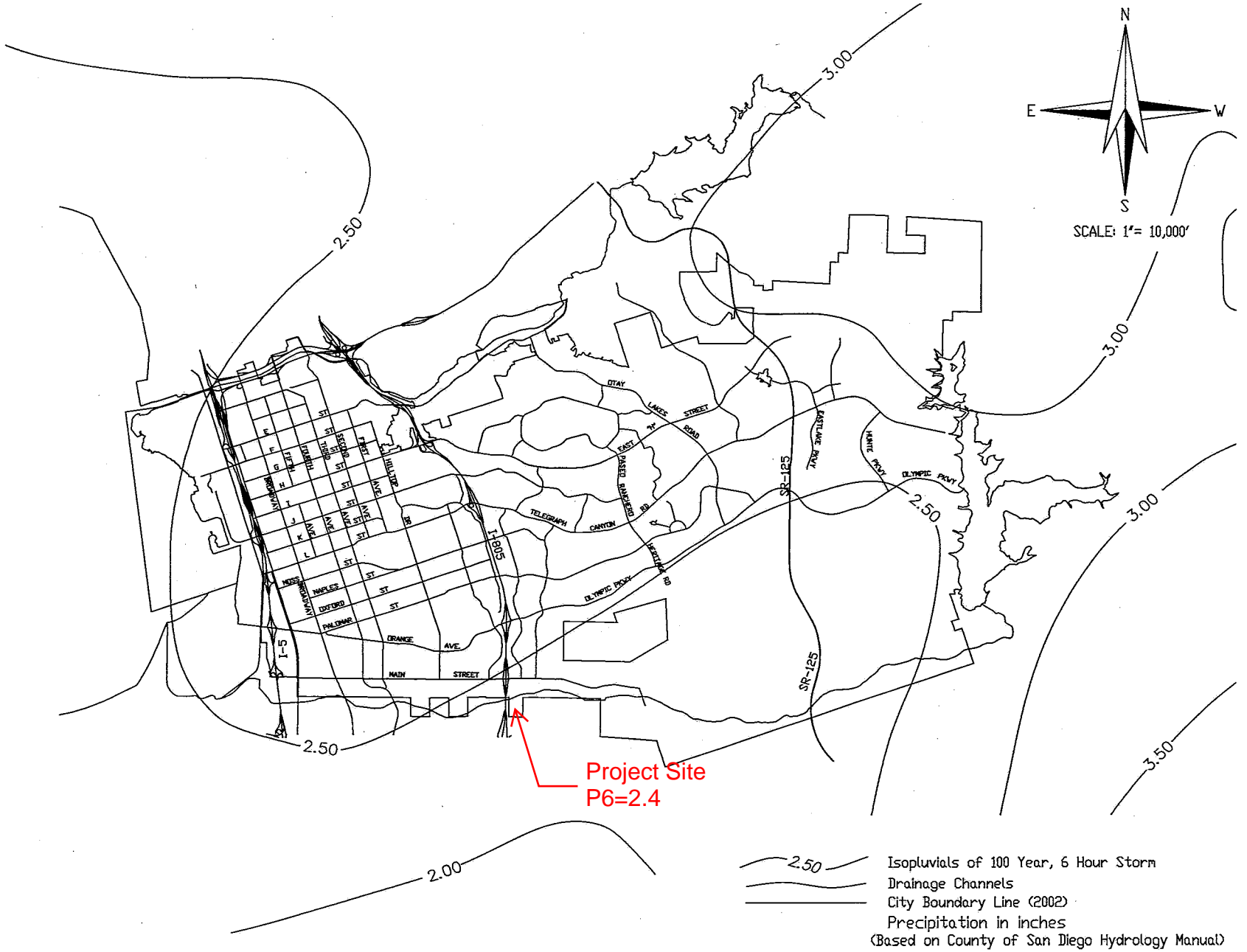

— 2.50 — Isopluivals of 100 Year, 6 Hour Storm  
 ——— Drainage Channels  
 ——— City Boundary Line (2002)  
 ——— Precipitation in inches  
 (Based on County of San Diego Hydrology Manual)

REVISION	BY	APPROVED	DATE
ORIGINAL			01/02
REVISION	CWM	C. SWANSON	11/02
REVISION	DPH	W. VALLÉ	11/17
CITY OF CHULA VISTA ENGINEERING & CAPITAL PROJECTS STANDARD DRAWING			
100-YEAR, 6-HOUR PRECIPITATION			
WILLIAM S. VALLÉ CITY ENGINEER			11/21/2017
DRN-04			

# County of San Diego Hydrology Manual



## Rainfall Isopluvials

### 100 Year Rainfall Event - 24 Hours

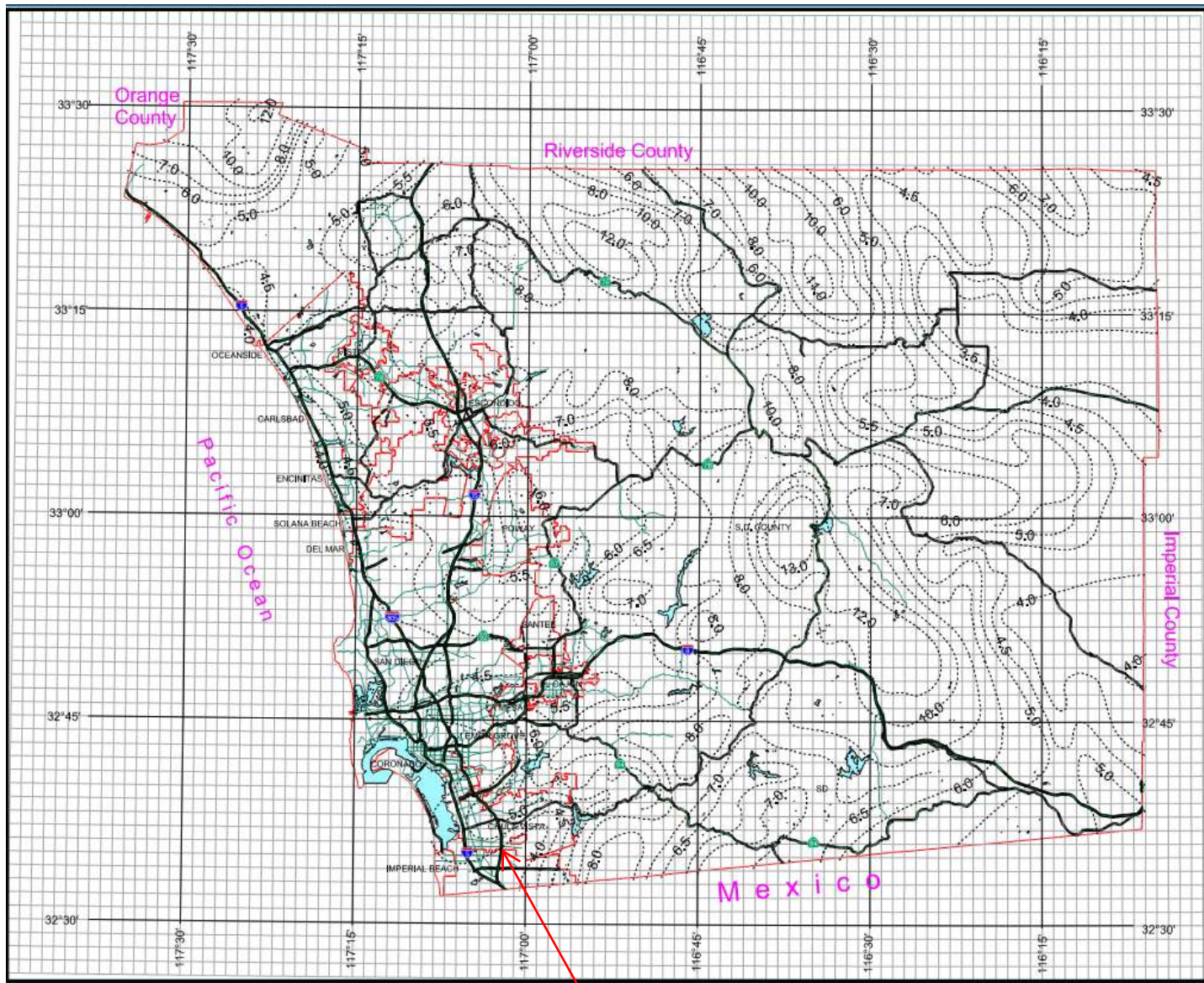

**DPW GIS**  
Department of Public Works  
Geographic Information Systems

**SanGIS**  
We Have San Diego Covered!

THE MAP IS PROVIDED WITHOUT WARRANTY OF ANY KIND, EITHER EXPRESS OR IMPLIED, INCLUDING, BUT NOT LIMITED TO, THE IMPLIED WARRANTIES OF MERCHANTABILITY AND FITNESS FOR A PARTICULAR PURPOSE. Copyright San Diego GIS. All Rights Reserved.

The products may contain information that is the SDAGIS Registered Information System which cannot be reproduced without the written consent of SDAGIS.

The product may contain information which has been reproduced with permission granted by Thomas Brothers Maps.

Project Site

### 3-203 Hydrology

Developers draining to a river or stream will be required to use the latest adopted County Hydrology Manual to determine the flows expected at a given frequency (Q10, Q50, Q100, etc.) Infill developments will use the following Hydrology requirements. The City Engineer will determine which projects may be considered "infill" projects.

#### 3-203.1 Previously Approved Reports

Runoff quantities; as set forth or derived from the report prepared by Lawrence, Fogg, Florer and Smith titled "A Special Study of Storm Drain Facilities" on file in the office of the City Engineer may be used in the design of drainage facilities in Chula Vista. A hydrologic study prepared and approved at General Development Plan (GDP) or Specific Planning Area (SPA) plan may be used as determined by the City Engineer.

#### 3-203.2

**For local drainage basins**, storm discharge flow may be estimated based on the Rational Method or the Modified Rational Method. For all lateral and major drainage basins the SCS method, U.S. Army Corps of Engineers HEC-1 computer method or other tabular or computer method may be used upon City Engineer approval.

#### 3-203.3 Rational and Modified Rational Methods

- (1) The rational method equation relates storm rainfall intensity (I), a selected runoff coefficient (C) and drainage area (A) to the peak runoff rate (Q):

$$Q = CIA \text{ (Empirical Units)}$$

where:

Q = Peak runoff in cubic feet per second  
C = Runoff coefficient  
I = Intensity, inches per hours  
A = Drainage basin area in acres

Or

$$Q=0.278CIA \text{ (Metric Units)}$$

where:

Q = Peak runoff in cubic meters per second  
C = Runoff coefficient  
I = Intensity in millimeters per second  
A = Drainage area in square kilometers

- (2) Coefficient of Runoff: Consider probable development. Use highest number of the following values:

a)	Paved Surface	0.90
b)	Commercial Area	0.85
c)	Dense Residential (R2, R3)	0.75

d)	Normal Residential (R1)	0.65
e)	Suburban Property (RE)	0.55
f)	Barren Slopes Steep	0.80
g)	Barren Slopes Hilly	0.75
h)	" " Rolling	0.70
i)	" " Flat	0.65
j)	Vegetated Slopes Steep	0.60
k)	" " Hilly	0.55
l)	" " Rolling	0.50
m)	" " Flat	0.45
n)	Farm Land	0.35
o)	Parks, Golf Courses	0.30

NOTES: Steep = Steep, rugged terrain with average slopes generally above 30%.  
 Hilly = Hilly terrain with average slopes of 10% to 30%.  
 Rolling = Rolling terrain with average slopes of 5% to 10%.  
 Flat = Relatively flat land, with average slopes of 0% to 5%.  
 Composite = Where drainage areas are composed of parts having different runoff characteristics, a weighted coefficient for the total drainage area may be used.

The runoff coefficient for a basin should be a composite coefficient made of the many different runoff coefficients for the sub-areas of the basin per equation:

$$CA_T = \frac{C_1A_1 + C_2A_2 + \dots + C_nA_n}{n}$$

(3) Time of Concentration ( $t_c$  = minutes) is the time required for runoff to flow from the most remote part of the watershed to the outlet point under consideration. With exceptions for limited natural watersheds, the time of concentration shall be calculated as follows:

a)  $t_c = t_i + t_r$                       where:

$t_i$  = Initial time or overland flow time of concentration, the time required for runoff to flow to the first inlet or to the street gutter

$t_r$  = Travel time of concentration, the time required for runoff to flow within street gutters to inlets, with channels or within storm drain pipes.

b)  $t_i$  may be calculated using the following natural watershed flow formula:

$$t_i = 60x [(11.9L^3)/H]^{0.385}$$

L = Length of water shed (miles)

H = Difference in elevation from furthestmost point to the design point (feet).

Hydrologic Soil Group—San Diego County Area, California

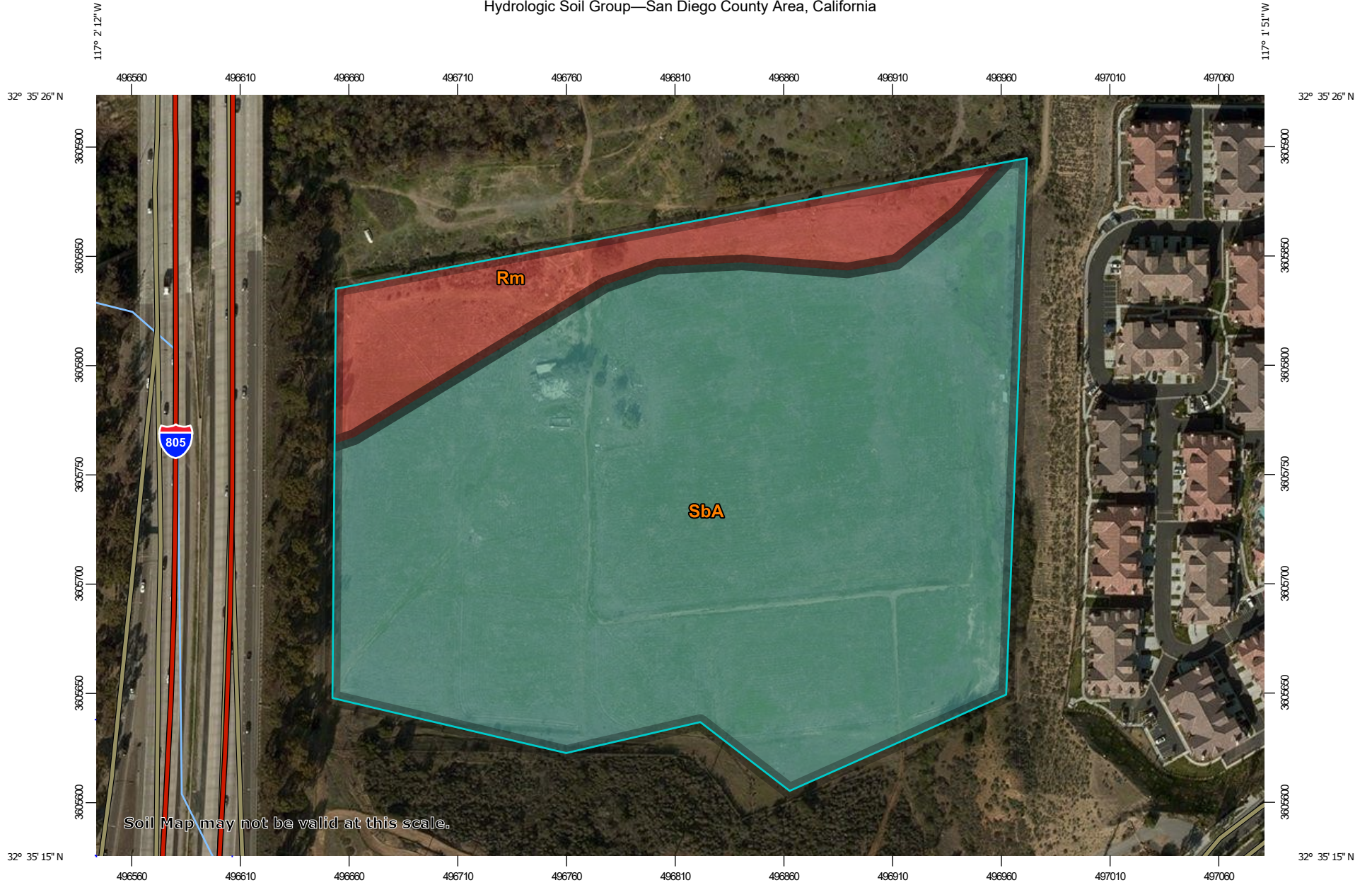

Soil Map may not be valid at this scale.

Map Scale: 1:2,460 if printed on A landscape (11" x 8.5") sheet.

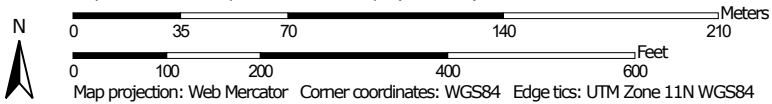

## MAP LEGEND

### Area of Interest (AOI)









 Area of Interest (AOI)

### Soils

#### Soil Rating Polygons





 A  
 A/D  
 B  
 B/D  
 C  
 C/D  
 D  
 Not rated or not available

#### Soil Rating Lines

 A  
 A/D  
 B  
 B/D  
 C  
 C/D  
 D  
 Not rated or not available

#### Soil Rating Points





 A  
 A/D  
 B  
 B/D

 C  
 C/D  
 D  
 Not rated or not available

### Water Features

 Streams and Canals

### Transportation

 Rails  
 Interstate Highways  
 US Routes  
 Major Roads  
 Local Roads

### Background

 Aerial Photography

## MAP INFORMATION

The soil surveys that comprise your AOI were mapped at 1:24,000.

**Warning:** Soil Map may not be valid at this scale.

Enlargement of maps beyond the scale of mapping can cause misunderstanding of the detail of mapping and accuracy of soil line placement. The maps do not show the small areas of contrasting soils that could have been shown at a more detailed scale.

Please rely on the bar scale on each map sheet for map measurements.

Source of Map: Natural Resources Conservation Service  
 Web Soil Survey URL:  
 Coordinate System: Web Mercator (EPSG:3857)

Maps from the Web Soil Survey are based on the Web Mercator projection, which preserves direction and shape but distorts distance and area. A projection that preserves area, such as the Albers equal-area conic projection, should be used if more accurate calculations of distance or area are required.

This product is generated from the USDA-NRCS certified data as of the version date(s) listed below.

Soil Survey Area: San Diego County Area, California  
 Survey Area Data: Version 14, Sep 16, 2019

Soil map units are labeled (as space allows) for map scales 1:50,000 or larger.

Date(s) aerial images were photographed: Dec 7, 2014—Jan 4, 2015

The orthophoto or other base map on which the soil lines were compiled and digitized probably differs from the background imagery displayed on these maps. As a result, some minor shifting of map unit boundaries may be evident.

## Hydrologic Soil Group

Map unit symbol	Map unit name	Rating	Acres in AOI	Percent of AOI
Rm	Riverwash	D	2.6	14.1%
SbA	Salinas clay loam, 0 to 2 percent slopes, warm MAAT, MLRA 19	C	15.7	85.9%
<b>Totals for Area of Interest</b>			<b>18.3</b>	<b>100.0%</b>

### Description

Hydrologic soil groups are based on estimates of runoff potential. Soils are assigned to one of four groups according to the rate of water infiltration when the soils are not protected by vegetation, are thoroughly wet, and receive precipitation from long-duration storms.

The soils in the United States are assigned to four groups (A, B, C, and D) and three dual classes (A/D, B/D, and C/D). The groups are defined as follows:

Group A. Soils having a high infiltration rate (low runoff potential) when thoroughly wet. These consist mainly of deep, well drained to excessively drained sands or gravelly sands. These soils have a high rate of water transmission.

Group B. Soils having a moderate infiltration rate when thoroughly wet. These consist chiefly of moderately deep or deep, moderately well drained or well drained soils that have moderately fine texture to moderately coarse texture. These soils have a moderate rate of water transmission.

Group C. Soils having a slow infiltration rate when thoroughly wet. These consist chiefly of soils having a layer that impedes the downward movement of water or soils of moderately fine texture or fine texture. These soils have a slow rate of water transmission.

Group D. Soils having a very slow infiltration rate (high runoff potential) when thoroughly wet. These consist chiefly of clays that have a high shrink-swell potential, soils that have a high water table, soils that have a claypan or clay layer at or near the surface, and soils that are shallow over nearly impervious material. These soils have a very slow rate of water transmission.

If a soil is assigned to a dual hydrologic group (A/D, B/D, or C/D), the first letter is for drained areas and the second is for undrained areas. Only the soils that in their natural condition are in group D are assigned to dual classes.

### Rating Options

*Aggregation Method:* Dominant Condition

*Component Percent Cutoff: None Specified*

*Tie-break Rule: Higher*



## **APPENDIX 2**

### **Existing Conditions Rational Method Computer Output**

S100E100.RES

S100E100.RES

\*\*\*\*\*

RATIONAL METHOD HYDROLOGY COMPUTER PROGRAM PACKAGE
Reference: SAN DIEGO COUNTY FLOOD CONTROL DISTRICT
2003,1985,1981 HYDROLOGY MANUAL
(c) Copyright 1982-2016 Advanced Engineering Software (aes)
Ver. 23.0 Release Date: 07/01/2016 License ID 1509

Analysis prepared by:

\*\*\*\*\* DESCRIPTION OF STUDY \*\*\*\*\*
\* NAKANO 4409 \*
\* SYSTEM 100 - EXISTING CONDITIONS \*
\* 100 YEAR STORM EVENT \*
\*\*\*\*\*

FILE NAME: S100E100.DAT
TIME/DATE OF STUDY: 11:37 06/14/2022

USER SPECIFIED HYDROLOGY AND HYDRAULIC MODEL INFORMATION:

2003 SAN DIEGO MANUAL CRITERIA

USER SPECIFIED STORM EVENT(YEAR) = 100.00
6-HOUR DURATION PRECIPITATION (INCHES) = 2.400
SPECIFIED MINIMUM PIPE SIZE(INCH) = 18.00
SPECIFIED PERCENT OF GRADIENTS(DECIMAL) TO USE FOR FRICTION SLOPE = 0.95
SAN DIEGO HYDROLOGY MANUAL "C"-VALUES USED FOR RATIONAL METHOD
\*CITY OF CHULA VISTA TIME-OF-CONCENTRATION MODEL SELECTED.\*
(BASED ON 07/2002 ADOPTED MANUAL)

NOTE: USE MODIFIED RATIONAL METHOD PROCEDURES FOR CONFLUENCE ANALYSIS

\*USER-DEFINED STREET-SECTIONS FOR COUPLED PIPEFLOW AND STREETFLOW MODEL\*

Table with columns: NO., WIDTH (FT), CROSSFALL (FT), IN- / SIDE, OUT- / SIDE/ WAY, HEIGHT (FT), CURB / GUTTER, GUTTER-GEOMETRIES (FT), MANNING FACTOR (n)

GLOBAL STREET FLOW-DEPTH CONSTRAINTS:

- 1. Relative Flow-Depth = 0.00 FEET as (Maximum Allowable Street Flow Depth) - (Top-of-Curb)
2. (Depth)\*(Velocity) Constraint = 6.0 (FT\*FT/S)
\*SIZE PIPE WITH A FLOW CAPACITY GREATER THAN OR EQUAL TO THE UPSTREAM TRIBUTARY PIPE.\*

\*\*\*\*\* FLOW PROCESS FROM NODE 100.00 TO NODE 105.00 IS CODE = 22 \*\*\*\*\*

>>>>RATIONAL METHOD INITIAL SUBAREA ANALYSIS<<<<

\*USER SPECIFIED(SUBAREA):
USER-SPECIFIED RUNOFF COEFFICIENT = .6000
USER SPECIFIED Tc(MIN.) = 5.000
100 YEAR RAINFALL INTENSITY(INCH/HOUR) = 6.323
SUBAREA RUNOFF(CFS) = 1.06
TOTAL AREA(ACRES) = 0.28 TOTAL RUNOFF(CFS) = 1.06

\*\*\*\*\*

FLOW PROCESS FROM NODE 105.00 TO NODE 110.00 IS CODE = 51

>>>>COMPUTE TRAPEZOIDAL CHANNEL FLOW<<<<
>>>>TRAVELTIME THRU SUBAREA (EXISTING ELEMENT)<<<<

ELEVATION DATA: UPSTREAM(FEET) = 240.00 DOWNSTREAM(FEET) = 151.00
CHANNEL LENGTH THRU SUBAREA(FEET) = 825.00 CHANNEL SLOPE = 0.1079
CHANNEL BASE(FEET) = 10.00 "Z" FACTOR = 2.000
MANNING'S FACTOR = 0.030 MAXIMUM DEPTH(FEET) = 2.00
100 YEAR RAINFALL INTENSITY(INCH/HOUR) = 4.643
\*USER SPECIFIED(SUBAREA):
USER-SPECIFIED RUNOFF COEFFICIENT = .6000
TRAVEL TIME COMPUTED USING ESTIMATED FLOW(CFS) = 7.17
TRAVEL TIME THRU SUBAREA BASED ON VELOCITY(FEET/SEC.) = 4.48
AVERAGE FLOW DEPTH(FEET) = 0.16 TRAVEL TIME(MIN.) = 3.07
Tc(MIN.) = 8.07
SUBAREA AREA(ACRES) = 4.28 SUBAREA RUNOFF(CFS) = 11.92
AREA-AVERAGE RUNOFF COEFFICIENT = 0.600
TOTAL AREA(ACRES) = 4.6 PEAK FLOW RATE(CFS) = 12.70

END OF SUBAREA CHANNEL FLOW HYDRAULICS:
DEPTH(FEET) = 0.22 FLOW VELOCITY(FEET/SEC.) = 5.62
LONGEST FLOWPATH FROM NODE 100.00 TO NODE 110.00 = 825.00 FEET.

\*\*\*\*\*

FLOW PROCESS FROM NODE 110.00 TO NODE 110.00 IS CODE = 1

>>>>DESIGNATE INDEPENDENT STREAM FOR CONFLUENCE<<<<

TOTAL NUMBER OF STREAMS = 2
CONFLUENCE VALUES USED FOR INDEPENDENT STREAM 1 ARE:
TIME OF CONCENTRATION(MIN.) = 8.07
RAINFALL INTENSITY(INCH/HR) = 4.64
TOTAL STREAM AREA(ACRES) = 4.56
PEAK FLOW RATE(CFS) AT CONFLUENCE = 12.70

\*\*\*\*\*

FLOW PROCESS FROM NODE 109.00 TO NODE 110.00 IS CODE = 7

>>>>USER SPECIFIED HYDROLOGY INFORMATION AT NODE<<<<

USER-SPECIFIED VALUES ARE AS FOLLOWS:
TC(MIN) = 5.00 RAIN INTENSITY(INCH/HOUR) = 6.32
TOTAL AREA(ACRES) = 5.50 TOTAL RUNOFF(CFS) = 22.20

\*\*\*\*\*

FLOW PROCESS FROM NODE 110.00 TO NODE 110.00 IS CODE = 1

>>>>DESIGNATE INDEPENDENT STREAM FOR CONFLUENCE<<<<
>>>>AND COMPUTE VARIOUS CONFLUENCED STREAM VALUES<<<<

TOTAL NUMBER OF STREAMS = 2
CONFLUENCE VALUES USED FOR INDEPENDENT STREAM 2 ARE:
TIME OF CONCENTRATION(MIN.) = 5.00
RAINFALL INTENSITY(INCH/HR) = 6.32
TOTAL STREAM AREA(ACRES) = 5.50
PEAK FLOW RATE(CFS) AT CONFLUENCE = 22.20

\*\* CONFLUENCE DATA \*\*

Table with columns: STREAM NUMBER, RUNOFF (CFS), Tc (MIN.), INTENSITY (INCH/HOUR), AREA (ACRE)

S100E100.RES

2 22.20 5.00 6.323 5.50

RAINFALL INTENSITY AND TIME OF CONCENTRATION RATIO  
CONFLUENCE FORMULA USED FOR 2 STREAMS.

\*\* PEAK FLOW RATE TABLE \*\*

STREAM NUMBER	RUNOFF (CFS)	Tc (MIN.)	INTENSITY (INCH/HOUR)
1	30.07	5.00	6.323
2	29.00	8.07	4.643

COMPUTED CONFLUENCE ESTIMATES ARE AS FOLLOWS:

PEAK FLOW RATE(CFS) = 30.07 Tc(MIN.) = 5.00  
TOTAL AREA(ACRES) = 10.1  
LONGEST FLOWPATH FROM NODE 100.00 TO NODE 110.00 = 825.00 FEET.

\*\*\*\*\*  
FLOW PROCESS FROM NODE 110.00 TO NODE 115.00 IS CODE = 51

>>>>COMPUTE TRAPEZOIDAL CHANNEL FLOW<<<<<<  
>>>>TRAVELTIME THRU SUBAREA (EXISTING ELEMENT)<<<<<<

ELEVATION DATA: UPSTREAM(FEET) = 151.00 DOWNSTREAM(FEET) = 132.00  
CHANNEL LENGTH THRU SUBAREA(FEET) = 304.00 CHANNEL SLOPE = 0.0625  
CHANNEL BASE(FEET) = 5.00 "Z" FACTOR = 2.500  
MANNING'S FACTOR = 0.045 MAXIMUM DEPTH(FEET) = 2.00  
100 YEAR RAINFALL INTENSITY(INCH/HOUR) = 5.726  
\*USER SPECIFIED(SUBAREA):  
USER-SPECIFIED RUNOFF COEFFICIENT = .8000  
TRAVEL TIME COMPUTED USING ESTIMATED FLOW(CFS) = 37.29  
TRAVEL TIME THRU SUBAREA BASED ON VELOCITY(FEET/SEC.) = 6.09  
AVERAGE FLOW DEPTH(FEET) = 0.86 TRAVEL TIME(MIN.) = 0.83  
Tc(MIN.) = 5.83  
SUBAREA AREA(ACRES) = 3.16 SUBAREA RUNOFF(CFS) = 14.47  
AREA-AVERAGE RUNOFF COEFFICIENT = 0.664  
TOTAL AREA(ACRES) = 13.2 PEAK FLOW RATE(CFS) = 50.24

END OF SUBAREA CHANNEL FLOW HYDRAULICS:  
DEPTH(FEET) = 1.00 FLOW VELOCITY(FEET/SEC.) = 6.66  
LONGEST FLOWPATH FROM NODE 100.00 TO NODE 115.00 = 1129.00 FEET.

\*\*\*\*\*  
FLOW PROCESS FROM NODE 115.00 TO NODE 120.00 IS CODE = 51

>>>>COMPUTE TRAPEZOIDAL CHANNEL FLOW<<<<<<  
>>>>TRAVELTIME THRU SUBAREA (EXISTING ELEMENT)<<<<<<

ELEVATION DATA: UPSTREAM(FEET) = 132.00 DOWNSTREAM(FEET) = 105.00  
CHANNEL LENGTH THRU SUBAREA(FEET) = 896.00 CHANNEL SLOPE = 0.0301  
CHANNEL BASE(FEET) = 5.00 "Z" FACTOR = 50.000  
MANNING'S FACTOR = 0.030 MAXIMUM DEPTH(FEET) = 2.00  
100 YEAR RAINFALL INTENSITY(INCH/HOUR) = 4.049  
\*USER SPECIFIED(SUBAREA):  
USER-SPECIFIED RUNOFF COEFFICIENT = .4500  
TRAVEL TIME COMPUTED USING ESTIMATED FLOW(CFS) = 52.62  
TRAVEL TIME THRU SUBAREA BASED ON VELOCITY(FEET/SEC.) = 3.60  
AVERAGE FLOW DEPTH(FEET) = 0.49 TRAVEL TIME(MIN.) = 4.15  
Tc(MIN.) = 9.98  
SUBAREA AREA(ACRES) = 2.61 SUBAREA RUNOFF(CFS) = 4.76  
AREA-AVERAGE RUNOFF COEFFICIENT = 0.629  
TOTAL AREA(ACRES) = 15.8 PEAK FLOW RATE(CFS) = 50.24

END OF SUBAREA CHANNEL FLOW HYDRAULICS:

S100E100.RES

DEPTH(FEET) = 0.49 FLOW VELOCITY(FEET/SEC.) = 3.54  
LONGEST FLOWPATH FROM NODE 100.00 TO NODE 120.00 = 2025.00 FEET.

=====  
END OF STUDY SUMMARY:  
TOTAL AREA(ACRES) = 15.8 TC(MIN.) = 9.98  
PEAK FLOW RATE(CFS) = 50.24  
=====

END OF RATIONAL METHOD ANALYSIS

□

S130E100.RES

\*\*\*\*\*

RATIONAL METHOD HYDROLOGY COMPUTER PROGRAM PACKAGE
Reference: SAN DIEGO COUNTY FLOOD CONTROL DISTRICT
2003,1985,1981 HYDROLOGY MANUAL
(c) Copyright 1982-2016 Advanced Engineering Software (aes)
Ver. 23.0 Release Date: 07/01/2016 License ID 1509

Analysis prepared by:

\*\*\*\*\* DESCRIPTION OF STUDY \*\*\*\*\*
\* NAKANO 4409 \*
\* SYSTEM 130 - EXISTING CONDITIONS \*
\* 100 YEAR STORM EVENT \*

FILE NAME: S130E100.DAT
TIME/DATE OF STUDY: 11:38 06/14/2022

USER SPECIFIED HYDROLOGY AND HYDRAULIC MODEL INFORMATION:

2003 SAN DIEGO MANUAL CRITERIA

USER SPECIFIED STORM EVENT(YEAR) = 100.00
6-HOUR DURATION PRECIPITATION (INCHES) = 2.400
SPECIFIED MINIMUM PIPE SIZE(INCH) = 18.00
SPECIFIED PERCENT OF GRADIENTS(DECIMAL) TO USE FOR FRICTION SLOPE = 0.95
SAN DIEGO HYDROLOGY MANUAL "C"-VALUES USED FOR RATIONAL METHOD
\*CITY OF CHULA VISTA TIME-OF-CONCENTRATION MODEL SELECTED.\*
(BASED ON 07/2002 ADOPTED MANUAL)

NOTE: USE MODIFIED RATIONAL METHOD PROCEDURES FOR CONFLUENCE ANALYSIS

\*USER-DEFINED STREET-SECTIONS FOR COUPLED PIPEFLOW AND STREETFLOW MODEL\*

Table with 10 columns: NO., WIDTH (FT), CROSSFALL (FT), IN- / SIDE, OUT- / SIDE/ WAY, HEIGHT (FT), CURB, GUTTER, LIP, HIKE, MANNING FACTOR. Row 1: 1, 30.0, 20.0, 0.018/0.018, 0.020, 0.67, 2.00, 0.0313, 0.167, 0.0150

GLOBAL STREET FLOW-DEPTH CONSTRAINTS:

- 1. Relative Flow-Depth = 0.00 FEET as (Maximum Allowable Street Flow Depth) - (Top-of-Curb)
2. (Depth)\*(Velocity) Constraint = 6.0 (FT\*FT/S)
\*SIZE PIPE WITH A FLOW CAPACITY GREATER THAN OR EQUAL TO THE UPSTREAM TRIBUTARY PIPE.\*

\*\*\*\*\* FLOW PROCESS FROM NODE 130.00 TO NODE 135.00 IS CODE = 22 \*\*\*\*\*

>>>>RATIONAL METHOD INITIAL SUBAREA ANALYSIS<<<<

\*USER SPECIFIED(SUBAREA):
USER-SPECIFIED RUNOFF COEFFICIENT = .5500
USER SPECIFIED Tc(MIN.) = 5.000
100 YEAR RAINFALL INTENSITY(INCH/HOUR) = 6.323
SUBAREA RUNOFF(CFS) = 0.90
TOTAL AREA(ACRES) = 0.26 TOTAL RUNOFF(CFS) = 0.90

S130E100.RES

\*\*\*\*\* FLOW PROCESS FROM NODE 135.00 TO NODE 140.00 IS CODE = 51 \*\*\*\*\*

>>>>COMPUTE TRAPEZOIDAL CHANNEL FLOW<<<<
>>>>TRAVELTIME THRU SUBAREA (EXISTING ELEMENT)<<<<

ELEVATION DATA: UPSTREAM(FEET) = 202.00 DOWNSTREAM(FEET) = 122.00
CHANNEL LENGTH THRU SUBAREA(FEET) = 354.88 CHANNEL SLOPE = 0.2254
CHANNEL BASE(FEET) = 10.00 "Z" FACTOR = 50.000
MANNING'S FACTOR = 0.045 MAXIMUM DEPTH(FEET) = 2.00
100 YEAR RAINFALL INTENSITY(INCH/HOUR) = 5.198
\*USER SPECIFIED(SUBAREA):
USER-SPECIFIED RUNOFF COEFFICIENT = .6000
TRAVEL TIME COMPUTED USING ESTIMATED FLOW(CFS) = 7.94
TRAVEL TIME THRU SUBAREA BASED ON VELOCITY(FEET/SEC.) = 3.33
AVERAGE FLOW DEPTH(FEET) = 0.14 TRAVEL TIME(MIN.) = 1.78
Tc(MIN.) = 6.78
SUBAREA AREA(ACRES) = 4.50 SUBAREA RUNOFF(CFS) = 14.03
AREA-AVERAGE RUNOFF COEFFICIENT = 0.597
TOTAL AREA(ACRES) = 4.8 PEAK FLOW RATE(CFS) = 14.78

END OF SUBAREA CHANNEL FLOW HYDRAULICS:
DEPTH(FEET) = 0.19 FLOW VELOCITY(FEET/SEC.) = 4.06
LONGEST FLOWPATH FROM NODE 130.00 TO NODE 140.00 = 1250.88 FEET.

\*\*\*\*\* FLOW PROCESS FROM NODE 140.00 TO NODE 142.00 IS CODE = 51 \*\*\*\*\*

>>>>COMPUTE TRAPEZOIDAL CHANNEL FLOW<<<<
>>>>TRAVELTIME THRU SUBAREA (EXISTING ELEMENT)<<<<

ELEVATION DATA: UPSTREAM(FEET) = 122.00 DOWNSTREAM(FEET) = 103.00
CHANNEL LENGTH THRU SUBAREA(FEET) = 675.00 CHANNEL SLOPE = 0.0281
CHANNEL BASE(FEET) = 5.00 "Z" FACTOR = 50.000
MANNING'S FACTOR = 0.030 MAXIMUM DEPTH(FEET) = 2.00
100 YEAR RAINFALL INTENSITY(INCH/HOUR) = 3.827
\*USER SPECIFIED(SUBAREA):
USER-SPECIFIED RUNOFF COEFFICIENT = .4500
TRAVEL TIME COMPUTED USING ESTIMATED FLOW(CFS) = 19.48
TRAVEL TIME THRU SUBAREA BASED ON VELOCITY(FEET/SEC.) = 2.73
AVERAGE FLOW DEPTH(FEET) = 0.33 TRAVEL TIME(MIN.) = 4.12
Tc(MIN.) = 10.89
SUBAREA AREA(ACRES) = 5.40 SUBAREA RUNOFF(CFS) = 9.30
AREA-AVERAGE RUNOFF COEFFICIENT = 0.519
TOTAL AREA(ACRES) = 10.2 PEAK FLOW RATE(CFS) = 20.18

END OF SUBAREA CHANNEL FLOW HYDRAULICS:
DEPTH(FEET) = 0.34 FLOW VELOCITY(FEET/SEC.) = 2.72
LONGEST FLOWPATH FROM NODE 130.00 TO NODE 142.00 = 1925.88 FEET.

\*\*\*\*\* FLOW PROCESS FROM NODE 142.00 TO NODE 145.00 IS CODE = 51 \*\*\*\*\*

>>>>COMPUTE TRAPEZOIDAL CHANNEL FLOW<<<<
>>>>TRAVELTIME THRU SUBAREA (EXISTING ELEMENT)<<<<

ELEVATION DATA: UPSTREAM(FEET) = 103.00 DOWNSTREAM(FEET) = 98.00
CHANNEL LENGTH THRU SUBAREA(FEET) = 242.00 CHANNEL SLOPE = 0.0207
CHANNEL BASE(FEET) = 10.00 "Z" FACTOR = 4.000
MANNING'S FACTOR = 0.030 MAXIMUM DEPTH(FEET) = 1.00
100 YEAR RAINFALL INTENSITY(INCH/HOUR) = 3.623
\*USER SPECIFIED(SUBAREA):
USER-SPECIFIED RUNOFF COEFFICIENT = .4500

**S130E100.RES**

TRAVEL TIME COMPUTED USING ESTIMATED FLOW(CFS) = 27.34  
TRAVEL TIME THRU SUBAREA BASED ON VELOCITY(FEET/SEC.) = 4.19  
AVERAGE FLOW DEPTH(FEET) = 0.54 TRAVEL TIME(MIN.) = 0.96  
Tc(MIN.) = 11.86  
SUBAREA AREA(ACRES) = 8.78 SUBAREA RUNOFF(CFS) = 14.32  
AREA-AVERAGE RUNOFF COEFFICIENT = 0.487  
TOTAL AREA(ACRES) = 18.9 PEAK FLOW RATE(CFS) = 33.42

END OF SUBAREA CHANNEL FLOW HYDRAULICS:  
DEPTH(FEET) = 0.60 FLOW VELOCITY(FEET/SEC.) = 4.49  
LONGEST FLOWPATH FROM NODE 130.00 TO NODE 145.00 = 2167.88 FEET.

=====  
END OF STUDY SUMMARY:  
TOTAL AREA(ACRES) = 18.9 TC(MIN.) = 11.86  
PEAK FLOW RATE(CFS) = 33.42  
=====

=====  
END OF RATIONAL METHOD ANALYSIS  
=====

□

S160E100.RES

S160E100.RES

\*\*\*\*\*

RATIONAL METHOD HYDROLOGY COMPUTER PROGRAM PACKAGE
Reference: SAN DIEGO COUNTY FLOOD CONTROL DISTRICT
2003,1985,1981 HYDROLOGY MANUAL
(c) Copyright 1982-2016 Advanced Engineering Software (aes)
Ver. 23.0 Release Date: 07/01/2016 License ID 1509

Analysis prepared by:

\*\*\*\*\* DESCRIPTION OF STUDY \*\*\*\*\*
\* NAKANO 4409 \*
\* SYSTEM 160 - EXISTING CONDITIONS \*
\* 100 YEAR STORM EVENT \*
\*\*\*\*\*

FILE NAME: S160E100.DAT
TIME/DATE OF STUDY: 11:40 06/14/2022

USER SPECIFIED HYDROLOGY AND HYDRAULIC MODEL INFORMATION:

2003 SAN DIEGO MANUAL CRITERIA

USER SPECIFIED STORM EVENT(YEAR) = 100.00
6-HOUR DURATION PRECIPITATION (INCHES) = 2.400
SPECIFIED MINIMUM PIPE SIZE(INCH) = 18.00
SPECIFIED PERCENT OF GRADIENTS(DECIMAL) TO USE FOR FRICTION SLOPE = 0.95
SAN DIEGO HYDROLOGY MANUAL "C"-VALUES USED FOR RATIONAL METHOD
\*CITY OF CHULA VISTA TIME-OF-CONCENTRATION MODEL SELECTED.\*
(BASED ON 07/2002 ADOPTED MANUAL)

NOTE: USE MODIFIED RATIONAL METHOD PROCEDURES FOR CONFLUENCE ANALYSIS

\*USER-DEFINED STREET-SECTIONS FOR COUPLED PIPEFLOW AND STREETFLOW MODEL\*

Table with 10 columns: NO., WIDTH (FT), CROSSFALL (FT), IN- / SIDE, OUT- / SIDE/ WAY, HEIGHT (FT), CURB, GUTTER, LIP, HIKE, MANNING FACTOR. Row 1: 1, 30.0, 20.0, 0.018/0.018, 0.020, 0.67, 2.00, 0.0313, 0.167, 0.0150

GLOBAL STREET FLOW-DEPTH CONSTRAINTS:

- 1. Relative Flow-Depth = 0.00 FEET as (Maximum Allowable Street Flow Depth) - (Top-of-Curb)
2. (Depth)\*(Velocity) Constraint = 6.0 (FT\*FT/S)
\*SIZE PIPE WITH A FLOW CAPACITY GREATER THAN OR EQUAL TO THE UPSTREAM TRIBUTARY PIPE.\*

\*\*\*\*\*
FLOW PROCESS FROM NODE 160.00 TO NODE 165.00 IS CODE = 22
\*\*\*\*\*

>>>>RATIONAL METHOD INITIAL SUBAREA ANALYSIS<<<<

\*USER SPECIFIED(SUBAREA):
USER-SPECIFIED RUNOFF COEFFICIENT = .5500
USER SPECIFIED Tc(MIN.) = 5.000
100 YEAR RAINFALL INTENSITY(INCH/HOUR) = 6.323
SUBAREA RUNOFF(CFS) = 0.80
TOTAL AREA(ACRES) = 0.23 TOTAL RUNOFF(CFS) = 0.80

\*\*\*\*\*

FLOW PROCESS FROM NODE 165.00 TO NODE 170.00 IS CODE = 51

>>>>COMPUTE TRAPEZOIDAL CHANNEL FLOW<<<<
>>>>TRAVELTIME THRU SUBAREA (EXISTING ELEMENT)<<<<

ELEVATION DATA: UPSTREAM(FEET) = 166.00 DOWNSTREAM(FEET) = 118.00
CHANNEL LENGTH THRU SUBAREA(FEET) = 158.93 CHANNEL SLOPE = 0.3020
CHANNEL BASE(FEET) = 4.00 "Z" FACTOR = 10.000
MANNING'S FACTOR = 0.035 MAXIMUM DEPTH(FEET) = 2.00
100 YEAR RAINFALL INTENSITY(INCH/HOUR) = 5.857
\*USER SPECIFIED(SUBAREA):
USER-SPECIFIED RUNOFF COEFFICIENT = .6000
TRAVEL TIME COMPUTED USING ESTIMATED FLOW(CFS) = 1.82
TRAVEL TIME THRU SUBAREA BASED ON VELOCITY(FEET/SEC.) = 4.20
AVERAGE FLOW DEPTH(FEET) = 0.09 TRAVEL TIME(MIN.) = 0.63
Tc(MIN.) = 5.63
SUBAREA AREA(ACRES) = 0.58 SUBAREA RUNOFF(CFS) = 2.04
AREA-AVERAGE RUNOFF COEFFICIENT = 0.586
TOTAL AREA(ACRES) = 0.8 PEAK FLOW RATE(CFS) = 2.78

END OF SUBAREA CHANNEL FLOW HYDRAULICS:
DEPTH(FEET) = 0.11 FLOW VELOCITY(FEET/SEC.) = 4.87
LONGEST FLOWPATH FROM NODE 160.00 TO NODE 170.00 = 400.93 FEET.

\*\*\*\*\*

FLOW PROCESS FROM NODE 170.00 TO NODE 175.00 IS CODE = 51

>>>>COMPUTE TRAPEZOIDAL CHANNEL FLOW<<<<
>>>>TRAVELTIME THRU SUBAREA (EXISTING ELEMENT)<<<<

ELEVATION DATA: UPSTREAM(FEET) = 118.00 DOWNSTREAM(FEET) = 100.00
CHANNEL LENGTH THRU SUBAREA(FEET) = 681.00 CHANNEL SLOPE = 0.0264
CHANNEL BASE(FEET) = 4.00 "Z" FACTOR = 10.000
MANNING'S FACTOR = 0.035 MAXIMUM DEPTH(FEET) = 2.00
100 YEAR RAINFALL INTENSITY(INCH/HOUR) = 4.001
\*USER SPECIFIED(SUBAREA):
USER-SPECIFIED RUNOFF COEFFICIENT = .5500
TRAVEL TIME COMPUTED USING ESTIMATED FLOW(CFS) = 5.85
TRAVEL TIME THRU SUBAREA BASED ON VELOCITY(FEET/SEC.) = 2.50
AVERAGE FLOW DEPTH(FEET) = 0.32 TRAVEL TIME(MIN.) = 4.54
Tc(MIN.) = 10.17
SUBAREA AREA(ACRES) = 2.73 SUBAREA RUNOFF(CFS) = 6.01
AREA-AVERAGE RUNOFF COEFFICIENT = 0.558
TOTAL AREA(ACRES) = 3.5 PEAK FLOW RATE(CFS) = 7.91

END OF SUBAREA CHANNEL FLOW HYDRAULICS:
DEPTH(FEET) = 0.37 FLOW VELOCITY(FEET/SEC.) = 2.76
LONGEST FLOWPATH FROM NODE 160.00 TO NODE 175.00 = 1081.93 FEET.

END OF STUDY SUMMARY:
TOTAL AREA(ACRES) = 3.5 TC(MIN.) = 10.17
PEAK FLOW RATE(CFS) = 7.91

END OF RATIONAL METHOD ANALYSIS

□

## **APPENDIX 3**

### **Proposed Conditions Rational Method Computer Output**

1000P100.RES

\*\*\*\*\*

RATIONAL METHOD HYDROLOGY COMPUTER PROGRAM PACKAGE  
 Reference: SAN DIEGO COUNTY FLOOD CONTROL DISTRICT  
 2003,1985,1981 HYDROLOGY MANUAL  
 (c) Copyright 1982-2016 Advanced Engineering Software (aes)  
 Ver. 23.0 Release Date: 07/01/2016 License ID 1509

Analysis prepared by:

\*\*\*\*\* DESCRIPTION OF STUDY \*\*\*\*\*  
 \* NAKANO - PROPOSED CONDITION 4409 \*  
 \* SYSTEM 1000 END AT 1038 FOR DETENTION \*  
 \* 100 YEAR STORM EVENT \*  
 \*\*\*\*\*

FILE NAME: 1000P100.DAT  
 TIME/DATE OF STUDY: 09:46 06/14/2022

-----  
 USER SPECIFIED HYDROLOGY AND HYDRAULIC MODEL INFORMATION:  
 -----

2003 SAN DIEGO MANUAL CRITERIA

USER SPECIFIED STORM EVENT(YEAR) = 100.00  
 6-HOUR DURATION PRECIPITATION (INCHES) = 2.400  
 SPECIFIED MINIMUM PIPE SIZE(INCH) = 12.00  
 SPECIFIED PERCENT OF GRADIENTS(DECIMAL) TO USE FOR FRICTION SLOPE = 0.95  
 SAN DIEGO HYDROLOGY MANUAL "C"-VALUES USED FOR RATIONAL METHOD  
 \*CITY OF CHULA VISTA TIME-OF-CONCENTRATION MODEL SELECTED.\*  
 (BASED ON 07/2002 ADOPTED MANUAL)

NOTE: USE MODIFIED RATIONAL METHOD PROCEDURES FOR CONFLUENCE ANALYSIS

\*USER-DEFINED STREET-SECTIONS FOR COUPLED PIPEFLOW AND STREETFLOW MODEL\*

NO.	WIDTH (FT)	CROSSFALL (FT)	IN- / SIDE	OUT- / SIDE/ WAY	HEIGHT (FT)	WIDTH (FT)	LIP (FT)	HIKE (FT)	FACTOR (n)
1	14.5	8.0	0.018/0.018	0.020	0.50	1.50	0.0313	0.125	0.0150

GLOBAL STREET FLOW-DEPTH CONSTRAINTS:

- Relative Flow-Depth = 0.00 FEET  
 as (Maximum Allowable Street Flow Depth) - (Top-of-Curb)
  - (Depth)\*(Velocity) Constraint = 6.0 (FT\*FT/S)
- \*SIZE PIPE WITH A FLOW CAPACITY GREATER THAN OR EQUAL TO THE UPSTREAM TRIBUTARY PIPE.\*

\*\*\*\*\*

FLOW PROCESS FROM NODE 1000.00 TO NODE 1001.00 IS CODE = 21

-----  
 >>>>RATIONAL METHOD INITIAL SUBAREA ANALYSIS<<<<  
 -----

\*USER SPECIFIED(SUBAREA):  
 USER-SPECIFIED RUNOFF COEFFICIENT = .9000  
 INITIAL SUBAREA FLOW-LENGTH(FEET) = 123.00  
 UPSTREAM ELEVATION(FEET) = 193.00  
 DOWNSTREAM ELEVATION(FEET) = 184.00  
 ELEVATION DIFFERENCE(FEET) = 9.00  
 URBAN SUBAREA OVERLAND TIME OF FLOW(MIN.) = 1.854

1000P100.RES

WARNING: INITIAL SUBAREA FLOW PATH LENGTH IS GREATER THAN  
 THE MAXIMUM OVERLAND FLOW LENGTH = 100.00  
 (Reference: Table 3-1B of Hydrology Manual)  
 THE MAXIMUM OVERLAND FLOW LENGTH IS USED IN Tc CALCULATION!  
 100 YEAR RAINFALL INTENSITY(INCH/HOUR) = 6.323  
 NOTE: RAINFALL INTENSITY IS BASED ON Tc = 5-MINUTE.  
 SUBAREA RUNOFF(CFS) = 0.46  
 TOTAL AREA(ACRES) = 0.08 TOTAL RUNOFF(CFS) = 0.46

\*\*\*\*\*

FLOW PROCESS FROM NODE 1001.00 TO NODE 1002.00 IS CODE = 62

-----  
 >>>>COMPUTE STREET FLOW TRAVEL TIME THRU SUBAREA<<<<  
 >>>>(STREET TABLE SECTION # 1 USED)<<<<  
 -----

UPSTREAM ELEVATION(FEET) = 184.00 DOWNSTREAM ELEVATION(FEET) = 118.00  
 STREET LENGTH(FEET) = 713.50 CURB HEIGHT(INCHES) = 6.0  
 STREET HALFWIDTH(FEET) = 14.50

DISTANCE FROM CROWN TO CROSSFALL GRADEBREAK(FEET) = 8.00  
 INSIDE STREET CROSSFALL(DECIMAL) = 0.018  
 OUTSIDE STREET CROSSFALL(DECIMAL) = 0.018

SPECIFIED NUMBER OF HALFSTREETS CARRYING RUNOFF = 1  
 STREET PARKWAY CROSSFALL(DECIMAL) = 0.020  
 Manning's FRICTION FACTOR for Streetflow Section(curbs-to-curbs) = 0.0150  
 Manning's FRICTION FACTOR for Back-of-Walk Flow Section = 0.0200

\*\*TRAVEL TIME COMPUTED USING ESTIMATED FLOW(CFS) = 1.85  
 STREETFLOW MODEL RESULTS USING ESTIMATED FLOW:  
 STREET FLOW DEPTH(FEET) = 0.22  
 HALFSTREET FLOOD WIDTH(FEET) = 5.29  
 AVERAGE FLOW VELOCITY(FEET/SEC.) = 4.99  
 PRODUCT OF DEPTH&VELOCITY(FT\*FT/SEC.) = 1.12  
 STREET FLOW TRAVEL TIME(MIN.) = 2.38 Tc(MIN.) = 4.24  
 100 YEAR RAINFALL INTENSITY(INCH/HOUR) = 6.323

NOTE: RAINFALL INTENSITY IS BASED ON Tc = 5-MINUTE.

\*USER SPECIFIED(SUBAREA):

USER-SPECIFIED RUNOFF COEFFICIENT = .9000  
 AREA-AVERAGE RUNOFF COEFFICIENT = 0.900  
 SUBAREA AREA(ACRES) = 0.49 SUBAREA RUNOFF(CFS) = 2.79  
 TOTAL AREA(ACRES) = 0.6 PEAK FLOW RATE(CFS) = 3.24

END OF SUBAREA STREET FLOW HYDRAULICS:

DEPTH(FEET) = 0.26 HALFSTREET FLOOD WIDTH(FEET) = 7.22  
 FLOW VELOCITY(FEET/SEC.) = 5.54 DEPTH\*VELOCITY(FT\*FT/SEC.) = 1.43  
 LONGEST FLOWPATH FROM NODE 1000.00 TO NODE 1002.00 = 836.50 FEET.

\*\*\*\*\*

FLOW PROCESS FROM NODE 1002.00 TO NODE 1003.00 IS CODE = 31

-----  
 >>>>COMPUTE PIPE-FLOW TRAVEL TIME THRU SUBAREA<<<<  
 >>>>USING COMPUTER-ESTIMATED PIPESIZE (NON-PRESSURE FLOW)<<<<  
 -----

ELEVATION DATA: UPSTREAM(FEET) = 114.00 DOWNSTREAM(FEET) = 113.56  
 FLOW LENGTH(FEET) = 22.80 MANNING'S N = 0.013  
 DEPTH OF FLOW IN 12.0 INCH PIPE IS 7.2 INCHES  
 PIPE-FLOW VELOCITY(FEET/SEC.) = 6.58  
 ESTIMATED PIPE DIAMETER(INCH) = 12.00 NUMBER OF PIPES = 1  
 PIPE-FLOW(CFS) = 3.24  
 PIPE TRAVEL TIME(MIN.) = 0.06 Tc(MIN.) = 4.29  
 LONGEST FLOWPATH FROM NODE 1000.00 TO NODE 1003.00 = 859.30 FEET.



1000P100.RES

```

*****
FLOW PROCESS FROM NODE 1002.00 TO NODE 1003.00 IS CODE = 1
-----
>>>>DESIGNATE INDEPENDENT STREAM FOR CONFLUENCE<<<<
-----
TOTAL NUMBER OF STREAMS = 2
CONFLUENCE VALUES USED FOR INDEPENDENT STREAM 1 ARE:
TIME OF CONCENTRATION (MIN.) = 4.29
RAINFALL INTENSITY (INCH/HR) = 6.32
TOTAL STREAM AREA (ACRES) = 0.57
PEAK FLOW RATE (CFS) AT CONFLUENCE = 3.24

*****
FLOW PROCESS FROM NODE 1014.00 TO NODE 1015.00 IS CODE = 21
-----
>>>>RATIONAL METHOD INITIAL SUBAREA ANALYSIS<<<<
-----
*USER SPECIFIED (SUBAREA):
USER-SPECIFIED RUNOFF COEFFICIENT = .8500
INITIAL SUBAREA FLOW-LENGTH (FEET) = 146.70
UPSTREAM ELEVATION (FEET) = 193.00
DOWNSTREAM ELEVATION (FEET) = 184.00
ELEVATION DIFFERENCE (FEET) = 9.00
URBAN SUBAREA OVERLAND TIME OF FLOW (MIN.) = 2.458
WARNING: INITIAL SUBAREA FLOW PATH LENGTH IS GREATER THAN
THE MAXIMUM OVERLAND FLOW LENGTH = 100.00
(Reference: Table 3-1B of Hydrology Manual)
THE MAXIMUM OVERLAND FLOW LENGTH IS USED IN Tc CALCULATION!
100 YEAR RAINFALL INTENSITY (INCH/HOUR) = 6.323
NOTE: RAINFALL INTENSITY IS BASED ON Tc = 5-MINUTE.
SUBAREA RUNOFF (CFS) = 0.54
TOTAL AREA (ACRES) = 0.10 TOTAL RUNOFF (CFS) = 0.54

*****
FLOW PROCESS FROM NODE 1015.00 TO NODE 1016.00 IS CODE = 62
-----
>>>>COMPUTE STREET FLOW TRAVEL TIME THRU SUBAREA<<<<
>>>>(STREET TABLE SECTION # 1 USED)<<<<
-----
UPSTREAM ELEVATION (FEET) = 184.00 DOWNSTREAM ELEVATION (FEET) = 118.00
STREET LENGTH (FEET) = 668.70 CURB HEIGHT (INCHES) = 6.0
STREET HALFWIDTH (FEET) = 14.50

DISTANCE FROM CROWN TO CROSSFALL GRADEBREAK (FEET) = 8.00
INSIDE STREET CROSSFALL (DECIMAL) = 0.018
OUTSIDE STREET CROSSFALL (DECIMAL) = 0.018

SPECIFIED NUMBER OF HALFSTREETS CARRYING RUNOFF = 1
STREET PARKWAY CROSSFALL (DECIMAL) = 0.020
Manning's FRICTION FACTOR for Streetflow Section (curb-to-curb) = 0.0150
Manning's FRICTION FACTOR for Back-of-Walk Flow Section = 0.0200

**TRAVEL TIME COMPUTED USING ESTIMATED FLOW (CFS) = 1.67
STREETFLOW MODEL RESULTS USING ESTIMATED FLOW:
STREET FLOW DEPTH (FEET) = 0.22
HALFSTREET FLOOD WIDTH (FEET) = 4.90
AVERAGE FLOW VELOCITY (FEET/SEC.) = 4.98
PRODUCT OF DEPTH&VELOCITY (FT*FT/SEC.) = 1.08
STREET FLOW TRAVEL TIME (MIN.) = 2.24 Tc (MIN.) = 4.70
100 YEAR RAINFALL INTENSITY (INCH/HOUR) = 6.323
NOTE: RAINFALL INTENSITY IS BASED ON Tc = 5-MINUTE.
*USER SPECIFIED (SUBAREA):
USER-SPECIFIED RUNOFF COEFFICIENT = .8500

```

1000P100.RES

```

AREA-AVERAGE RUNOFF COEFFICIENT = 0.850
SUBAREA AREA (ACRES) = 0.42 SUBAREA RUNOFF (CFS) = 2.26
TOTAL AREA (ACRES) = 0.5 PEAK FLOW RATE (CFS) = 2.79

END OF SUBAREA STREET FLOW HYDRAULICS:
DEPTH (FEET) = 0.25 HALFSTREET FLOOD WIDTH (FEET) = 6.59
FLOW VELOCITY (FEET/SEC.) = 5.49 DEPTH*VELOCITY (FT*FT/SEC.) = 1.36
LONGEST FLOWPATH FROM NODE 1014.00 TO NODE 1016.00 = 815.40 FEET.

*****
FLOW PROCESS FROM NODE 1016.00 TO NODE 1003.00 IS CODE = 31
-----
>>>>COMPUTE PIPE-FLOW TRAVEL TIME THRU SUBAREA<<<<
>>>>USING COMPUTER-ESTIMATED PIPESIZE (NON-PRESSURE FLOW)<<<<
-----
ELEVATION DATA: UPSTREAM (FEET) = 114.00 DOWNSTREAM (FEET) = 113.66
FLOW LENGTH (FEET) = 8.10 MANNING'S N = 0.013
ESTIMATED PIPE DIAMETER (INCH) INCREASED TO 12.000
DEPTH OF FLOW IN 12.0 INCH PIPE IS 5.2 INCHES
PIPE-FLOW VELOCITY (FEET/SEC.) = 8.51
ESTIMATED PIPE DIAMETER (INCH) = 12.00 NUMBER OF PIPES = 1
PIPE-FLOW (CFS) = 2.79
PIPE TRAVEL TIME (MIN.) = 0.02 Tc (MIN.) = 4.71
LONGEST FLOWPATH FROM NODE 1014.00 TO NODE 1003.00 = 823.50 FEET.

*****
FLOW PROCESS FROM NODE 1016.00 TO NODE 1003.00 IS CODE = 1
-----
>>>>DESIGNATE INDEPENDENT STREAM FOR CONFLUENCE<<<<
>>>>AND COMPUTE VARIOUS CONFLUENCED STREAM VALUES<<<<
-----
TOTAL NUMBER OF STREAMS = 2
CONFLUENCE VALUES USED FOR INDEPENDENT STREAM 2 ARE:
TIME OF CONCENTRATION (MIN.) = 4.71
RAINFALL INTENSITY (INCH/HR) = 6.32
TOTAL STREAM AREA (ACRES) = 0.52
PEAK FLOW RATE (CFS) AT CONFLUENCE = 2.79

** CONFLUENCE DATA **
STREAM RUNOFF Tc INTENSITY AREA
NUMBER (CFS) (MIN.) (INCH/HOUR) (ACRE)
1 3.24 4.29 6.323 0.57
2 2.79 4.71 6.323 0.52

RAINFALL INTENSITY AND TIME OF CONCENTRATION RATIO
CONFLUENCE FORMULA USED FOR 2 STREAMS.

** PEAK FLOW RATE TABLE **
STREAM RUNOFF Tc INTENSITY
NUMBER (CFS) (MIN.) (INCH/HOUR)
1 5.79 4.29 6.323
2 6.04 4.71 6.323

COMPUTED CONFLUENCE ESTIMATES ARE AS FOLLOWS:
PEAK FLOW RATE (CFS) = 6.04 Tc (MIN.) = 4.71
TOTAL AREA (ACRES) = 1.1
LONGEST FLOWPATH FROM NODE 1000.00 TO NODE 1003.00 = 859.30 FEET.

*****
FLOW PROCESS FROM NODE 1003.00 TO NODE 1017.00 IS CODE = 31
-----
>>>>COMPUTE PIPE-FLOW TRAVEL TIME THRU SUBAREA<<<<
>>>>USING COMPUTER-ESTIMATED PIPESIZE (NON-PRESSURE FLOW)<<<<

```

## 1000P100.RES

## 1000P100.RES

```

=====
ELEVATION DATA: UPSTREAM(FEET) = 113.65 DOWNSTREAM(FEET) = 113.37
FLOW LENGTH(FEET) = 27.50 MANNING'S N = 0.013
DEPTH OF FLOW IN 15.0 INCH PIPE IS 11.7 INCHES
PIPE-FLOW VELOCITY(FEET/SEC.) = 5.89
ESTIMATED PIPE DIAMETER(INCH) = 15.00 NUMBER OF PIPES = 1
PIPE-FLOW(CFS) = 6.04
PIPE TRAVEL TIME(MIN.) = 0.08 Tc(MIN.) = 4.79
LONGEST FLOWPATH FROM NODE 1000.00 TO NODE 1017.00 = 886.80 FEET.
*****
FLOW PROCESS FROM NODE 1003.00 TO NODE 1017.00 IS CODE = 1
-----
>>>>DESIGNATE INDEPENDENT STREAM FOR CONFLUENCE<<<<
-----
TOTAL NUMBER OF STREAMS = 2
CONFLUENCE VALUES USED FOR INDEPENDENT STREAM 1 ARE:
TIME OF CONCENTRATION(MIN.) = 4.79
RAINFALL INTENSITY(INCH/HR) = 6.32
TOTAL STREAM AREA(ACRES) = 1.09
PEAK FLOW RATE(CFS) AT CONFLUENCE = 6.04
*****
FLOW PROCESS FROM NODE 1009.00 TO NODE 1010.00 IS CODE = 22
-----
>>>>RATIONAL METHOD INITIAL SUBAREA ANALYSIS<<<<
-----
*USER SPECIFIED(SUBAREA):
USER-SPECIFIED RUNOFF COEFFICIENT = .6000
USER SPECIFIED Tc(MIN.) = 5.000
100 YEAR RAINFALL INTENSITY(INCH/HOUR) = 6.323
SUBAREA RUNOFF(CFS) = 0.99
TOTAL AREA(ACRES) = 0.26 TOTAL RUNOFF(CFS) = 0.99
*****
FLOW PROCESS FROM NODE 1010.00 TO NODE 1011.00 IS CODE = 51
-----
>>>>COMPUTE TRAPEZOIDAL CHANNEL FLOW<<<<
>>>>TRAVELTIME THRU SUBAREA (EXISTING ELEMENT)<<<<
-----
ELEVATION DATA: UPSTREAM(FEET) = 206.00 DOWNSTREAM(FEET) = 146.00
CHANNEL LENGTH THRU SUBAREA(FEET) = 197.00 CHANNEL SLOPE = 0.3046
CHANNEL BASE(FEET) = 10.00 "Z" FACTOR = 50.000
MANNING'S FACTOR = 0.045 MAXIMUM DEPTH(FEET) = 2.00
100 YEAR RAINFALL INTENSITY(INCH/HOUR) = 5.526
*USER SPECIFIED(SUBAREA):
USER-SPECIFIED RUNOFF COEFFICIENT = .6000
TRAVEL TIME COMPUTED USING ESTIMATED FLOW(CFS) = 3.12
TRAVEL TIME THRU SUBAREA BASED ON VELOCITY(FEET/SEC.) = 2.83
AVERAGE FLOW DEPTH(FEET) = 0.08 TRAVEL TIME(MIN.) = 1.16
Tc(MIN.) = 6.16
SUBAREA AREA(ACRES) = 1.28 SUBAREA RUNOFF(CFS) = 4.24
AREA-AVERAGE RUNOFF COEFFICIENT = 0.600
TOTAL AREA(ACRES) = 1.5 PEAK FLOW RATE(CFS) = 5.11

END OF SUBAREA CHANNEL FLOW HYDRAULICS:
DEPTH(FEET) = 0.10 FLOW VELOCITY(FEET/SEC.) = 3.31
LONGEST FLOWPATH FROM NODE 1009.00 TO NODE 1011.00 = 865.70 FEET.
*****
FLOW PROCESS FROM NODE 1011.00 TO NODE 1012.00 IS CODE = 51
-----
>>>>COMPUTE TRAPEZOIDAL CHANNEL FLOW<<<<

```

```

>>>>TRAVELTIME THRU SUBAREA (EXISTING ELEMENT)<<<<
=====
ELEVATION DATA: UPSTREAM(FEET) = 146.00 DOWNSTREAM(FEET) = 132.00
CHANNEL LENGTH THRU SUBAREA(FEET) = 28.50 CHANNEL SLOPE = 0.4912
CHANNEL BASE(FEET) = 3.00 "Z" FACTOR = 3.000
MANNING'S FACTOR = 0.015 MAXIMUM DEPTH(FEET) = 0.50
CHANNEL FLOW THRU SUBAREA(CFS) = 5.11
FLOW VELOCITY(FEET/SEC.) = 14.83 FLOW DEPTH(FEET) = 0.10
TRAVEL TIME(MIN.) = 0.03 Tc(MIN.) = 6.19
LONGEST FLOWPATH FROM NODE 1009.00 TO NODE 1012.00 = 894.20 FEET.
*****
FLOW PROCESS FROM NODE 1012.00 TO NODE 1013.00 IS CODE = 81
-----
>>>>ADDITION OF SUBAREA TO MAINLINE PEAK FLOW<<<<
-----
100 YEAR RAINFALL INTENSITY(INCH/HOUR) = 5.508
*USER SPECIFIED(SUBAREA):
USER-SPECIFIED RUNOFF COEFFICIENT = .6000
AREA-AVERAGE RUNOFF COEFFICIENT = 0.6000
SUBAREA AREA(ACRES) = 0.41 SUBAREA RUNOFF(CFS) = 1.35
TOTAL AREA(ACRES) = 1.9 TOTAL RUNOFF(CFS) = 6.44
TC(MIN.) = 6.19
*****
FLOW PROCESS FROM NODE 1018.00 TO NODE 1013.00 IS CODE = 81
-----
>>>>ADDITION OF SUBAREA TO MAINLINE PEAK FLOW<<<<
-----
100 YEAR RAINFALL INTENSITY(INCH/HOUR) = 5.508
*USER SPECIFIED(SUBAREA):
USER-SPECIFIED RUNOFF COEFFICIENT = .6500
AREA-AVERAGE RUNOFF COEFFICIENT = 0.6078
SUBAREA AREA(ACRES) = 0.36 SUBAREA RUNOFF(CFS) = 1.29
TOTAL AREA(ACRES) = 2.3 TOTAL RUNOFF(CFS) = 7.73
TC(MIN.) = 6.19
*****
FLOW PROCESS FROM NODE 1013.00 TO NODE 1017.00 IS CODE = 31
-----
>>>>COMPUTE PIPE-FLOW TRAVEL TIME THRU SUBAREA<<<<
>>>>USING COMPUTER-ESTIMATED PIPESIZE (NON-PRESSURE FLOW)<<<<
=====
ELEVATION DATA: UPSTREAM(FEET) = 114.00 DOWNSTREAM(FEET) = 113.50
FLOW LENGTH(FEET) = 44.50 MANNING'S N = 0.013
DEPTH OF FLOW IN 18.0 INCH PIPE IS 11.2 INCHES
PIPE-FLOW VELOCITY(FEET/SEC.) = 6.67
ESTIMATED PIPE DIAMETER(INCH) = 18.00 NUMBER OF PIPES = 1
PIPE-FLOW(CFS) = 7.73
PIPE TRAVEL TIME(MIN.) = 0.11 Tc(MIN.) = 6.30
LONGEST FLOWPATH FROM NODE 1009.00 TO NODE 1017.00 = 938.70 FEET.
*****
FLOW PROCESS FROM NODE 1013.00 TO NODE 1017.00 IS CODE = 1
-----
>>>>DESIGNATE INDEPENDENT STREAM FOR CONFLUENCE<<<<
>>>>AND COMPUTE VARIOUS CONFLUENCED STREAM VALUES<<<<
-----
TOTAL NUMBER OF STREAMS = 2
CONFLUENCE VALUES USED FOR INDEPENDENT STREAM 2 ARE:
TIME OF CONCENTRATION(MIN.) = 6.30
RAINFALL INTENSITY(INCH/HR) = 5.45
TOTAL STREAM AREA(ACRES) = 2.31

```

1000P100.RES

PEAK FLOW RATE (CFS) AT CONFLUENCE = 7.73

\*\* CONFLUENCE DATA \*\*

STREAM NUMBER	RUNOFF (CFS)	Tc (MIN.)	INTENSITY (INCH/HOUR)	AREA (ACRE)
1	6.04	4.79	6.323	1.09
2	7.73	6.30	5.445	2.31

RAINFALL INTENSITY AND TIME OF CONCENTRATION RATIO  
CONFLUENCE FORMULA USED FOR 2 STREAMS.

\*\* PEAK FLOW RATE TABLE \*\*

STREAM NUMBER	RUNOFF (CFS)	Tc (MIN.)	INTENSITY (INCH/HOUR)
1	11.92	4.79	6.323
2	12.93	6.30	5.445

COMPUTED CONFLUENCE ESTIMATES ARE AS FOLLOWS:

PEAK FLOW RATE (CFS) = 12.93 Tc (MIN.) = 6.30  
TOTAL AREA (ACRES) = 3.4  
LONGEST FLOWPATH FROM NODE 1009.00 TO NODE 1017.00 = 938.70 FEET.

\*\*\*\*\*

FLOW PROCESS FROM NODE 1017.00 TO NODE 1020.00 IS CODE = 31

>>>>COMPUTE PIPE-FLOW TRAVEL TIME THRU SUBAREA<<<<<  
>>>>USING COMPUTER-ESTIMATED PIPESIZE (NON-PRESSURE FLOW)<<<<<

ELEVATION DATA: UPSTREAM (FEET) = 113.37 DOWNSTREAM (FEET) = 113.00  
FLOW LENGTH (FEET) = 139.00 MANNING'S N = 0.013  
DEPTH OF FLOW IN 27.0 INCH PIPE IS 18.8 INCHES  
PIPE-FLOW VELOCITY (FEET/SEC.) = 4.38  
ESTIMATED PIPE DIAMETER (INCH) = 27.00 NUMBER OF PIPES = 1  
PIPE-FLOW (CFS) = 12.93  
PIPE TRAVEL TIME (MIN.) = 0.53 Tc (MIN.) = 6.83  
LONGEST FLOWPATH FROM NODE 1009.00 TO NODE 1020.00 = 1077.70 FEET.

\*\*\*\*\*

FLOW PROCESS FROM NODE 1021.00 TO NODE 1020.00 IS CODE = 81

>>>>ADDITION OF SUBAREA TO MAINLINE PEAK FLOW<<<<<

100 YEAR RAINFALL INTENSITY (INCH/HOUR) = 5.169  
\*USER SPECIFIED (SUBAREA):  
USER-SPECIFIED RUNOFF COEFFICIENT = .6500  
AREA-AVERAGE RUNOFF COEFFICIENT = 0.6904  
SUBAREA AREA (ACRES) = 0.29 SUBAREA RUNOFF (CFS) = 0.97  
TOTAL AREA (ACRES) = 3.7 TOTAL RUNOFF (CFS) = 13.17  
Tc (MIN.) = 6.83

\*\*\*\*\*

FLOW PROCESS FROM NODE 1020.00 TO NODE 1022.00 IS CODE = 31

>>>>COMPUTE PIPE-FLOW TRAVEL TIME THRU SUBAREA<<<<<  
>>>>USING COMPUTER-ESTIMATED PIPESIZE (NON-PRESSURE FLOW)<<<<<

ELEVATION DATA: UPSTREAM (FEET) = 113.00 DOWNSTREAM (FEET) = 111.40  
FLOW LENGTH (FEET) = 160.00 MANNING'S N = 0.013  
DEPTH OF FLOW IN 21.0 INCH PIPE IS 14.9 INCHES  
PIPE-FLOW VELOCITY (FEET/SEC.) = 7.21  
ESTIMATED PIPE DIAMETER (INCH) = 21.00 NUMBER OF PIPES = 1  
PIPE-FLOW (CFS) = 13.17  
PIPE TRAVEL TIME (MIN.) = 0.37 Tc (MIN.) = 7.20

1000P100.RES

LONGEST FLOWPATH FROM NODE 1009.00 TO NODE 1022.00 = 1237.70 FEET.

\*\*\*\*\*

FLOW PROCESS FROM NODE 1022.00 TO NODE 1022.00 IS CODE = 1

>>>>DESIGNATE INDEPENDENT STREAM FOR CONFLUENCE<<<<<

TOTAL NUMBER OF STREAMS = 3  
CONFLUENCE VALUES USED FOR INDEPENDENT STREAM 1 ARE:  
TIME OF CONCENTRATION (MIN.) = 7.20  
RAINFALL INTENSITY (INCH/HR) = 5.00  
TOTAL STREAM AREA (ACRES) = 3.69  
PEAK FLOW RATE (CFS) AT CONFLUENCE = 13.17

\*\*\*\*\*

FLOW PROCESS FROM NODE 1023.00 TO NODE 1024.00 IS CODE = 21

>>>>RATIONAL METHOD INITIAL SUBAREA ANALYSIS<<<<<

\*USER SPECIFIED (SUBAREA):  
USER-SPECIFIED RUNOFF COEFFICIENT = .6500  
INITIAL SUBAREA FLOW-LENGTH (FEET) = 114.70  
UPSTREAM ELEVATION (FEET) = 116.90  
DOWNSTREAM ELEVATION (FEET) = 114.90  
ELEVATION DIFFERENCE (FEET) = 2.00  
URBAN SUBAREA OVERLAND TIME OF FLOW (MIN.) = 5.922  
WARNING: INITIAL SUBAREA FLOW PATH LENGTH IS GREATER THAN  
THE MAXIMUM OVERLAND FLOW LENGTH = 77.44  
(Reference: Table 3-1B of Hydrology Manual)  
THE MAXIMUM OVERLAND FLOW LENGTH IS USED IN Tc CALCULATION!  
100 YEAR RAINFALL INTENSITY (INCH/HOUR) = 5.669  
SUBAREA RUNOFF (CFS) = 0.74  
TOTAL AREA (ACRES) = 0.20 TOTAL RUNOFF (CFS) = 0.74

\*\*\*\*\*

FLOW PROCESS FROM NODE 1024.00 TO NODE 1025.00 IS CODE = 62

>>>>COMPUTE STREET FLOW TRAVEL TIME THRU SUBAREA<<<<<  
>>>>(STREET TABLE SECTION # 1 USED)<<<<<

UPSTREAM ELEVATION (FEET) = 114.90 DOWNSTREAM ELEVATION (FEET) = 110.90  
STREET LENGTH (FEET) = 222.90 CURB HEIGHT (INCHES) = 6.0  
STREET HALFWIDTH (FEET) = 14.50

DISTANCE FROM CROWN TO CROSSFALL GRADEBREAK (FEET) = 8.00  
INSIDE STREET CROSSFALL (DECIMAL) = 0.018  
OUTSIDE STREET CROSSFALL (DECIMAL) = 0.018

SPECIFIED NUMBER OF HALFSTREETS CARRYING RUNOFF = 1  
STREET PARKWAY CROSSFALL (DECIMAL) = 0.020  
Manning's FRICTION FACTOR for Streetflow Section (curb-to-curb) = 0.0150  
Manning's FRICTION FACTOR for Back-of-Walk Flow Section = 0.0200

\*\*TRAVEL TIME COMPUTED USING ESTIMATED FLOW (CFS) = 1.76  
STREETFLOW MODEL RESULTS USING ESTIMATED FLOW:  
STREET FLOW DEPTH (FEET) = 0.27  
HALFSTREET FLOOD WIDTH (FEET) = 8.03  
AVERAGE FLOW VELOCITY (FEET/SEC.) = 2.53  
PRODUCT OF DEPTH&VELOCITY (FT\*FT/SEC.) = 0.69  
STREET FLOW TRAVEL TIME (MIN.) = 1.47 Tc (MIN.) = 7.39  
100 YEAR RAINFALL INTENSITY (INCH/HOUR) = 4.914  
\*USER SPECIFIED (SUBAREA):  
USER-SPECIFIED RUNOFF COEFFICIENT = .6500

1000P100.RES

AREA-AVERAGE RUNOFF COEFFICIENT = 0.650  
 SUBAREA AREA (ACRES) = 0.64 SUBAREA RUNOFF (CFS) = 2.04  
 TOTAL AREA (ACRES) = 0.8 PEAK FLOW RATE (CFS) = 2.68

END OF SUBAREA STREET FLOW HYDRAULICS:  
 DEPTH (FEET) = 0.30 HALFSTREET FLOOD WIDTH (FEET) = 9.72  
 FLOW VELOCITY (FEET/SEC.) = 2.78 DEPTH\*VELOCITY (FT\*FT/SEC.) = 0.84  
 LONGEST FLOWPATH FROM NODE 1023.00 TO NODE 1025.00 = 337.60 FEET.

\*\*\*\*\*  
 FLOW PROCESS FROM NODE 1025.00 TO NODE 1022.00 IS CODE = 31

>>>>COMPUTE PIPE-FLOW TRAVEL TIME THRU SUBAREA<<<<<  
 >>>>USING COMPUTER-ESTIMATED PIPESIZE (NON-PRESSURE FLOW)<<<<<

=====

ELEVATION DATA: UPSTREAM (FEET) = 108.00 DOWNSTREAM (FEET) = 107.50  
 FLOW LENGTH (FEET) = 7.81 MANNING'S N = 0.013  
 ESTIMATED PIPE DIAMETER (INCH) INCREASED TO 12.000  
 DEPTH OF FLOW IN 12.0 INCH PIPE IS 4.6 INCHES  
 PIPE-FLOW VELOCITY (FEET/SEC.) = 9.83  
 ESTIMATED PIPE DIAMETER (INCH) = 12.00 NUMBER OF PIPES = 1  
 PIPE-FLOW (CFS) = 2.68  
 PIPE TRAVEL TIME (MIN.) = 0.01 Tc (MIN.) = 7.40  
 LONGEST FLOWPATH FROM NODE 1023.00 TO NODE 1022.00 = 345.41 FEET.

\*\*\*\*\*  
 FLOW PROCESS FROM NODE 1025.00 TO NODE 1022.00 IS CODE = 1

>>>>DESIGNATE INDEPENDENT STREAM FOR CONFLUENCE<<<<<

=====

TOTAL NUMBER OF STREAMS = 3  
 CONFLUENCE VALUES USED FOR INDEPENDENT STREAM 2 ARE:  
 TIME OF CONCENTRATION (MIN.) = 7.40  
 RAINFALL INTENSITY (INCH/HR) = 4.91  
 TOTAL STREAM AREA (ACRES) = 0.84  
 PEAK FLOW RATE (CFS) AT CONFLUENCE = 2.68

\*\*\*\*\*  
 FLOW PROCESS FROM NODE 1019.00 TO NODE 1026.00 IS CODE = 21

>>>>RATIONAL METHOD INITIAL SUBAREA ANALYSIS<<<<<

=====

\*USER SPECIFIED (SUBAREA):  
 USER-SPECIFIED RUNOFF COEFFICIENT = .6500  
 INITIAL SUBAREA FLOW-LENGTH (FEET) = 117.20  
 UPSTREAM ELEVATION (FEET) = 115.70  
 DOWNSTREAM ELEVATION (FEET) = 113.60  
 ELEVATION DIFFERENCE (FEET) = 2.10  
 URBAN SUBAREA OVERLAND TIME OF FLOW (MIN.) = 5.887  
 WARNING: INITIAL SUBAREA FLOW PATH LENGTH IS GREATER THAN  
 THE MAXIMUM OVERLAND FLOW LENGTH = 77.92  
 (Reference: Table 3-1B of Hydrology Manual)  
 THE MAXIMUM OVERLAND FLOW LENGTH IS USED IN Tc CALCULATION!  
 100 YEAR RAINFALL INTENSITY (INCH/HOUR) = 5.691  
 SUBAREA RUNOFF (CFS) = 0.85  
 TOTAL AREA (ACRES) = 0.23 TOTAL RUNOFF (CFS) = 0.85

\*\*\*\*\*  
 FLOW PROCESS FROM NODE 1026.00 TO NODE 1027.00 IS CODE = 62

>>>>COMPUTE STREET FLOW TRAVEL TIME THRU SUBAREA<<<<<  
 >>>>(STREET TABLE SECTION # 1 USED)<<<<<

1000P100.RES

UPSTREAM ELEVATION (FEET) = 114.60 DOWNSTREAM ELEVATION (FEET) = 110.90  
 STREET LENGTH (FEET) = 234.70 CURB HEIGHT (INCHES) = 6.0  
 STREET HALFWIDTH (FEET) = 14.50

DISTANCE FROM CROWN TO CROSSFALL GRADEBREAK (FEET) = 8.00  
 INSIDE STREET CROSSFALL (DECIMAL) = 0.018  
 OUTSIDE STREET CROSSFALL (DECIMAL) = 0.018

SPECIFIED NUMBER OF HALFSTREETS CARRYING RUNOFF = 1  
 STREET PARKWAY CROSSFALL (DECIMAL) = 0.020  
 Manning's FRICTION FACTOR for Streetflow Section (curb-to-curb) = 0.0150  
 Manning's FRICTION FACTOR for Back-of-Walk Flow Section = 0.0200

\*\*TRAVEL TIME COMPUTED USING ESTIMATED FLOW (CFS) = 2.16

STREETFLOW MODEL RESULTS USING ESTIMATED FLOW:  
 STREET FLOW DEPTH (FEET) = 0.29  
 HALFSTREET FLOOD WIDTH (FEET) = 9.09  
 AVERAGE FLOW VELOCITY (FEET/SEC.) = 2.51  
 PRODUCT OF DEPTH&VELOCITY (FT\*FT/SEC.) = 0.73  
 STREET FLOW TRAVEL TIME (MIN.) = 1.56 Tc (MIN.) = 7.44  
 100 YEAR RAINFALL INTENSITY (INCH/HOUR) = 4.892

\*USER SPECIFIED (SUBAREA):  
 USER-SPECIFIED RUNOFF COEFFICIENT = .6500  
 AREA-AVERAGE RUNOFF COEFFICIENT = 0.650  
 SUBAREA AREA (ACRES) = 0.82 SUBAREA RUNOFF (CFS) = 2.61  
 TOTAL AREA (ACRES) = 1.0 PEAK FLOW RATE (CFS) = 3.34

END OF SUBAREA STREET FLOW HYDRAULICS:  
 DEPTH (FEET) = 0.33 HALFSTREET FLOOD WIDTH (FEET) = 10.97  
 FLOW VELOCITY (FEET/SEC.) = 2.79 DEPTH\*VELOCITY (FT\*FT/SEC.) = 0.91  
 LONGEST FLOWPATH FROM NODE 1019.00 TO NODE 1027.00 = 351.90 FEET.

\*\*\*\*\*  
 FLOW PROCESS FROM NODE 1027.00 TO NODE 1022.00 IS CODE = 31

>>>>COMPUTE PIPE-FLOW TRAVEL TIME THRU SUBAREA<<<<<  
 >>>>USING COMPUTER-ESTIMATED PIPESIZE (NON-PRESSURE FLOW)<<<<<

=====

ELEVATION DATA: UPSTREAM (FEET) = 108.00 DOWNSTREAM (FEET) = 107.50  
 FLOW LENGTH (FEET) = 22.60 MANNING'S N = 0.013  
 DEPTH OF FLOW IN 12.0 INCH PIPE IS 7.0 INCHES  
 PIPE-FLOW VELOCITY (FEET/SEC.) = 6.99  
 ESTIMATED PIPE DIAMETER (INCH) = 12.00 NUMBER OF PIPES = 1  
 PIPE-FLOW (CFS) = 3.34  
 PIPE TRAVEL TIME (MIN.) = 0.05 Tc (MIN.) = 7.50  
 LONGEST FLOWPATH FROM NODE 1019.00 TO NODE 1022.00 = 374.50 FEET.

\*\*\*\*\*  
 FLOW PROCESS FROM NODE 1027.00 TO NODE 1022.00 IS CODE = 1

>>>>DESIGNATE INDEPENDENT STREAM FOR CONFLUENCE<<<<<  
 >>>>AND COMPUTE VARIOUS CONFLUENCED STREAM VALUES<<<<<

=====

TOTAL NUMBER OF STREAMS = 3  
 CONFLUENCE VALUES USED FOR INDEPENDENT STREAM 3 ARE:  
 TIME OF CONCENTRATION (MIN.) = 7.50  
 RAINFALL INTENSITY (INCH/HR) = 4.87  
 TOTAL STREAM AREA (ACRES) = 1.05  
 PEAK FLOW RATE (CFS) AT CONFLUENCE = 3.34

\*\* CONFLUENCE DATA \*\*

STREAM NUMBER	RUNOFF (CFS)	Tc (MIN.)	INTENSITY (INCH/HOUR)	AREA (ACRE)

1000P100.RES

1	13.17	7.20	4.997	3.69
2	2.68	7.40	4.909	0.84
3	3.34	7.50	4.869	1.05

RAINFALL INTENSITY AND TIME OF CONCENTRATION RATIO  
CONFLUENCE FORMULA USED FOR 3 STREAMS.

\*\* PEAK FLOW RATE TABLE \*\*

STREAM NUMBER	RUNOFF (CFS)	Tc (MIN.)	INTENSITY (INCH/HOUR)
1	18.99	7.20	4.997
2	18.92	7.40	4.909
3	18.83	7.50	4.869

COMPUTED CONFLUENCE ESTIMATES ARE AS FOLLOWS:  
PEAK FLOW RATE (CFS) = 18.99 Tc (MIN.) = 7.20  
TOTAL AREA (ACRES) = 5.6  
LONGEST FLOWPATH FROM NODE 1009.00 TO NODE 1022.00 = 1237.70 FEET.

\*\*\*\*\*  
FLOW PROCESS FROM NODE 1022.00 TO NODE 1028.00 IS CODE = 31

>>>>COMPUTE PIPE-FLOW TRAVEL TIME THRU SUBAREA<<<<<  
>>>>USING COMPUTER-ESTIMATED PIPESIZE (NON-PRESSURE FLOW)<<<<<

ELEVATION DATA: UPSTREAM (FEET) = 107.50 DOWNSTREAM (FEET) = 105.90  
FLOW LENGTH (FEET) = 159.00 MANNING'S N = 0.013  
DEPTH OF FLOW IN 24.0 INCH PIPE IS 17.1 INCHES  
PIPE-FLOW VELOCITY (FEET/SEC.) = 7.92  
ESTIMATED PIPE DIAMETER (INCH) = 24.00 NUMBER OF PIPES = 1  
PIPE-FLOW (CFS) = 18.99  
PIPE TRAVEL TIME (MIN.) = 0.33 Tc (MIN.) = 7.54  
LONGEST FLOWPATH FROM NODE 1009.00 TO NODE 1028.00 = 1396.70 FEET.

\*\*\*\*\*  
FLOW PROCESS FROM NODE 1022.00 TO NODE 1028.00 IS CODE = 1

>>>>DESIGNATE INDEPENDENT STREAM FOR CONFLUENCE<<<<<

TOTAL NUMBER OF STREAMS = 2  
CONFLUENCE VALUES USED FOR INDEPENDENT STREAM 1 ARE:  
TIME OF CONCENTRATION (MIN.) = 7.54  
RAINFALL INTENSITY (INCH/HR) = 4.85  
TOTAL STREAM AREA (ACRES) = 5.58  
PEAK FLOW RATE (CFS) AT CONFLUENCE = 18.99

\*\*\*\*\*  
FLOW PROCESS FROM NODE 1029.00 TO NODE 1030.00 IS CODE = 21

>>>>RATIONAL METHOD INITIAL SUBAREA ANALYSIS<<<<<

\*USER SPECIFIED (SUBAREA):  
USER-SPECIFIED RUNOFF COEFFICIENT = .6500  
INITIAL SUBAREA FLOW-LENGTH (FEET) = 118.00  
UPSTREAM ELEVATION (FEET) = 113.20  
DOWNSTREAM ELEVATION (FEET) = 110.60  
ELEVATION DIFFERENCE (FEET) = 2.60  
URBAN SUBAREA OVERLAND TIME OF FLOW (MIN.) = 5.673  
WARNING: INITIAL SUBAREA FLOW PATH LENGTH IS GREATER THAN  
THE MAXIMUM OVERLAND FLOW LENGTH = 83.05  
(Reference: Table 3-1B of Hydrology Manual)  
THE MAXIMUM OVERLAND FLOW LENGTH IS USED IN Tc CALCULATION!  
100 YEAR RAINFALL INTENSITY (INCH/HOUR) = 5.829

1000P100.RES

SUBAREA RUNOFF (CFS) = 0.64  
TOTAL AREA (ACRES) = 0.17 TOTAL RUNOFF (CFS) = 0.64

\*\*\*\*\*  
FLOW PROCESS FROM NODE 1030.00 TO NODE 1031.00 IS CODE = 62

>>>>COMPUTE STREET FLOW TRAVEL TIME THRU SUBAREA<<<<<  
>>>>(STREET TABLE SECTION # 1 USED)<<<<<

UPSTREAM ELEVATION (FEET) = 111.60 DOWNSTREAM ELEVATION (FEET) = 107.60  
STREET LENGTH (FEET) = 270.20 CURB HEIGHT (INCHES) = 6.0  
STREET HALFWIDTH (FEET) = 14.50

DISTANCE FROM CROWN TO CROSSFALL GRADEBREAK (FEET) = 8.00  
INSIDE STREET CROSSFALL (DECIMAL) = 0.018  
OUTSIDE STREET CROSSFALL (DECIMAL) = 0.018

SPECIFIED NUMBER OF HALFSTREETS CARRYING RUNOFF = 1  
STREET PARKWAY CROSSFALL (DECIMAL) = 0.020  
Manning's FRICTION FACTOR for Streetflow Section (curb-to-curb) = 0.0150  
Manning's FRICTION FACTOR for Back-of-Walk Flow Section = 0.0200

\*TRAVEL TIME COMPUTED USING ESTIMATED FLOW (CFS) = 1.71  
STREETFLOW MODEL RESULTS USING ESTIMATED FLOW:  
STREET FLOW DEPTH (FEET) = 0.28  
HALFSTREET FLOOD WIDTH (FEET) = 8.28  
AVERAGE FLOW VELOCITY (FEET/SEC.) = 2.34  
PRODUCT OF DEPTH&VELOCITY (FT\*FT/SEC.) = 0.65  
STREET FLOW TRAVEL TIME (MIN.) = 1.93 Tc (MIN.) = 7.60  
100 YEAR RAINFALL INTENSITY (INCH/HOUR) = 4.828  
\*USER SPECIFIED (SUBAREA):  
USER-SPECIFIED RUNOFF COEFFICIENT = .6500  
AREA-AVERAGE RUNOFF COEFFICIENT = 0.650  
SUBAREA AREA (ACRES) = 0.68 SUBAREA RUNOFF (CFS) = 2.13  
TOTAL AREA (ACRES) = 0.9 PEAK FLOW RATE (CFS) = 2.67

END OF SUBAREA STREET FLOW HYDRAULICS:  
DEPTH (FEET) = 0.31 HALFSTREET FLOOD WIDTH (FEET) = 10.09  
FLOW VELOCITY (FEET/SEC.) = 2.59 DEPTH\*VELOCITY (FT\*FT/SEC.) = 0.80  
LONGEST FLOWPATH FROM NODE 1029.00 TO NODE 1031.00 = 388.20 FEET.

\*\*\*\*\*  
FLOW PROCESS FROM NODE 1031.00 TO NODE 1028.00 IS CODE = 31

>>>>COMPUTE PIPE-FLOW TRAVEL TIME THRU SUBAREA<<<<<  
>>>>USING COMPUTER-ESTIMATED PIPESIZE (NON-PRESSURE FLOW)<<<<<

ELEVATION DATA: UPSTREAM (FEET) = 106.20 DOWNSTREAM (FEET) = 105.90  
FLOW LENGTH (FEET) = 7.80 MANNING'S N = 0.013  
ESTIMATED PIPE DIAMETER (INCH) INCREASED TO 12.000  
DEPTH OF FLOW IN 12.0 INCH PIPE IS 5.2 INCHES  
PIPE-FLOW VELOCITY (FEET/SEC.) = 8.15  
ESTIMATED PIPE DIAMETER (INCH) = 12.00 NUMBER OF PIPES = 1  
PIPE-FLOW (CFS) = 2.67  
PIPE TRAVEL TIME (MIN.) = 0.02 Tc (MIN.) = 7.61  
LONGEST FLOWPATH FROM NODE 1029.00 TO NODE 1028.00 = 396.00 FEET.

\*\*\*\*\*  
FLOW PROCESS FROM NODE 1031.00 TO NODE 1028.00 IS CODE = 1

>>>>DESIGNATE INDEPENDENT STREAM FOR CONFLUENCE<<<<<  
>>>>AND COMPUTE VARIOUS CONFLUENCED STREAM VALUES<<<<<

1000P100.RES

TOTAL NUMBER OF STREAMS = 2  
 CONFLUENCE VALUES USED FOR INDEPENDENT STREAM 2 ARE:  
 TIME OF CONCENTRATION (MIN.) = 7.61  
 RAINFALL INTENSITY (INCH/HR) = 4.82  
 TOTAL STREAM AREA (ACRES) = 0.85  
 PEAK FLOW RATE (CFS) AT CONFLUENCE = 2.67

\*\* CONFLUENCE DATA \*\*

STREAM NUMBER	RUNOFF (CFS)	Tc (MIN.)	INTENSITY (INCH/HOUR)	AREA (ACRE)
1	18.99	7.54	4.852	5.58
2	2.67	7.61	4.821	0.85

RAINFALL INTENSITY AND TIME OF CONCENTRATION RATIO  
 CONFLUENCE FORMULA USED FOR 2 STREAMS.

\*\* PEAK FLOW RATE TABLE \*\*

STREAM NUMBER	RUNOFF (CFS)	Tc (MIN.)	INTENSITY (INCH/HOUR)
1	21.63	7.54	4.852
2	21.53	7.61	4.821

COMPUTED CONFLUENCE ESTIMATES ARE AS FOLLOWS:  
 PEAK FLOW RATE (CFS) = 21.63 Tc (MIN.) = 7.54  
 TOTAL AREA (ACRES) = 6.4  
 LONGEST FLOWPATH FROM NODE 1009.00 TO NODE 1028.00 = 1396.70 FEET.

\*\*\*\*\*  
 FLOW PROCESS FROM NODE 1033.00 TO NODE 1028.00 IS CODE = 81

>>>>ADDITION OF SUBAREA TO MAINLINE PEAK FLOW<<<<

=====

100 YEAR RAINFALL INTENSITY (INCH/HOUR) = 4.852  
 \*USER SPECIFIED (SUBAREA):  
 USER-SPECIFIED RUNOFF COEFFICIENT = .6500  
 AREA-AVERAGE RUNOFF COEFFICIENT = 0.6701  
 SUBAREA AREA (ACRES) = 0.99 SUBAREA RUNOFF (CFS) = 3.12  
 TOTAL AREA (ACRES) = 7.4 TOTAL RUNOFF (CFS) = 24.13  
 Tc (MIN.) = 7.54

\*\*\*\*\*  
 FLOW PROCESS FROM NODE 1028.00 TO NODE 1005.00 IS CODE = 31

>>>>COMPUTE PIPE-FLOW TRAVEL TIME THRU SUBAREA<<<<  
 >>>>USING COMPUTER-ESTIMATED PIPESIZE (NON-PRESSURE FLOW)<<<<

=====

ELEVATION DATA: UPSTREAM (FEET) = 105.90 DOWNSTREAM (FEET) = 103.20  
 FLOW LENGTH (FEET) = 122.00 MANNING'S N = 0.013  
 DEPTH OF FLOW IN 24.0 INCH PIPE IS 15.3 INCHES  
 PIPE-FLOW VELOCITY (FEET/SEC.) = 11.42  
 ESTIMATED PIPE DIAMETER (INCH) = 24.00 NUMBER OF PIPES = 1  
 PIPE-FLOW (CFS) = 24.13  
 PIPE TRAVEL TIME (MIN.) = 0.18 Tc (MIN.) = 7.72  
 LONGEST FLOWPATH FROM NODE 1009.00 TO NODE 1005.00 = 1518.70 FEET.

\*\*\*\*\*  
 FLOW PROCESS FROM NODE 1028.00 TO NODE 1005.00 IS CODE = 1

>>>>DESIGNATE INDEPENDENT STREAM FOR CONFLUENCE<<<<

=====

TOTAL NUMBER OF STREAMS = 2  
 CONFLUENCE VALUES USED FOR INDEPENDENT STREAM 1 ARE:  
 TIME OF CONCENTRATION (MIN.) = 7.72

1000P100.RES

RAINFALL INTENSITY (INCH/HR) = 4.78  
 TOTAL STREAM AREA (ACRES) = 7.42  
 PEAK FLOW RATE (CFS) AT CONFLUENCE = 24.13

\*\*\*\*\*  
 FLOW PROCESS FROM NODE 1036.00 TO NODE 1037.00 IS CODE = 21

>>>>RATIONAL METHOD INITIAL SUBAREA ANALYSIS<<<<

=====

\*USER SPECIFIED (SUBAREA):  
 USER-SPECIFIED RUNOFF COEFFICIENT = .6500  
 INITIAL SUBAREA FLOW-LENGTH (FEET) = 118.00  
 UPSTREAM ELEVATION (FEET) = 113.30  
 DOWNSTREAM ELEVATION (FEET) = 111.70  
 ELEVATION DIFFERENCE (FEET) = 1.60  
 URBAN SUBAREA OVERLAND TIME OF FLOW (MIN.) = 6.277  
 WARNING: INITIAL SUBAREA FLOW PATH LENGTH IS GREATER THAN  
 THE MAXIMUM OVERLAND FLOW LENGTH = 73.56  
 (Reference: Table 3-1B of Hydrology Manual)  
 THE MAXIMUM OVERLAND FLOW LENGTH IS USED IN Tc CALCULATION!  
 100 YEAR RAINFALL INTENSITY (INCH/HOUR) = 5.461  
 SUBAREA RUNOFF (CFS) = 0.43  
 TOTAL AREA (ACRES) = 0.12 TOTAL RUNOFF (CFS) = 0.43

\*\*\*\*\*  
 FLOW PROCESS FROM NODE 1037.00 TO NODE 1040.00 IS CODE = 62

>>>>COMPUTE STREET FLOW TRAVEL TIME THRU SUBAREA<<<<  
 >>>>(STREET TABLE SECTION # 1 USED)<<<<

=====

UPSTREAM ELEVATION (FEET) = 111.70 DOWNSTREAM ELEVATION (FEET) = 107.90  
 STREET LENGTH (FEET) = 369.50 CURB HEIGHT (INCHES) = 6.0  
 STREET HALFWIDTH (FEET) = 14.50

DISTANCE FROM CROWN TO CROSSFALL GRADEBREAK (FEET) = 8.00  
 INSIDE STREET CROSSFALL (DECIMAL) = 0.018  
 OUTSIDE STREET CROSSFALL (DECIMAL) = 0.018

SPECIFIED NUMBER OF HALFSTREETS CARRYING RUNOFF = 1  
 STREET PARKWAY CROSSFALL (DECIMAL) = 0.020  
 Manning's FRICTION FACTOR for Streetflow Section (curb-to-curb) = 0.0150  
 Manning's FRICTION FACTOR for Back-of-Walk Flow Section = 0.0200

\*TRAVEL TIME COMPUTED USING ESTIMATED FLOW (CFS) = 1.26

STREETFLOW MODEL RESULTS USING ESTIMATED FLOW:  
 STREET FLOW DEPTH (FEET) = 0.27  
 HALFSTREET FLOOD WIDTH (FEET) = 7.78  
 AVERAGE FLOW VELOCITY (FEET/SEC.) = 1.90  
 PRODUCT OF DEPTH&VELOCITY (FT\*FT/SEC.) = 0.51  
 STREET FLOW TRAVEL TIME (MIN.) = 3.23 Tc (MIN.) = 9.51  
 100 YEAR RAINFALL INTENSITY (INCH/HOUR) = 4.177

\*USER SPECIFIED (SUBAREA):  
 USER-SPECIFIED RUNOFF COEFFICIENT = .6500  
 AREA-AVERAGE RUNOFF COEFFICIENT = 0.650  
 SUBAREA AREA (ACRES) = 0.61 SUBAREA RUNOFF (CFS) = 1.66  
 TOTAL AREA (ACRES) = 0.7 PEAK FLOW RATE (CFS) = 1.98

END OF SUBAREA STREET FLOW HYDRAULICS:  
 DEPTH (FEET) = 0.30 HALFSTREET FLOOD WIDTH (FEET) = 9.59  
 FLOW VELOCITY (FEET/SEC.) = 2.10 DEPTH\*VELOCITY (FT\*FT/SEC.) = 0.63  
 LONGEST FLOWPATH FROM NODE 1036.00 TO NODE 1040.00 = 487.50 FEET.

\*\*\*\*\*

1000P100.RES

```

FLOW PROCESS FROM NODE 1039.00 TO NODE 1040.00 IS CODE = 81
-----
>>>>ADDITION OF SUBAREA TO MAINLINE PEAK FLOW<<<<
=====
100 YEAR RAINFALL INTENSITY(INCH/HOUR) = 4.177
*USER SPECIFIED(SUBAREA):
USER-SPECIFIED RUNOFF COEFFICIENT = .6500
AREA-AVERAGE RUNOFF COEFFICIENT = 0.6500
SUBAREA AREA(ACRES) = 0.80 SUBAREA RUNOFF(CFS) = 2.17
TOTAL AREA(ACRES) = 1.5 TOTAL RUNOFF(CFS) = 4.15
TC(MIN.) = 9.51

*****
FLOW PROCESS FROM NODE 1040.00 TO NODE 1005.00 IS CODE = 31
-----
>>>>COMPUTE PIPE-FLOW TRAVEL TIME THRU SUBAREA<<<<
>>>>USING COMPUTER-ESTIMATED PIPESIZE (NON-PRESSURE FLOW)<<<<
=====
ELEVATION DATA: UPSTREAM(FEET) = 105.50 DOWNSTREAM(FEET) = 103.47
FLOW LENGTH(FEET) = 201.00 MANNING'S N = 0.013
DEPTH OF FLOW IN 15.0 INCH PIPE IS 8.9 INCHES
PIPE-FLOW VELOCITY(FEET/SEC.) = 5.50
ESTIMATED PIPE DIAMETER(INCH) = 15.00 NUMBER OF PIPES = 1
PIPE-FLOW(CFS) = 4.15
PIPE TRAVEL TIME(MIN.) = 0.61 Tc(MIN.) = 10.12
LONGEST FLOWPATH FROM NODE 1036.00 TO NODE 1005.00 = 688.50 FEET.

*****
FLOW PROCESS FROM NODE 1040.00 TO NODE 1005.00 IS CODE = 1
-----
>>>>DESIGNATE INDEPENDENT STREAM FOR CONFLUENCE<<<<
>>>>AND COMPUTE VARIOUS CONFLUENCED STREAM VALUES<<<<
=====
TOTAL NUMBER OF STREAMS = 2
CONFLUENCE VALUES USED FOR INDEPENDENT STREAM 2 ARE:
TIME OF CONCENTRATION(MIN.) = 10.12
RAINFALL INTENSITY(INCH/HR) = 4.01
TOTAL STREAM AREA(ACRES) = 1.53
PEAK FLOW RATE(CFS) AT CONFLUENCE = 4.15

** CONFLUENCE DATA **
STREAM RUNOFF Tc INTENSITY AREA
NUMBER (CFS) (MIN.) (INCH/HOUR) (ACRE)
1 24.13 7.72 4.780 7.42
2 4.15 10.12 4.013 1.53

RAINFALL INTENSITY AND TIME OF CONCENTRATION RATIO
CONFLUENCE FORMULA USED FOR 2 STREAMS.

** PEAK FLOW RATE TABLE **
STREAM RUNOFF Tc INTENSITY
NUMBER (CFS) (MIN.) (INCH/HOUR)
1 27.29 7.72 4.780
2 24.41 10.12 4.013

COMPUTED CONFLUENCE ESTIMATES ARE AS FOLLOWS:
PEAK FLOW RATE(CFS) = 27.29 Tc(MIN.) = 7.72
TOTAL AREA(ACRES) = 8.9
LONGEST FLOWPATH FROM NODE 1009.00 TO NODE 1005.00 = 1518.70 FEET.

*****
FLOW PROCESS FROM NODE 1005.00 TO NODE 1035.00 IS CODE = 31
-----

```

1000P100.RES

```

>>>>COMPUTE PIPE-FLOW TRAVEL TIME THRU SUBAREA<<<<
>>>>USING COMPUTER-ESTIMATED PIPESIZE (NON-PRESSURE FLOW)<<<<
=====
ELEVATION DATA: UPSTREAM(FEET) = 103.37 DOWNSTREAM(FEET) = 101.31
FLOW LENGTH(FEET) = 205.50 MANNING'S N = 0.013
DEPTH OF FLOW IN 27.0 INCH PIPE IS 20.1 INCHES
PIPE-FLOW VELOCITY(FEET/SEC.) = 8.61
ESTIMATED PIPE DIAMETER(INCH) = 27.00 NUMBER OF PIPES = 1
PIPE-FLOW(CFS) = 27.29
PIPE TRAVEL TIME(MIN.) = 0.40 Tc(MIN.) = 8.11
LONGEST FLOWPATH FROM NODE 1009.00 TO NODE 1035.00 = 1724.20 FEET.

*****
FLOW PROCESS FROM NODE 1041.00 TO NODE 1035.00 IS CODE = 81
-----
>>>>ADDITION OF SUBAREA TO MAINLINE PEAK FLOW<<<<
=====
100 YEAR RAINFALL INTENSITY(INCH/HOUR) = 4.627
*USER SPECIFIED(SUBAREA):
USER-SPECIFIED RUNOFF COEFFICIENT = .6500
AREA-AVERAGE RUNOFF COEFFICIENT = 0.6659
SUBAREA AREA(ACRES) = 0.42 SUBAREA RUNOFF(CFS) = 1.26
TOTAL AREA(ACRES) = 9.4 TOTAL RUNOFF(CFS) = 28.87
TC(MIN.) = 8.11

*****
FLOW PROCESS FROM NODE 1035.00 TO NODE 1038.00 IS CODE = 31
-----
>>>>COMPUTE PIPE-FLOW TRAVEL TIME THRU SUBAREA<<<<
>>>>USING COMPUTER-ESTIMATED PIPESIZE (NON-PRESSURE FLOW)<<<<
=====
ELEVATION DATA: UPSTREAM(FEET) = 101.21 DOWNSTREAM(FEET) = 100.70
FLOW LENGTH(FEET) = 32.00 MANNING'S N = 0.013
DEPTH OF FLOW IN 27.0 INCH PIPE IS 17.6 INCHES
PIPE-FLOW VELOCITY(FEET/SEC.) = 10.54
ESTIMATED PIPE DIAMETER(INCH) = 27.00 NUMBER OF PIPES = 1
PIPE-FLOW(CFS) = 28.87
PIPE TRAVEL TIME(MIN.) = 0.05 Tc(MIN.) = 8.16
LONGEST FLOWPATH FROM NODE 1009.00 TO NODE 1038.00 = 1756.20 FEET.

*****
FLOW PROCESS FROM NODE 1035.00 TO NODE 1038.00 IS CODE = 1
-----
>>>>DESIGNATE INDEPENDENT STREAM FOR CONFLUENCE<<<<
=====
TOTAL NUMBER OF STREAMS = 2
CONFLUENCE VALUES USED FOR INDEPENDENT STREAM 1 ARE:
TIME OF CONCENTRATION(MIN.) = 8.16
RAINFALL INTENSITY(INCH/HR) = 4.61
TOTAL STREAM AREA(ACRES) = 9.37
PEAK FLOW RATE(CFS) AT CONFLUENCE = 28.87

*****
FLOW PROCESS FROM NODE 1006.00 TO NODE 1007.00 IS CODE = 21
-----
>>>>RATIONAL METHOD INITIAL SUBAREA ANALYSIS<<<<
=====
*USER SPECIFIED(SUBAREA):
USER-SPECIFIED RUNOFF COEFFICIENT = .6500
INITIAL SUBAREA FLOW-LENGTH(FEET) = 142.80
UPSTREAM ELEVATION(FEET) = 113.10
DOWNSTREAM ELEVATION(FEET) = 111.00
ELEVATION DIFFERENCE(FEET) = 2.10

```

1000P100.RES

URBAN SUBAREA OVERLAND TIME OF FLOW(MIN.) = 6.157  
 WARNING: INITIAL SUBAREA FLOW PATH LENGTH IS GREATER THAN  
 THE MAXIMUM OVERLAND FLOW LENGTH = 74.71  
 (Reference: Table 3-1B of Hydrology Manual)  
 THE MAXIMUM OVERLAND FLOW LENGTH IS USED IN Tc CALCULATION!  
 100 YEAR RAINFALL INTENSITY(INCH/HOUR) = 5.529  
 SUBAREA RUNOFF(CFS) = 0.58  
 TOTAL AREA(ACRES) = 0.16 TOTAL RUNOFF(CFS) = 0.58

\*\*\*\*\*  
 FLOW PROCESS FROM NODE 1007.00 TO NODE 1008.00 IS CODE = 62  
 -----

>>>>COMPUTE STREET FLOW TRAVEL TIME THRU SUBAREA<<<<<<  
 >>>>(STREET TABLE SECTION # 1 USED)<<<<<<  
 -----

UPSTREAM ELEVATION(FEET) = 111.00 DOWNSTREAM ELEVATION(FEET) = 109.00  
 STREET LENGTH(FEET) = 580.00 CURB HEIGHT(INCHES) = 6.0  
 STREET HALFWIDTH(FEET) = 14.50

DISTANCE FROM CROWN TO CROSSFALL GRADEBREAK(FEET) = 8.00  
 INSIDE STREET CROSSFALL(DECIMAL) = 0.018  
 OUTSIDE STREET CROSSFALL(DECIMAL) = 0.018

SPECIFIED NUMBER OF HALFSTREETS CARRYING RUNOFF = 1  
 STREET PARKWAY CROSSFALL(DECIMAL) = 0.020  
 Manning's FRICTION FACTOR for Streetflow Section(curbs-to-curbs) = 0.0150  
 Manning's FRICTION FACTOR for Back-of-Walk Flow Section = 0.0200

\*\*TRAVEL TIME COMPUTED USING ESTIMATED FLOW(CFS) = 2.14  
 STREETFLOW MODEL RESULTS USING ESTIMATED FLOW:  
 STREET FLOW DEPTH(FEET) = 0.35  
 HALFSTREET FLOOD WIDTH(FEET) = 12.59  
 AVERAGE FLOW VELOCITY(FEET/SEC.) = 1.40  
 PRODUCT OF DEPTH&VELOCITY(FT\*FT/SEC.) = 0.49  
 STREET FLOW TRAVEL TIME(MIN.) = 6.93 Tc(MIN.) = 13.08  
 100 YEAR RAINFALL INTENSITY(INCH/HOUR) = 3.400

\*USER SPECIFIED(SUBAREA):  
 USER-SPECIFIED RUNOFF COEFFICIENT = .6500  
 AREA-AVERAGE RUNOFF COEFFICIENT = 0.650  
 SUBAREA AREA(ACRES) = 1.38 SUBAREA RUNOFF(CFS) = 3.05  
 TOTAL AREA(ACRES) = 1.5 PEAK FLOW RATE(CFS) = 3.40

END OF SUBAREA STREET FLOW HYDRAULICS:  
 DEPTH(FEET) = 0.39 HALFSTREET FLOOD WIDTH(FEET) = 14.50  
 FLOW VELOCITY(FEET/SEC.) = 1.52 DEPTH\*VELOCITY(FT\*FT/SEC.) = 0.59  
 LONGEST FLOWPATH FROM NODE 1006.00 TO NODE 1008.00 = 722.80 FEET.

\*\*\*\*\*  
 FLOW PROCESS FROM NODE 1008.00 TO NODE 1038.00 IS CODE = 31  
 -----

>>>>COMPUTE PIPE-FLOW TRAVEL TIME THRU SUBAREA<<<<<<  
 >>>>USING COMPUTER-ESTIMATED PIPESIZE (NON-PRESSURE FLOW)<<<<<<  
 -----

ELEVATION DATA: UPSTREAM(FEET) = 100.91 DOWNSTREAM(FEET) = 100.70  
 FLOW LENGTH(FEET) = 21.14 MANNING'S N = 0.013  
 DEPTH OF FLOW IN 12.0 INCH PIPE IS 9.7 INCHES  
 PIPE-FLOW VELOCITY(FEET/SEC.) = 5.02  
 ESTIMATED PIPE DIAMETER(INCH) = 12.00 NUMBER OF PIPES = 1  
 PIPE-FLOW(CFS) = 3.40  
 PIPE TRAVEL TIME(MIN.) = 0.07 Tc(MIN.) = 13.15  
 LONGEST FLOWPATH FROM NODE 1006.00 TO NODE 1038.00 = 743.94 FEET.

\*\*\*\*\*

1000P100.RES

FLOW PROCESS FROM NODE 1008.00 TO NODE 1038.00 IS CODE = 1  
 -----

>>>>DESIGNATE INDEPENDENT STREAM FOR CONFLUENCE<<<<<<  
 >>>>AND COMPUTE VARIOUS CONFLUENCED STREAM VALUES<<<<<<  
 -----

TOTAL NUMBER OF STREAMS = 2  
 CONFLUENCE VALUES USED FOR INDEPENDENT STREAM 2 ARE:  
 TIME OF CONCENTRATION(MIN.) = 13.15  
 RAINFALL INTENSITY(INCH/HR) = 3.39  
 TOTAL STREAM AREA(ACRES) = 1.54  
 PEAK FLOW RATE(CFS) AT CONFLUENCE = 3.40

\*\* CONFLUENCE DATA \*\*

STREAM NUMBER	RUNOFF (CFS)	Tc (MIN.)	INTENSITY (INCH/HOUR)	AREA (ACRE)
1	28.87	8.16	4.609	9.37
2	3.40	13.15	3.389	1.54

RAINFALL INTENSITY AND TIME OF CONCENTRATION RATIO  
 CONFLUENCE FORMULA USED FOR 2 STREAMS.

\*\* PEAK FLOW RATE TABLE \*\*

STREAM NUMBER	RUNOFF (CFS)	Tc (MIN.)	INTENSITY (INCH/HOUR)
1	30.98	8.16	4.609
2	24.63	13.15	3.389

COMPUTED CONFLUENCE ESTIMATES ARE AS FOLLOWS:

PEAK FLOW RATE(CFS) = 30.98 Tc(MIN.) = 8.16  
 TOTAL AREA(ACRES) = 10.9  
 LONGEST FLOWPATH FROM NODE 1009.00 TO NODE 1038.00 = 1756.20 FEET.  
 -----

END OF STUDY SUMMARY:  
 TOTAL AREA(ACRES) = 10.9 TC(MIN.) = 8.16  
 PEAK FLOW RATE(CFS) = 30.98  
 -----

END OF RATIONAL METHOD ANALYSIS

□



RATIONAL METHOD HYDROGRAPH PROGRAM  
COPYRIGHT 1992, 2001 RICK ENGINEERING COMPANY

RUN DATE 6/14/2022  
HYDROGRAPH FILE NAME System 1000  
TIME OF CONCENTRATION 8 MIN.  
6 HOUR RAINFALL 2.4 INCHES  
BASIN AREA 10.9 ACRES  
RUNOFF COEFFICIENT 0.66  
PEAK DISCHARGE 31 CFS

TIME (MIN) = 0	DISCHARGE (CFS) = 0
TIME (MIN) = 8	DISCHARGE (CFS) = 1
TIME (MIN) = 16	DISCHARGE (CFS) = 1
TIME (MIN) = 24	DISCHARGE (CFS) = 1.1
TIME (MIN) = 32	DISCHARGE (CFS) = 1.1
TIME (MIN) = 40	DISCHARGE (CFS) = 1.1
TIME (MIN) = 48	DISCHARGE (CFS) = 1.2
TIME (MIN) = 56	DISCHARGE (CFS) = 1.2
TIME (MIN) = 64	DISCHARGE (CFS) = 1.2
TIME (MIN) = 72	DISCHARGE (CFS) = 1.3
TIME (MIN) = 80	DISCHARGE (CFS) = 1.3
TIME (MIN) = 88	DISCHARGE (CFS) = 1.3
TIME (MIN) = 96	DISCHARGE (CFS) = 1.4
TIME (MIN) = 104	DISCHARGE (CFS) = 1.4
TIME (MIN) = 112	DISCHARGE (CFS) = 1.5
TIME (MIN) = 120	DISCHARGE (CFS) = 1.6
TIME (MIN) = 128	DISCHARGE (CFS) = 1.6
TIME (MIN) = 136	DISCHARGE (CFS) = 1.7
TIME (MIN) = 144	DISCHARGE (CFS) = 1.8
TIME (MIN) = 152	DISCHARGE (CFS) = 1.9
TIME (MIN) = 160	DISCHARGE (CFS) = 2
TIME (MIN) = 168	DISCHARGE (CFS) = 2.1
TIME (MIN) = 176	DISCHARGE (CFS) = 2.2
TIME (MIN) = 184	DISCHARGE (CFS) = 2.5
TIME (MIN) = 192	DISCHARGE (CFS) = 2.6
TIME (MIN) = 200	DISCHARGE (CFS) = 3
TIME (MIN) = 208	DISCHARGE (CFS) = 3.3
TIME (MIN) = 216	DISCHARGE (CFS) = 4
TIME (MIN) = 224	DISCHARGE (CFS) = 4.5
TIME (MIN) = 232	DISCHARGE (CFS) = 6.7
TIME (MIN) = 240	DISCHARGE (CFS) = 12
TIME (MIN) = 248	DISCHARGE (CFS) = 31
TIME (MIN) = 256	DISCHARGE (CFS) = 5.3
TIME (MIN) = 264	DISCHARGE (CFS) = 3.6
TIME (MIN) = 272	DISCHARGE (CFS) = 2.8
TIME (MIN) = 280	DISCHARGE (CFS) = 2.3
TIME (MIN) = 288	DISCHARGE (CFS) = 2
TIME (MIN) = 296	DISCHARGE (CFS) = 1.8

TIME (MIN) = 304	DISCHARGE (CFS) = 1.6
TIME (MIN) = 312	DISCHARGE (CFS) = 1.5
TIME (MIN) = 320	DISCHARGE (CFS) = 1.4
TIME (MIN) = 328	DISCHARGE (CFS) = 1.3
TIME (MIN) = 336	DISCHARGE (CFS) = 1.2
TIME (MIN) = 344	DISCHARGE (CFS) = 1.2
TIME (MIN) = 352	DISCHARGE (CFS) = 1.1
TIME (MIN) = 360	DISCHARGE (CFS) = 1.1
TIME (MIN) = 368	DISCHARGE (CFS) = 0 ▲

1100P100.RES

1100P100.RES

\*\*\*\*\*

RATIONAL METHOD HYDROLOGY COMPUTER PROGRAM PACKAGE  
 Reference: SAN DIEGO COUNTY FLOOD CONTROL DISTRICT  
 2003,1985,1981 HYDROLOGY MANUAL  
 (c) Copyright 1982-2016 Advanced Engineering Software (aes)  
 Ver. 23.0 Release Date: 07/01/2016 License ID 1509

Analysis prepared by:

\*\*\*\*\* DESCRIPTION OF STUDY \*\*\*\*\*  
 \* NAKANO - PROPOSED CONDITION 4409 \*  
 \* SYSTEM 1100 (INCLUDING SYS1000) \*  
 \* 100 YEAR STORM EVENT \*  
 \*\*\*\*\*

FILE NAME: 1100P100.DAT  
 TIME/DATE OF STUDY: 11:22 06/14/2022

-----  
 USER SPECIFIED HYDROLOGY AND HYDRAULIC MODEL INFORMATION:  
 -----

2003 SAN DIEGO MANUAL CRITERIA

USER SPECIFIED STORM EVENT(YEAR) = 100.00  
 6-HOUR DURATION PRECIPITATION (INCHES) = 2.400  
 SPECIFIED MINIMUM PIPE SIZE(INCH) = 12.00  
 SPECIFIED PERCENT OF GRADIENTS(DECIMAL) TO USE FOR FRICTION SLOPE = 0.95  
 SAN DIEGO HYDROLOGY MANUAL "C"-VALUES USED FOR RATIONAL METHOD  
 \*CITY OF CHULA VISTA TIME-OF-CONCENTRATION MODEL SELECTED.\*  
 (BASED ON 07/2002 ADOPTED MANUAL)

NOTE: USE MODIFIED RATIONAL METHOD PROCEDURES FOR CONFLUENCE ANALYSIS  
 \*USER-DEFINED STREET-SECTIONS FOR COUPLED PIPEFLOW AND STREETFLOW MODEL\*

NO.	HALF- WIDTH (FT)	CROWN TO CROSSFALL (FT)	STREET-CROSSFALL: IN- / OUT-/ SIDE / SIDE/ WAY	CURB HEIGHT (FT)	GUTTER-GEOMETRIES: HEIGHT (FT)	MANNING LIP (FT)	HIKE (FT)	FACTOR (n)
1	14.5	8.0	0.018/0.018/0.020	0.50	1.50	0.0313	0.125	0.0150

GLOBAL STREET FLOW-DEPTH CONSTRAINTS:  
 1. Relative Flow-Depth = 0.00 FEET  
 as (Maximum Allowable Street Flow Depth) - (Top-of-Curb)  
 2. (Depth)\*(Velocity) Constraint = 6.0 (FT\*FT/S)  
 \*SIZE PIPE WITH A FLOW CAPACITY GREATER THAN  
 OR EQUAL TO THE UPSTREAM TRIBUTARY PIPE.\*

\*\*\*\*\*  
 FLOW PROCESS FROM NODE 1100.00 TO NODE 1101.00 IS CODE = 21  
 -----

>>>>RATIONAL METHOD INITIAL SUBAREA ANALYSIS<<<<  
 -----

\*USER SPECIFIED(SUBAREA):  
 USER-SPECIFIED RUNOFF COEFFICIENT = .6500  
 INITIAL SUBAREA FLOW-LENGTH(FEET) = 143.00  
 UPSTREAM ELEVATION(FEET) = 116.80  
 DOWNSTREAM ELEVATION(FEET) = 115.00  
 ELEVATION DIFFERENCE(FEET) = 1.80  
 URBAN SUBAREA OVERLAND TIME OF FLOW(MIN.) = 6.392

WARNING: INITIAL SUBAREA FLOW PATH LENGTH IS GREATER THAN  
 THE MAXIMUM OVERLAND FLOW LENGTH = 72.59  
 (Reference: Table 3-1B of Hydrology Manual)  
 THE MAXIMUM OVERLAND FLOW LENGTH IS USED IN Tc CALCULATION!  
 100 YEAR RAINFALL INTENSITY(INCH/HOUR) = 5.397  
 SUBAREA RUNOFF(CFS) = 0.63  
 TOTAL AREA(ACRES) = 0.18 TOTAL RUNOFF(CFS) = 0.63

\*\*\*\*\*  
 FLOW PROCESS FROM NODE 1101.00 TO NODE 1102.00 IS CODE = 62  
 -----

>>>>COMPUTE STREET FLOW TRAVEL TIME THRU SUBAREA<<<<  
 >>>>(STREET TABLE SECTION # 1 USED)<<<<  
 -----

UPSTREAM ELEVATION(FEET) = 115.50 DOWNSTREAM ELEVATION(FEET) = 111.10  
 STREET LENGTH(FEET) = 398.00 CURB HEIGHT(INCHES) = 6.0  
 STREET HALFWIDTH(FEET) = 14.50

DISTANCE FROM CROWN TO CROSSFALL GRADEBREAK(FEET) = 8.00  
 INSIDE STREET CROSSFALL(DECIMAL) = 0.018  
 OUTSIDE STREET CROSSFALL(DECIMAL) = 0.018

SPECIFIED NUMBER OF HALFSTREETS CARRYING RUNOFF = 1  
 STREET PARKWAY CROSSFALL(DECIMAL) = 0.020  
 Manning's FRICTION FACTOR for Streetflow Section(curbs-to-curbs) = 0.0150  
 Manning's FRICTION FACTOR for Back-of-Walk Flow Section = 0.0200

\*\*TRAVEL TIME COMPUTED USING ESTIMATED FLOW(CFS) = 2.35  
 STREETFLOW MODEL RESULTS USING ESTIMATED FLOW:  
 STREET FLOW DEPTH(FEET) = 0.31  
 HALFSTREET FLOOD WIDTH(FEET) = 10.22  
 AVERAGE FLOW VELOCITY(FEET/SEC.) = 2.23  
 PRODUCT OF DEPTH&VELOCITY(FT\*FT/SEC.) = 0.69  
 STREET FLOW TRAVEL TIME(MIN.) = 2.98 Tc(MIN.) = 9.37  
 100 YEAR RAINFALL INTENSITY(INCH/HOUR) = 4.217  
 \*USER SPECIFIED(SUBAREA):  
 USER-SPECIFIED RUNOFF COEFFICIENT = .6500  
 AREA-AVERAGE RUNOFF COEFFICIENT = 0.650  
 SUBAREA AREA(ACRES) = 1.24 SUBAREA RUNOFF(CFS) = 3.40  
 TOTAL AREA(ACRES) = 1.4 PEAK FLOW RATE(CFS) = 3.89

END OF SUBAREA STREET FLOW HYDRAULICS:  
 DEPTH(FEET) = 0.36 HALFSTREET FLOOD WIDTH(FEET) = 12.66  
 FLOW VELOCITY(FEET/SEC.) = 2.51 DEPTH\*VELOCITY(FT\*FT/SEC.) = 0.89  
 LONGEST FLOWPATH FROM NODE 1100.00 TO NODE 1102.00 = 541.00 FEET.

\*\*\*\*\*  
 FLOW PROCESS FROM NODE 1102.00 TO NODE 1103.00 IS CODE = 31  
 -----

>>>>COMPUTE PIPE-FLOW TRAVEL TIME THRU SUBAREA<<<<  
 >>>>USING COMPUTER-ESTIMATED PIPESIZE (NON-PRESSURE FLOW)<<<<  
 -----

ELEVATION DATA: UPSTREAM(FEET) = 109.00 DOWNSTREAM(FEET) = 108.70  
 FLOW LENGTH(FEET) = 22.60 MANNING'S N = 0.013  
 DEPTH OF FLOW IN 12.0 INCH PIPE IS 9.5 INCHES  
 PIPE-FLOW VELOCITY(FEET/SEC.) = 5.81  
 ESTIMATED PIPE DIAMETER(INCH) = 12.00 NUMBER OF PIPES = 1  
 PIPE-FLOW(CFS) = 3.89  
 PIPE TRAVEL TIME(MIN.) = 0.06 Tc(MIN.) = 9.43  
 LONGEST FLOWPATH FROM NODE 1100.00 TO NODE 1103.00 = 563.60 FEET.

\*\*\*\*\*  
 FLOW PROCESS FROM NODE 1104.00 TO NODE 1103.00 IS CODE = 81  
 -----

## 1100P100.RES

## 1100P100.RES

```

-----
>>>>ADDITION OF SUBAREA TO MAINLINE PEAK FLOW<<<<
-----
100 YEAR RAINFALL INTENSITY(INCH/HOUR) = 4.199
*USER SPECIFIED(SUBAREA):
USER-SPECIFIED RUNOFF COEFFICIENT = .6500
AREA-AVERAGE RUNOFF COEFFICIENT = 0.6500
SUBAREA AREA(ACRES) = 1.05 SUBAREA RUNOFF(CFS) = 2.87
TOTAL AREA(ACRES) = 2.5 TOTAL RUNOFF(CFS) = 6.74
TC(MIN.) = 9.43
*****
FLOW PROCESS FROM NODE 1103.00 TO NODE 1105.00 IS CODE = 31
-----
>>>>COMPUTE PIPE-FLOW TRAVEL TIME THRU SUBAREA<<<<
>>>>USING COMPUTER-ESTIMATED PIPESIZE (NON-PRESSURE FLOW)<<<<
-----
ELEVATION DATA: UPSTREAM(FEET) = 109.00 DOWNSTREAM(FEET) = 107.70
FLOW LENGTH(FEET) = 229.70 MANNING'S N = 0.013
DEPTH OF FLOW IN 18.0 INCH PIPE IS 13.0 INCHES
PIPE-FLOW VELOCITY(FEET/SEC.) = 4.92
ESTIMATED PIPE DIAMETER(INCH) = 18.00 NUMBER OF PIPES = 1
PIPE-FLOW(CFS) = 6.74
PIPE TRAVEL TIME(MIN.) = 0.78 Tc(MIN.) = 10.21
LONGEST FLOWPATH FROM NODE 1100.00 TO NODE 1105.00 = 793.30 FEET.
*****
FLOW PROCESS FROM NODE 1106.00 TO NODE 1105.00 IS CODE = 81
-----
>>>>ADDITION OF SUBAREA TO MAINLINE PEAK FLOW<<<<
-----
100 YEAR RAINFALL INTENSITY(INCH/HOUR) = 3.989
*USER SPECIFIED(SUBAREA):
USER-SPECIFIED RUNOFF COEFFICIENT = .6500
AREA-AVERAGE RUNOFF COEFFICIENT = 0.6500
SUBAREA AREA(ACRES) = 0.45 SUBAREA RUNOFF(CFS) = 1.17
TOTAL AREA(ACRES) = 2.9 TOTAL RUNOFF(CFS) = 7.57
TC(MIN.) = 10.21
*****
FLOW PROCESS FROM NODE 1105.00 TO NODE 1107.00 IS CODE = 31
-----
>>>>COMPUTE PIPE-FLOW TRAVEL TIME THRU SUBAREA<<<<
>>>>USING COMPUTER-ESTIMATED PIPESIZE (NON-PRESSURE FLOW)<<<<
-----
ELEVATION DATA: UPSTREAM(FEET) = 107.70 DOWNSTREAM(FEET) = 100.90
FLOW LENGTH(FEET) = 230.00 MANNING'S N = 0.013
DEPTH OF FLOW IN 15.0 INCH PIPE IS 9.2 INCHES
PIPE-FLOW VELOCITY(FEET/SEC.) = 9.54
ESTIMATED PIPE DIAMETER(INCH) = 15.00 NUMBER OF PIPES = 1
PIPE-FLOW(CFS) = 7.57
PIPE TRAVEL TIME(MIN.) = 0.40 Tc(MIN.) = 10.61
LONGEST FLOWPATH FROM NODE 1100.00 TO NODE 1107.00 = 1023.30 FEET.
*****
FLOW PROCESS FROM NODE 1005.00 TO NODE 1007.00 IS CODE = 1
-----
>>>>DESIGNATE INDEPENDENT STREAM FOR CONFLUENCE<<<<
-----
TOTAL NUMBER OF STREAMS = 2
CONFLUENCE VALUES USED FOR INDEPENDENT STREAM 1 ARE:
TIME OF CONCENTRATION(MIN.) = 10.61
RAINFALL INTENSITY(INCH/HR) = 3.89

```

```

TOTAL STREAM AREA(ACRES) = 2.92
PEAK FLOW RATE(CFS) AT CONFLUENCE = 7.57

```

```

*****
FLOW PROCESS FROM NODE 1108.00 TO NODE 1109.00 IS CODE = 21
-----
>>>>RATIONAL METHOD INITIAL SUBAREA ANALYSIS<<<<
-----
*USER SPECIFIED(SUBAREA):
USER-SPECIFIED RUNOFF COEFFICIENT = .6500
INITIAL SUBAREA FLOW-LENGTH(FEET) = 138.00
UPSTREAM ELEVATION(FEET) = 112.50
DOWNSTREAM ELEVATION(FEET) = 111.00
ELEVATION DIFFERENCE(FEET) = 1.50
URBAN SUBAREA OVERLAND TIME OF FLOW(MIN.) = 6.632
WARNING: INITIAL SUBAREA FLOW PATH LENGTH IS GREATER THAN
THE MAXIMUM OVERLAND FLOW LENGTH = 70.87
(Reference: Table 3-1B of Hydrology Manual)
THE MAXIMUM OVERLAND FLOW LENGTH IS USED IN Tc CALCULATION!
100 YEAR RAINFALL INTENSITY(INCH/HOUR) = 5.270
SUBAREA RUNOFF(CFS) = 0.55
TOTAL AREA(ACRES) = 0.16 TOTAL RUNOFF(CFS) = 0.55
*****
FLOW PROCESS FROM NODE 1109.00 TO NODE 1107.00 IS CODE = 62
-----
>>>>COMPUTE STREET FLOW TRAVEL TIME THRU SUBAREA<<<<
>>>>(STREET TABLE SECTION # 1 USED)<<<<
-----
UPSTREAM ELEVATION(FEET) = 111.00 DOWNSTREAM ELEVATION(FEET) = 109.00
STREET LENGTH(FEET) = 191.00 CURB HEIGHT(INCHES) = 6.0
STREET HALFWIDTH(FEET) = 14.50
DISTANCE FROM CROWN TO CROSSFALL GRADEBREAK(FEET) = 8.00
INSIDE STREET CROSSFALL(DECIMAL) = 0.018
OUTSIDE STREET CROSSFALL(DECIMAL) = 0.018
SPECIFIED NUMBER OF HALFSTREETS CARRYING RUNOFF = 2
STREET PARKWAY CROSSFALL(DECIMAL) = 0.020
Manning's FRICTION FACTOR for Streetflow Section(curbs-to-curbs) = 0.0150
Manning's FRICTION FACTOR for Back-of-Walk Flow Section = 0.0200
**TRAVEL TIME COMPUTED USING ESTIMATED FLOW(CFS) = 2.92
STREETFLOW MODEL RESULTS USING ESTIMATED FLOW:
STREET FLOW DEPTH(FEET) = 0.28
HALFSTREET FLOOD WIDTH(FEET) = 8.34
AVERAGE FLOW VELOCITY(FEET/SEC.) = 1.97
PRODUCT OF DEPTH&VELOCITY(FT*FT/SEC.) = 0.55
STREET FLOW TRAVEL TIME(MIN.) = 1.62 Tc(MIN.) = 8.25
100 YEAR RAINFALL INTENSITY(INCH/HOUR) = 4.578
*USER SPECIFIED(SUBAREA):
USER-SPECIFIED RUNOFF COEFFICIENT = .6500
AREA-AVERAGE RUNOFF COEFFICIENT = 0.6500
SUBAREA AREA(ACRES) = 1.59 SUBAREA RUNOFF(CFS) = 4.73
TOTAL AREA(ACRES) = 1.8 PEAK FLOW RATE(CFS) = 5.21
END OF SUBAREA STREET FLOW HYDRAULICS:
DEPTH(FEET) = 0.32 HALFSTREET FLOOD WIDTH(FEET) = 10.78
FLOW VELOCITY(FEET/SEC.) = 2.25 DEPTH*VELOCITY(FT*FT/SEC.) = 0.72
LONGEST FLOWPATH FROM NODE 1108.00 TO NODE 1107.00 = 329.00 FEET.
*****
FLOW PROCESS FROM NODE 1110.00 TO NODE 1107.00 IS CODE = 81

```

1100P100.RES

1100P100.RES

```

>>>>ADDITION OF SUBAREA TO MAINLINE PEAK FLOW<<<<
=====
 100 YEAR RAINFALL INTENSITY(INCH/HOUR) = 4.578
*USER SPECIFIED(SUBAREA):
USER-SPECIFIED RUNOFF COEFFICIENT = .9000
AREA-AVERAGE RUNOFF COEFFICIENT = 0.7029
SUBAREA AREA(ACRES) = 0.47 SUBAREA RUNOFF(CFS) = 1.94
TOTAL AREA(ACRES) = 2.2 TOTAL RUNOFF(CFS) = 7.14
TC(MIN.) = 8.25

*****
FLOW PROCESS FROM NODE 1111.00 TO NODE 1107.00 IS CODE = 81
-----
>>>>ADDITION OF SUBAREA TO MAINLINE PEAK FLOW<<<<
=====
 100 YEAR RAINFALL INTENSITY(INCH/HOUR) = 4.578
*USER SPECIFIED(SUBAREA):
USER-SPECIFIED RUNOFF COEFFICIENT = .4500
AREA-AVERAGE RUNOFF COEFFICIENT = 0.6820
SUBAREA AREA(ACRES) = 0.20 SUBAREA RUNOFF(CFS) = 0.41
TOTAL AREA(ACRES) = 2.4 TOTAL RUNOFF(CFS) = 7.56
TC(MIN.) = 8.25

*****
FLOW PROCESS FROM NODE 1111.00 TO NODE 1107.00 IS CODE = 1
-----
>>>>DESIGNATE INDEPENDENT STREAM FOR CONFLUENCE<<<<
>>>>AND COMPUTE VARIOUS CONFLUENCED STREAM VALUES<<<<
=====
TOTAL NUMBER OF STREAMS = 2
CONFLUENCE VALUES USED FOR INDEPENDENT STREAM 2 ARE:
TIME OF CONCENTRATION(MIN.) = 8.25
RAINFALL INTENSITY(INCH/HR) = 4.58
TOTAL STREAM AREA(ACRES) = 2.42
PEAK FLOW RATE(CFS) AT CONFLUENCE = 7.56

** CONFLUENCE DATA **
STREAM RUNOFF Tc INTENSITY AREA
NUMBER (CFS) (MIN.) (INCH/HOUR) (ACRE)
1 7.57 10.61 3.891 2.92
2 7.56 8.25 4.578 2.42

RAINFALL INTENSITY AND TIME OF CONCENTRATION RATIO
CONFLUENCE FORMULA USED FOR 2 STREAMS.

** PEAK FLOW RATE TABLE **
STREAM RUNOFF Tc INTENSITY
NUMBER (CFS) (MIN.) (INCH/HOUR)
1 13.44 8.25 4.578
2 13.99 10.61 3.891

COMPUTED CONFLUENCE ESTIMATES ARE AS FOLLOWS:
PEAK FLOW RATE(CFS) = 13.99 Tc(MIN.) = 10.61
TOTAL AREA(ACRES) = 5.3
LONGEST FLOWPATH FROM NODE 1100.00 TO NODE 1107.00 = 1023.30 FEET.

*****
FLOW PROCESS FROM NODE 1107.00 TO NODE 1055.00 IS CODE = 31
-----
>>>>COMPUTE PIPE-FLOW TRAVEL TIME THRU SUBAREA<<<<
>>>>USING COMPUTER-ESTIMATED PIPESIZE (NON-PRESSURE FLOW)<<<<
=====

```

```

ELEVATION DATA: UPSTREAM(FEET) = 105.50 DOWNSTREAM(FEET) = 105.00
FLOW LENGTH(FEET) = 8.00 MANNING'S N = 0.013
DEPTH OF FLOW IN 15.0 INCH PIPE IS 11.0 INCHES
PIPE-FLOW VELOCITY(FEET/SEC.) = 14.49
ESTIMATED PIPE DIAMETER(INCH) = 15.00 NUMBER OF PIPES = 1
PIPE-FLOW(CFS) = 13.99
PIPE TRAVEL TIME(MIN.) = 0.01 Tc(MIN.) = 10.62
LONGEST FLOWPATH FROM NODE 1100.00 TO NODE 1055.00 = 1031.30 FEET.

*****
FLOW PROCESS FROM NODE 1112.00 TO NODE 1055.00 IS CODE = 81
-----
>>>>ADDITION OF SUBAREA TO MAINLINE PEAK FLOW<<<<
=====
 100 YEAR RAINFALL INTENSITY(INCH/HOUR) = 3.889
*USER SPECIFIED(SUBAREA):
USER-SPECIFIED RUNOFF COEFFICIENT = .4500
AREA-AVERAGE RUNOFF COEFFICIENT = 0.6617
SUBAREA AREA(ACRES) = 0.07 SUBAREA RUNOFF(CFS) = 0.12
TOTAL AREA(ACRES) = 5.4 TOTAL RUNOFF(CFS) = 13.99
TC(MIN.) = 10.62
NOTE: PEAK FLOW RATE DEFAULTED TO UPSTREAM VALUE

*****
FLOW PROCESS FROM NODE 1038.00 TO NODE 1055.00 IS CODE = 1
-----
>>>>DESIGNATE INDEPENDENT STREAM FOR CONFLUENCE<<<<
=====
TOTAL NUMBER OF STREAMS = 2
CONFLUENCE VALUES USED FOR INDEPENDENT STREAM 1 ARE:
TIME OF CONCENTRATION(MIN.) = 10.62
RAINFALL INTENSITY(INCH/HR) = 3.89
TOTAL STREAM AREA(ACRES) = 5.41
PEAK FLOW RATE(CFS) AT CONFLUENCE = 13.99

*****
FLOW PROCESS FROM NODE 1038.00 TO NODE 1038.00 IS CODE = 7
-----
>>>>USER SPECIFIED HYDROLOGY INFORMATION AT NODE<<<<
=====
USER-SPECIFIED VALUES ARE AS FOLLOWS:
TC(MIN) = 68.20 RAIN INTENSITY(INCH/HOUR) = 1.17
TOTAL AREA(ACRES) = 10.90 TOTAL RUNOFF(CFS) = 1.55

*****
FLOW PROCESS FROM NODE 1038.00 TO NODE 1055.00 IS CODE = 1
-----
>>>>DESIGNATE INDEPENDENT STREAM FOR CONFLUENCE<<<<
>>>>AND COMPUTE VARIOUS CONFLUENCED STREAM VALUES<<<<
=====
TOTAL NUMBER OF STREAMS = 2
CONFLUENCE VALUES USED FOR INDEPENDENT STREAM 2 ARE:
TIME OF CONCENTRATION(MIN.) = 68.20
RAINFALL INTENSITY(INCH/HR) = 1.17
TOTAL STREAM AREA(ACRES) = 10.90
PEAK FLOW RATE(CFS) AT CONFLUENCE = 1.55

** CONFLUENCE DATA **
STREAM RUNOFF Tc INTENSITY AREA
NUMBER (CFS) (MIN.) (INCH/HOUR) (ACRE)
1 13.99 10.62 3.889 5.41
2 1.55 68.20 1.172 10.90

```

1100P100.RES

RAINFALL INTENSITY AND TIME OF CONCENTRATION RATIO  
CONFLUENCE FORMULA USED FOR 2 STREAMS.

\*\* PEAK FLOW RATE TABLE \*\*

STREAM NUMBER	RUNOFF (CFS)	Tc (MIN.)	INTENSITY (INCH/HOUR)
1	14.24	10.62	3.889
2	5.77	68.20	1.172

COMPUTED CONFLUENCE ESTIMATES ARE AS FOLLOWS:  
PEAK FLOW RATE (CFS) = 14.24 Tc (MIN.) = 10.62  
TOTAL AREA (ACRES) = 16.3  
LONGEST FLOWPATH FROM NODE 1100.00 TO NODE 1055.00 = 1031.30 FEET.

\*\*\*\*\*

FLOW PROCESS FROM NODE 1055.00 TO NODE 1056.00 IS CODE = 31

>>>>COMPUTE PIPE-FLOW TRAVEL TIME THRU SUBAREA<<<<<  
>>>>USING COMPUTER-ESTIMATED PIPESIZE (NON-PRESSURE FLOW)<<<<<

=====

ELEVATION DATA: UPSTREAM (FEET) = 98.28 DOWNSTREAM (FEET) = 98.00  
FLOW LENGTH (FEET) = 28.00 MANNING'S N = 0.013  
DEPTH OF FLOW IN 21.0 INCH PIPE IS 15.9 INCHES  
PIPE-FLOW VELOCITY (FEET/SEC.) = 7.29  
ESTIMATED PIPE DIAMETER (INCH) = 21.00 NUMBER OF PIPES = 1  
PIPE-FLOW (CFS) = 14.24  
PIPE TRAVEL TIME (MIN.) = 0.06 Tc (MIN.) = 10.69  
LONGEST FLOWPATH FROM NODE 1100.00 TO NODE 1056.00 = 1059.30 FEET.

=====

END OF STUDY SUMMARY:  
TOTAL AREA (ACRES) = 16.3 TC (MIN.) = 10.69  
PEAK FLOW RATE (CFS) = 14.24

=====

END OF RATIONAL METHOD ANALYSIS

□

1200P100.RES

\*\*\*\*\*

RATIONAL METHOD HYDROLOGY COMPUTER PROGRAM PACKAGE
Reference: SAN DIEGO COUNTY FLOOD CONTROL DISTRICT
2003,1985,1981 HYDROLOGY MANUAL
(c) Copyright 1982-2016 Advanced Engineering Software (aes)
Ver. 23.0 Release Date: 07/01/2016 License ID 1509

Analysis prepared by:

\*\*\*\*\* DESCRIPTION OF STUDY \*\*\*\*\*
\* NAKANO 4409 \*
\* SYSTEM 1200 \*
\* 100 YEAR STORM EVENT \*
\*\*\*\*\*

FILE NAME: 1200P100.DAT
TIME/DATE OF STUDY: 12:06 06/17/2022

-----
USER SPECIFIED HYDROLOGY AND HYDRAULIC MODEL INFORMATION:
-----

2003 SAN DIEGO MANUAL CRITERIA

USER SPECIFIED STORM EVENT(YEAR) = 100.00
6-HOUR DURATION PRECIPITATION (INCHES) = 2.400
SPECIFIED MINIMUM PIPE SIZE(INCH) = 12.00
SPECIFIED PERCENT OF GRADIENTS(DECIMAL) TO USE FOR FRICTION SLOPE = 0.95
SAN DIEGO HYDROLOGY MANUAL "C"-VALUES USED FOR RATIONAL METHOD
\*CITY OF CHULA VISTA TIME-OF-CONCENTRATION MODEL SELECTED.\*
(BASED ON 07/2002 ADOPTED MANUAL)

NOTE: USE MODIFIED RATIONAL METHOD PROCEDURES FOR CONFLUENCE ANALYSIS
\*USER-DEFINED STREET-SECTIONS FOR COUPLED PIPEFLOW AND STREETFLOW MODEL\*
HALF- CROWN TO STREET-CROSSFALL: CURB GUTTER-GEOMETRIES: MANNING
WIDTH CROSSFALL IN- / OUT-/PARK- HEIGHT WIDTH LIP HIKE FACTOR
NO. (FT) (FT) SIDE / SIDE/ WAY (FT) (FT) (FT) (FT) (n)
=====
1 30.0 20.0 0.018/0.018/0.020 0.50 2.00 0.0313 0.167 0.0150

GLOBAL STREET FLOW-DEPTH CONSTRAINTS:
1. Relative Flow-Depth = 0.00 FEET
as (Maximum Allowable Street Flow Depth) - (Top-of-Curb)
2. (Depth)\*(Velocity) Constraint = 6.0 (FT\*FT/S)
\*SIZE PIPE WITH A FLOW CAPACITY GREATER THAN
OR EQUAL TO THE UPSTREAM TRIBUTARY PIPE.\*

1300P100.RES

1300P100.RES

\*\*\*\*\*

RATIONAL METHOD HYDROLOGY COMPUTER PROGRAM PACKAGE  
 Reference: SAN DIEGO COUNTY FLOOD CONTROL DISTRICT  
 2003,1985,1981 HYDROLOGY MANUAL  
 (c) Copyright 1982-2016 Advanced Engineering Software (aes)  
 Ver. 23.0 Release Date: 07/01/2016 License ID 1509

Analysis prepared by:

\*\*\*\*\* DESCRIPTION OF STUDY \*\*\*\*\*  
 \* NAKANO 4409 \*  
 \* SYSTEM 1300 \*  
 \* 100 YEAR STORM EVENT \*  
 \*\*\*\*\*

FILE NAME: 1300P100.DAT  
 TIME/DATE OF STUDY: 12:05 06/17/2022

-----  
 USER SPECIFIED HYDROLOGY AND HYDRAULIC MODEL INFORMATION:  
 -----

2003 SAN DIEGO MANUAL CRITERIA

USER SPECIFIED STORM EVENT(YEAR) = 100.00  
 6-HOUR DURATION PRECIPITATION (INCHES) = 2.400  
 SPECIFIED MINIMUM PIPE SIZE(INCH) = 12.00  
 SPECIFIED PERCENT OF GRADIENTS(DECIMAL) TO USE FOR FRICTION SLOPE = 0.95  
 SAN DIEGO HYDROLOGY MANUAL "C"-VALUES USED FOR RATIONAL METHOD  
 \*CITY OF CHULA VISTA TIME-OF-CONCENTRATION MODEL SELECTED.\*  
 (BASED ON 07/2002 ADOPTED MANUAL)

NOTE: USE MODIFIED RATIONAL METHOD PROCEDURES FOR CONFLUENCE ANALYSIS

\*USER-DEFINED STREET-SECTIONS FOR COUPLED PIPEFLOW AND STREETFLOW MODEL\*

NO.	WIDTH (FT)	CROSSFALL (FT)	IN- / SIDE	OUT- / SIDE/ WAY	HEIGHT (FT)	WIDTH (FT)	LIP (FT)	HIKE (FT)	FACTOR (n)
1	30.0	20.0	0.018/0.018	0.020	0.67	2.00	0.0313	0.167	0.0150

GLOBAL STREET FLOW-DEPTH CONSTRAINTS:

- Relative Flow-Depth = 0.00 FEET  
 as (Maximum Allowable Street Flow Depth) - (Top-of-Curb)
  - (Depth)\*(Velocity) Constraint = 6.0 (FT\*FT/S)
- \*SIZE PIPE WITH A FLOW CAPACITY GREATER THAN  
 OR EQUAL TO THE UPSTREAM TRIBUTARY PIPE.\*

\*\*\*\*\*  
 FLOW PROCESS FROM NODE 1300.00 TO NODE 1301.00 IS CODE = 22  
 -----

>>>>RATIONAL METHOD INITIAL SUBAREA ANALYSIS<<<<

\*\*\*\*\*  
 \*USER SPECIFIED(SUBAREA):  
 USER-SPECIFIED RUNOFF COEFFICIENT = .6000  
 USER SPECIFIED Tc(MIN.) = 5.000  
 100 YEAR RAINFALL INTENSITY(INCH/HOUR) = 6.323  
 SUBAREA RUNOFF(CFS) = 0.11  
 TOTAL AREA(ACRES) = 0.03 TOTAL RUNOFF(CFS) = 0.11  
 -----

\*\*\*\*\*  
 FLOW PROCESS FROM NODE 1301.00 TO NODE 1302.00 IS CODE = 51  
 -----

>>>>COMPUTE TRAPEZOIDAL CHANNEL FLOW<<<<  
 >>>>TRAVELTIME THRU SUBAREA (EXISTING ELEMENT)<<<<

\*\*\*\*\*  
 ELEVATION DATA: UPSTREAM(FEET) = 186.00 DOWNSTREAM(FEET) = 113.00  
 CHANNEL LENGTH THRU SUBAREA(FEET) = 717.00 CHANNEL SLOPE = 0.1018  
 CHANNEL BASE(FEET) = 10.00 "Z" FACTOR = 2.000  
 MANNING'S FACTOR = 0.030 MAXIMUM DEPTH(FEET) = 2.00  
 100 YEAR RAINFALL INTENSITY(INCH/HOUR) = 4.322  
 \*USER SPECIFIED(SUBAREA):  
 USER-SPECIFIED RUNOFF COEFFICIENT = .6000  
 TRAVEL TIME COMPUTED USING ESTIMATED FLOW(CFS) = 2.45  
 TRAVEL TIME THRU SUBAREA BASED ON VELOCITY(FEET/SEC.) = 2.97  
 AVERAGE FLOW DEPTH(FEET) = 0.08 TRAVEL TIME(MIN.) = 4.02  
 Tc(MIN.) = 9.02  
 SUBAREA AREA(ACRES) = 1.75 SUBAREA RUNOFF(CFS) = 4.54  
 AREA-AVERAGE RUNOFF COEFFICIENT = 0.600  
 TOTAL AREA(ACRES) = 1.8 PEAK FLOW RATE(CFS) = 4.62  
 -----

END OF SUBAREA CHANNEL FLOW HYDRAULICS:  
 DEPTH(FEET) = 0.12 FLOW VELOCITY(FEET/SEC.) = 3.78  
 LONGEST FLOWPATH FROM NODE 1300.00 TO NODE 1302.00 = 717.00 FEET.

\*\*\*\*\*  
 FLOW PROCESS FROM NODE 1302.00 TO NODE 1303.00 IS CODE = 31  
 -----

>>>>COMPUTE PIPE-FLOW TRAVEL TIME THRU SUBAREA<<<<  
 >>>>USING COMPUTER-ESTIMATED PIPESIZE (NON-PRESSURE FLOW)<<<<

\*\*\*\*\*  
 ELEVATION DATA: UPSTREAM(FEET) = 112.00 DOWNSTREAM(FEET) = 111.50  
 FLOW LENGTH(FEET) = 24.60 MANNING'S N = 0.013  
 DEPTH OF FLOW IN 12.0 INCH PIPE IS 9.2 INCHES  
 PIPE-FLOW VELOCITY(FEET/SEC.) = 7.17  
 ESTIMATED PIPE DIAMETER(INCH) = 12.00 NUMBER OF PIPES = 1  
 PIPE-FLOW(CFS) = 4.62  
 PIPE TRAVEL TIME(MIN.) = 0.06 Tc(MIN.) = 9.08  
 LONGEST FLOWPATH FROM NODE 1300.00 TO NODE 1303.00 = 741.60 FEET.  
 -----

\*\*\*\*\*  
 FLOW PROCESS FROM NODE 1303.00 TO NODE 1304.00 IS CODE = 51  
 -----

>>>>COMPUTE TRAPEZOIDAL CHANNEL FLOW<<<<  
 >>>>TRAVELTIME THRU SUBAREA (EXISTING ELEMENT)<<<<

\*\*\*\*\*  
 ELEVATION DATA: UPSTREAM(FEET) = 111.50 DOWNSTREAM(FEET) = 106.00  
 CHANNEL LENGTH THRU SUBAREA(FEET) = 345.00 CHANNEL SLOPE = 0.0159  
 CHANNEL BASE(FEET) = 5.00 "Z" FACTOR = 2.500  
 MANNING'S FACTOR = 0.013 MAXIMUM DEPTH(FEET) = 2.00  
 100 YEAR RAINFALL INTENSITY(INCH/HOUR) = 3.972  
 \*USER SPECIFIED(SUBAREA):  
 USER-SPECIFIED RUNOFF COEFFICIENT = .6000  
 TRAVEL TIME COMPUTED USING ESTIMATED FLOW(CFS) = 5.73  
 TRAVEL TIME THRU SUBAREA BASED ON VELOCITY(FEET/SEC.) = 4.77  
 AVERAGE FLOW DEPTH(FEET) = 0.22 TRAVEL TIME(MIN.) = 1.20  
 Tc(MIN.) = 10.28  
 SUBAREA AREA(ACRES) = 0.93 SUBAREA RUNOFF(CFS) = 2.22  
 AREA-AVERAGE RUNOFF COEFFICIENT = 0.600  
 TOTAL AREA(ACRES) = 2.7 PEAK FLOW RATE(CFS) = 6.46  
 -----

END OF SUBAREA CHANNEL FLOW HYDRAULICS:  
 DEPTH(FEET) = 0.23 FLOW VELOCITY(FEET/SEC.) = 5.00



1300P100.RES

LONGEST FLOWPATH FROM NODE 1300.00 TO NODE 1304.00 = 1086.60 FEET.

\*\*\*\*\*  
FLOW PROCESS FROM NODE 1304.00 TO NODE 1306.00 IS CODE = 31

-----  
>>>>COMPUTE PIPE-FLOW TRAVEL TIME THRU SUBAREA<<<<<  
>>>>USING COMPUTER-ESTIMATED PIPESIZE (NON-PRESSURE FLOW)<<<<<

=====

ELEVATION DATA: UPSTREAM(FEET) =	106.00	DOWNSTREAM(FEET) =	104.00
FLOW LENGTH(FEET) =	90.00	MANNING'S N =	0.013
DEPTH OF FLOW IN 15.0 INCH PIPE IS	9.1	INCHES	
PIPE-FLOW VELOCITY (FEET/SEC.) =	8.25		
ESTIMATED PIPE DIAMETER (INCH) =	15.00	NUMBER OF PIPES =	1
PIPE-FLOW (CFS) =	6.46		
PIPE TRAVEL TIME (MIN.) =	0.18	Tc (MIN.) =	10.46
LONGEST FLOWPATH FROM NODE 1300.00 TO NODE 1306.00 =	1176.60	FEET.	

=====

END OF STUDY SUMMARY:  
TOTAL AREA (ACRES) = 2.7 TC (MIN.) = 10.46  
PEAK FLOW RATE (CFS) = 6.46

-----  
END OF RATIONAL METHOD ANALYSIS

□

1600P100.RES

1600P100.RES

\*\*\*\*\*

RATIONAL METHOD HYDROLOGY COMPUTER PROGRAM PACKAGE
Reference: SAN DIEGO COUNTY FLOOD CONTROL DISTRICT
2003,1985,1981 HYDROLOGY MANUAL
(c) Copyright 1982-2016 Advanced Engineering Software (aes)
Ver. 23.0 Release Date: 07/01/2016 License ID 1509

Analysis prepared by:

\*\*\*\*\* DESCRIPTION OF STUDY \*\*\*\*\*
\* 4409 NAKANO \*
\* SYSTEM 1600 - PROPOSED CONDITIONS \*
\* 100 YEAR STORM EVENT \*
\*\*\*\*\*

FILE NAME: 1600P100.DAT
TIME/DATE OF STUDY: 15:38 06/14/2022

USER SPECIFIED HYDROLOGY AND HYDRAULIC MODEL INFORMATION:

2003 SAN DIEGO MANUAL CRITERIA

USER SPECIFIED STORM EVENT(YEAR) = 100.00
6-HOUR DURATION PRECIPITATION (INCHES) = 2.400
SPECIFIED MINIMUM PIPE SIZE(INCH) = 18.00
SPECIFIED PERCENT OF GRADIENTS(DECIMAL) TO USE FOR FRICTION SLOPE = 0.95
SAN DIEGO HYDROLOGY MANUAL "C"-VALUES USED FOR RATIONAL METHOD
\*CITY OF CHULA VISTA TIME-OF-CONCENTRATION MODEL SELECTED.\*
(BASED ON 07/2002 ADOPTED MANUAL)

NOTE: USE MODIFIED RATIONAL METHOD PROCEDURES FOR CONFLUENCE ANALYSIS

\*USER-DEFINED STREET-SECTIONS FOR COUPLED PIPEFLOW AND STREETFLOW MODEL\*

Table with 10 columns: NO., WIDTH (FT), CROSSFALL (FT), IN- / SIDE, OUT- / SIDE/ WAY, HEIGHT (FT), CURB / GUTTER, LIP (FT), HIKE (FT), MANNING FACTOR (n). Row 1: 1, 30.0, 20.0, 0.018/0.018, 0.020, 0.67, 2.00, 0.0313, 0.167, 0.0150

GLOBAL STREET FLOW-DEPTH CONSTRAINTS:

- 1. Relative Flow-Depth = 0.00 FEET as (Maximum Allowable Street Flow Depth) - (Top-of-Curb)
2. (Depth)\*(Velocity) Constraint = 6.0 (FT\*FT/S)
\*SIZE PIPE WITH A FLOW CAPACITY GREATER THAN OR EQUAL TO THE UPSTREAM TRIBUTARY PIPE.\*

\*\*\*\*\*
FLOW PROCESS FROM NODE 1600.00 TO NODE 1601.00 IS CODE = 22
\*\*\*\*\*

>>>>RATIONAL METHOD INITIAL SUBAREA ANALYSIS<<<<

\*USER SPECIFIED(SUBAREA):
USER-SPECIFIED RUNOFF COEFFICIENT = .6000
USER SPECIFIED Tc(MIN.) = 5.000
100 YEAR RAINFALL INTENSITY(INCH/HOUR) = 6.323
SUBAREA RUNOFF(CFS) = 0.49
TOTAL AREA(ACRES) = 0.13 TOTAL RUNOFF(CFS) = 0.49

\*\*\*\*\*

FLOW PROCESS FROM NODE 1601.00 TO NODE 1602.00 IS CODE = 51

>>>>COMPUTE TRAPEZOIDAL CHANNEL FLOW<<<<
>>>>TRAVELTIME THRU SUBAREA (EXISTING ELEMENT)<<<<

ELEVATION DATA: UPSTREAM(FEET) = 178.00 DOWNSTREAM(FEET) = 140.00
CHANNEL LENGTH THRU SUBAREA(FEET) = 126.00 CHANNEL SLOPE = 0.3016
CHANNEL BASE(FEET) = 10.00 "Z" FACTOR = 50.000
MANNING'S FACTOR = 0.045 MAXIMUM DEPTH(FEET) = 2.00
100 YEAR RAINFALL INTENSITY(INCH/HOUR) = 5.763

\*USER SPECIFIED(SUBAREA):
USER-SPECIFIED RUNOFF COEFFICIENT = .6000
TRAVEL TIME COMPUTED USING ESTIMATED FLOW(CFS) = 2.37
TRAVEL TIME THRU SUBAREA BASED ON VELOCITY(FEET/SEC.) = 2.71
AVERAGE FLOW DEPTH(FEET) = 0.07 TRAVEL TIME(MIN.) = 0.77
Tc(MIN.) = 5.77
SUBAREA AREA(ACRES) = 1.09 SUBAREA RUNOFF(CFS) = 3.77
AREA-AVERAGE RUNOFF COEFFICIENT = 0.600
TOTAL AREA(ACRES) = 1.2 PEAK FLOW RATE(CFS) = 4.22

END OF SUBAREA CHANNEL FLOW HYDRAULICS:
DEPTH(FEET) = 0.09 FLOW VELOCITY(FEET/SEC.) = 3.04
LONGEST FLOWPATH FROM NODE 1600.00 TO NODE 1602.00 = 790.00 FEET.

\*\*\*\*\*
FLOW PROCESS FROM NODE 1602.00 TO NODE 1605.00 IS CODE = 51

>>>>COMPUTE TRAPEZOIDAL CHANNEL FLOW<<<<
>>>>TRAVELTIME THRU SUBAREA (EXISTING ELEMENT)<<<<

ELEVATION DATA: UPSTREAM(FEET) = 141.00 DOWNSTREAM(FEET) = 116.00
CHANNEL LENGTH THRU SUBAREA(FEET) = 49.00 CHANNEL SLOPE = 0.5102
CHANNEL BASE(FEET) = 3.00 "Z" FACTOR = 3.000
MANNING'S FACTOR = 0.015 MAXIMUM DEPTH(FEET) = 0.50
CHANNEL FLOW THRU SUBAREA(CFS) = 4.22

FLOW VELOCITY(FEET/SEC.) = 13.61 FLOW DEPTH(FEET) = 0.09
TRAVEL TIME(MIN.) = 0.06 Tc(MIN.) = 5.83
LONGEST FLOWPATH FROM NODE 1600.00 TO NODE 1605.00 = 839.00 FEET.

\*\*\*\*\*
FLOW PROCESS FROM NODE 1605.00 TO NODE 1607.00 IS CODE = 51

>>>>COMPUTE TRAPEZOIDAL CHANNEL FLOW<<<<
>>>>TRAVELTIME THRU SUBAREA (EXISTING ELEMENT)<<<<

ELEVATION DATA: UPSTREAM(FEET) = 118.00 DOWNSTREAM(FEET) = 116.00
CHANNEL LENGTH THRU SUBAREA(FEET) = 430.80 CHANNEL SLOPE = 0.0046
CHANNEL BASE(FEET) = 1.00 "Z" FACTOR = 2.000
MANNING'S FACTOR = 0.015 MAXIMUM DEPTH(FEET) = 1.00
100 YEAR RAINFALL INTENSITY(INCH/HOUR) = 4.735

\*USER SPECIFIED(SUBAREA):
USER-SPECIFIED RUNOFF COEFFICIENT = .5500
TRAVEL TIME COMPUTED USING ESTIMATED FLOW(CFS) = 5.42
TRAVEL TIME THRU SUBAREA BASED ON VELOCITY(FEET/SEC.) = 3.60
AVERAGE FLOW DEPTH(FEET) = 0.65 TRAVEL TIME(MIN.) = 2.00
Tc(MIN.) = 7.83
SUBAREA AREA(ACRES) = 0.92 SUBAREA RUNOFF(CFS) = 2.40
AREA-AVERAGE RUNOFF COEFFICIENT = 0.579
TOTAL AREA(ACRES) = 2.1 PEAK FLOW RATE(CFS) = 5.86

END OF SUBAREA CHANNEL FLOW HYDRAULICS:
DEPTH(FEET) = 0.68 FLOW VELOCITY(FEET/SEC.) = 3.64

1600P100.RES

LONGEST FLOWPATH FROM NODE 1600.00 TO NODE 1607.00 = 1269.80 FEET.

\*\*\*\*\*  
FLOW PROCESS FROM NODE 1608.00 TO NODE 1607.00 IS CODE = 81

-----  
>>>>ADDITION OF SUBAREA TO MAINLINE PEAK FLOW<<<<<

=====

100 YEAR RAINFALL INTENSITY (INCH/HOUR) =	4.735
*USER SPECIFIED (SUBAREA):	
USER-SPECIFIED RUNOFF COEFFICIENT =	.5500
AREA-AVERAGE RUNOFF COEFFICIENT =	0.5745
SUBAREA AREA (ACRES) =	0.35
SUBAREA RUNOFF (CFS) =	0.91
TOTAL AREA (ACRES) =	2.5
TOTAL RUNOFF (CFS) =	6.77
TC (MIN.) =	7.83

\*\*\*\*\*  
FLOW PROCESS FROM NODE 1609.00 TO NODE 1609.00 IS CODE = 51

-----  
>>>>COMPUTE TRAPEZOIDAL CHANNEL FLOW<<<<<  
>>>>TRAVELTIME THRU SUBAREA (EXISTING ELEMENT)<<<<<

=====

ELEVATION DATA: UPSTREAM (FEET) =	116.00	DOWNSTREAM (FEET) =	98.00
CHANNEL LENGTH THRU SUBAREA (FEET) =	664.00	CHANNEL SLOPE =	0.0271
CHANNEL BASE (FEET) =	3.00	"Z" FACTOR =	3.000
MANNING'S FACTOR =	0.015	MAXIMUM DEPTH (FEET) =	0.50
100 YEAR RAINFALL INTENSITY (INCH/HOUR) =	4.156		
*USER SPECIFIED (SUBAREA):			
USER-SPECIFIED RUNOFF COEFFICIENT =	.5000		
TRAVEL TIME COMPUTED USING ESTIMATED FLOW (CFS) =	7.63		
TRAVEL TIME THRU SUBAREA BASED ON VELOCITY (FEET/SEC.) =	6.31		
AVERAGE FLOW DEPTH (FEET) =	0.31	TRAVEL TIME (MIN.) =	1.75
Tc (MIN.) =	9.58		
SUBAREA AREA (ACRES) =	0.82	SUBAREA RUNOFF (CFS) =	1.70
AREA-AVERAGE RUNOFF COEFFICIENT =	0.556		
TOTAL AREA (ACRES) =	3.3	PEAK FLOW RATE (CFS) =	7.65

END OF SUBAREA CHANNEL FLOW HYDRAULICS:  
DEPTH (FEET) = 0.31 FLOW VELOCITY (FEET/SEC.) = 6.33  
LONGEST FLOWPATH FROM NODE 1600.00 TO NODE 1609.00 = 1933.80 FEET.

-----  
END OF STUDY SUMMARY:  
TOTAL AREA (ACRES) = 3.3 TC (MIN.) = 9.58  
PEAK FLOW RATE (CFS) = 7.65

-----  
END OF RATIONAL METHOD ANALYSIS

□

## **APPENDIX 4**

### **Hydraulic Calculations**

To be completed during Final Engineering

## **APPENDIX 5**

### **Preliminary Detention Analysis**



PROJECT DESIGN CONSULTANTS

PLANNING | LANDSCAPE ARCHITECTURE  
ENGINEERING | SURVEY

WWW.PROJECTDESIGN.COM

PROJECT Nakano BMP System

SUBJECT MWS

PAGE : \_\_\_\_\_ OF \_\_\_\_\_ JOB NO. : \_\_\_\_\_

DRAWN BY : J.N. DATE : \_\_\_\_\_

CHECKED BY : \_\_\_\_\_ DATE : \_\_\_\_\_

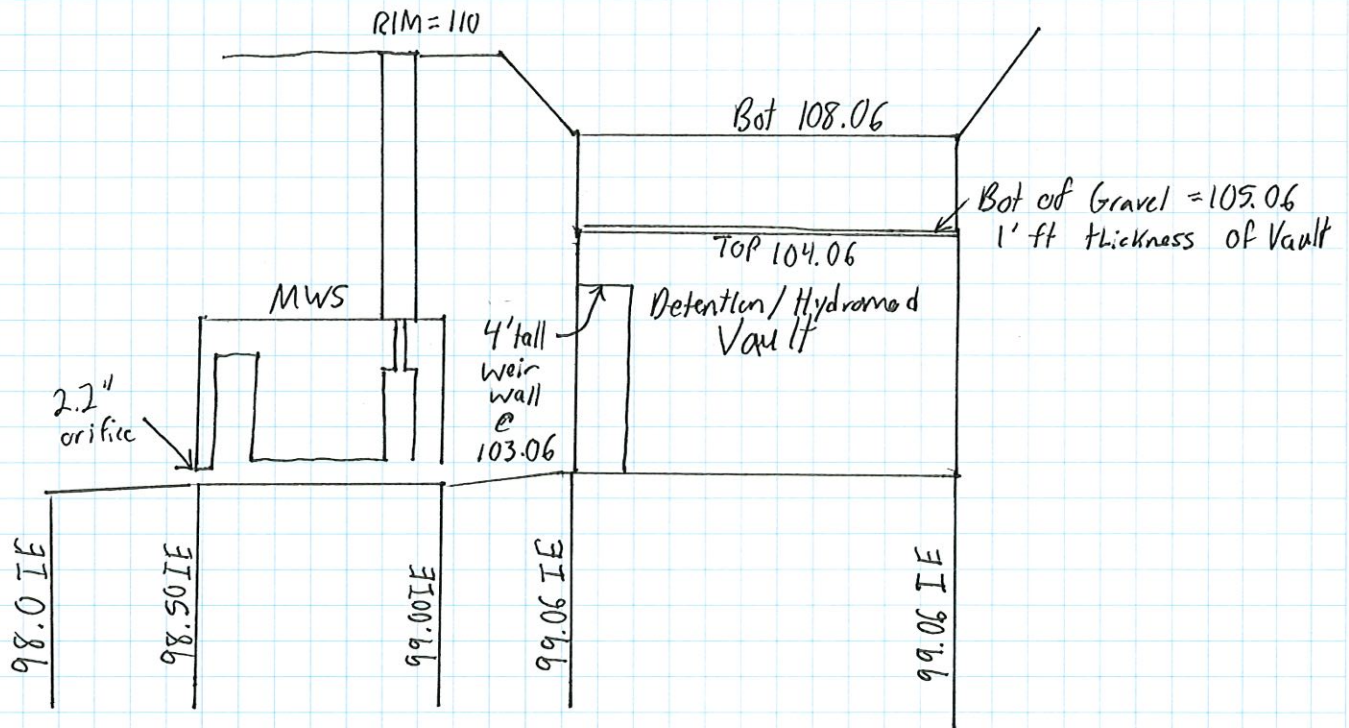

Detention/Hydromad Vault

12,376 ft<sup>2</sup> Area  
5 ft Depth

2.2" orifice @ Bot MWS Elevation 98.5'

4' Weir Wall @ 103.06' w/ 8' length  
for By pass + Emergency overflow

Inflow  $Q_{100} = 29.0$  cfs

outflow  $Q_{detained-100yr} = 1.55$  cfs



PROJECT DESIGN CONSULTANTS

PLANNING | LANDSCAPE ARCHITECTURE  
ENGINEERING | SURVEY

WWW.PROJECTDESIGN.COM

PROJECT NAKANO BMP System

SUBJECT \_\_\_\_\_

PAGE : \_\_\_\_\_ OF \_\_\_\_\_ JOB NO. : \_\_\_\_\_

DRAWN BY : J.N. DATE : 6/22/22

CHECKED BY : \_\_\_\_\_ DATE : \_\_\_\_\_

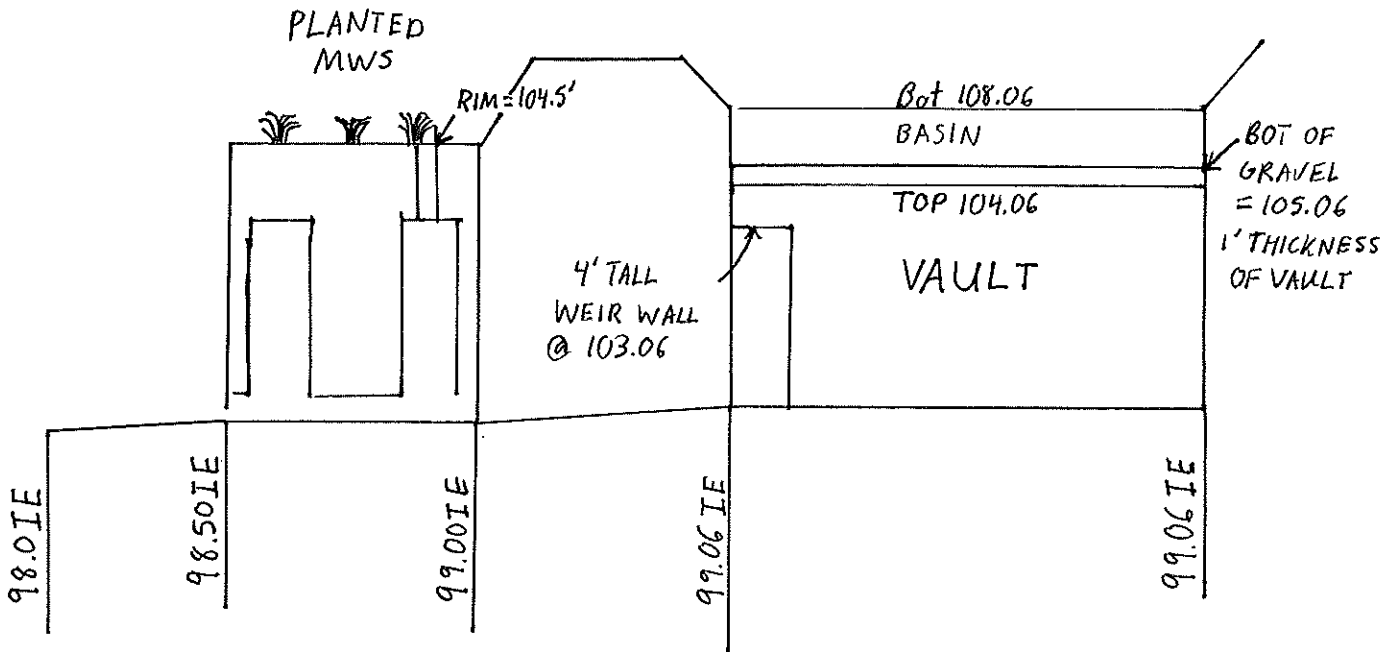

VAULT  
12,376 ft<sup>2</sup> AREA  
5 ft DEPTH

2 - 1.48" ORIFICES @ BOT MWS ELEV = 98.5' (EQUATES TO 1 - 2.2" ORIFICE)

4' WEIR WALL @ 103.06' w/ 8' LENGTH

FOR BYPASS + EMERGENCY OVERFLOW

Inflow  $Q_{100} = 31.0 \text{ cfs}$

Outflow  $Q_{\text{DETAINED } 100} = 1.55 \text{ cfs}$

# Detention Vault

---

## Project Summary

---

Title	System 1000
Engineer	PDC
Company	PDC
Date	6/17/2022

---

---

## Notes

---



## Table of Contents

	User Notifications	2
	Master Network Summary	3
CM-1	Read Hydrograph	4
1 (OUT)	Time vs. Elevation	5
1	Time vs. Volume	20
1		
	Elevation-Area Volume Curve	35
	Volume Equations	36
Outlet#1	Outlet Input Data	37
1		
	Elevation-Volume-Flow Table (Pond)	41
1 (IN)		
	Level Pool Pond Routing Summary	43
	Pond Inflow Summary	44

# Detention Vault

Subsection: User Notifications

User Notifications?	No user notifications generated.
---------------------	----------------------------------

## Detention Vault

Subsection: Master Network Summary

### Catchments Summary

Label	Scenario	Return Event (years)	Hydrograph Volume (ac-ft)	Time to Peak (min)	Peak Flow (ft <sup>3</sup> /s)
CM-1	EX10	0	1.430	248.000	31.00

### Node Summary

Label	Scenario	Return Event (years)	Hydrograph Volume (ac-ft)	Time to Peak (min)	Peak Flow (ft <sup>3</sup> /s)
O-1	EX10	0	1.034	308.000	1.55

### Pond Summary

Label	Scenario	Return Event (years)	Hydrograph Volume (ac-ft)	Time to Peak (min)	Peak Flow (ft <sup>3</sup> /s)	Maximum Water Surface Elevation (ft)	Maximum Pond Storage (ac-ft)
1 (IN)	EX10	0	1.430	248.000	31.00	(N/A)	(N/A)
1 (OUT)	EX10	0	1.034	308.000	1.55	103.20	1.224

## Detention Vault

Subsection: Read Hydrograph  
 Label: CM-1  
 Scenario: EX10

Return Event: 100 years  
 Storm Event:

Peak Discharge	31.00 ft <sup>3</sup> /s
Time to Peak	248.000 min
Hydrograph Volume	1.430 ac-ft

### HYDROGRAPH ORDINATES (ft<sup>3</sup>/s)

Output Time Increment = 8.000 min

Time on left represents time for first value in each row.

Time (min)	Flow (ft <sup>3</sup> /s)	Flow (ft <sup>3</sup> /s)	Flow (ft <sup>3</sup> /s)	Flow (ft <sup>3</sup> /s)	Flow (ft <sup>3</sup> /s)
0.000	0.00	1.00	1.00	1.10	1.10
40.000	1.10	1.20	1.20	1.20	1.30
80.000	1.30	1.30	1.40	1.40	1.50
120.000	1.60	1.60	1.70	1.80	1.90
160.000	2.00	2.10	2.20	2.50	2.60
200.000	3.00	3.30	4.00	4.50	6.70
240.000	12.00	31.00	5.30	3.60	2.80
280.000	2.30	2.00	1.80	1.60	1.50
320.000	1.40	1.30	1.20	1.20	1.10
360.000	1.10	0.00	(N/A)	(N/A)	(N/A)

## Detention Vault

Subsection: Time vs. Elevation  
 Label: 1 (OUT)  
 Scenario: EX10

Return Event: 100 years  
 Storm Event:

### Time vs. Elevation (ft)

**Output Time increment = 1.000 min**  
**Time on left represents time for first value in each row.**

Time (min)	Elevation (ft)	Elevation (ft)	Elevation (ft)	Elevation (ft)	Elevation (ft)
0.000	99.00	99.00	99.00	99.00	99.00
5.000	99.01	99.01	99.02	99.02	99.03
10.000	99.03	99.04	99.04	99.05	99.06
15.000	99.06	99.07	99.07	99.08	99.09
20.000	99.09	99.10	99.10	99.11	99.11
25.000	99.12	99.12	99.13	99.13	99.14
30.000	99.14	99.15	99.15	99.16	99.16
35.000	99.16	99.17	99.17	99.18	99.18
40.000	99.19	99.19	99.20	99.20	99.21
45.000	99.21	99.22	99.22	99.23	99.23
50.000	99.24	99.24	99.25	99.25	99.26
55.000	99.26	99.27	99.27	99.28	99.28
60.000	99.29	99.30	99.30	99.31	99.31
65.000	99.32	99.32	99.33	99.33	99.34
70.000	99.34	99.35	99.35	99.36	99.36
75.000	99.37	99.38	99.38	99.39	99.39
80.000	99.40	99.40	99.41	99.42	99.42
85.000	99.43	99.43	99.44	99.44	99.45
90.000	99.45	99.46	99.47	99.47	99.48
95.000	99.48	99.49	99.50	99.50	99.51
100.000	99.51	99.52	99.53	99.53	99.54
105.000	99.54	99.55	99.56	99.56	99.57
110.000	99.57	99.58	99.59	99.59	99.60
115.000	99.61	99.61	99.62	99.63	99.63
120.000	99.64	99.65	99.65	99.66	99.67
125.000	99.68	99.68	99.69	99.70	99.70
130.000	99.71	99.72	99.72	99.73	99.74
135.000	99.75	99.75	99.76	99.77	99.78
140.000	99.78	99.79	99.80	99.81	99.81
145.000	99.82	99.83	99.84	99.85	99.85
150.000	99.86	99.87	99.88	99.89	99.90
155.000	99.90	99.91	99.92	99.93	99.94
160.000	99.95	99.96	99.96	99.97	99.98
165.000	99.99	100.00	100.01	100.02	100.03
170.000	100.04	100.05	100.06	100.06	100.07
175.000	100.08	100.09	100.10	100.11	100.12
180.000	100.13	100.14	100.15	100.17	100.18
185.000	100.19	100.20	100.21	100.22	100.23
190.000	100.24	100.25	100.27	100.28	100.29
195.000	100.30	100.31	100.33	100.34	100.35

## Detention Vault

Subsection: Time vs. Elevation  
 Label: 1 (OUT)  
 Scenario: EX10

Return Event: 100 years  
 Storm Event:

### Time vs. Elevation (ft)

**Output Time increment = 1.000 min**  
**Time on left represents time for first value in each row.**

Time (min)	Elevation (ft)	Elevation (ft)	Elevation (ft)	Elevation (ft)	Elevation (ft)
200.000	100.37	100.38	100.39	100.41	100.42
205.000	100.43	100.45	100.46	100.48	100.49
210.000	100.51	100.52	100.54	100.56	100.57
215.000	100.59	100.61	100.63	100.64	100.66
220.000	100.68	100.70	100.72	100.74	100.76
225.000	100.78	100.80	100.83	100.85	100.88
230.000	100.91	100.94	100.97	101.00	101.03
235.000	101.07	101.11	101.16	101.21	101.26
240.000	101.31	101.37	101.44	101.53	101.62
245.000	101.73	101.84	101.97	102.11	102.25
250.000	102.37	102.48	102.57	102.65	102.71
255.000	102.76	102.79	102.81	102.83	102.85
260.000	102.87	102.89	102.91	102.93	102.94
265.000	102.96	102.98	102.99	103.00	103.02
270.000	103.03	103.04	103.06	103.07	103.08
275.000	103.09	103.10	103.11	103.12	103.13
280.000	103.13	103.14	103.15	103.15	103.16
285.000	103.16	103.17	103.17	103.17	103.18
290.000	103.18	103.18	103.19	103.19	103.19
295.000	103.19	103.19	103.20	103.20	103.20
300.000	103.20	103.20	103.20	103.20	103.20
305.000	103.20	103.20	103.20	103.20	103.20
310.000	103.20	103.20	103.20	103.20	103.20
315.000	103.20	103.20	103.20	103.20	103.20
320.000	103.20	103.20	103.20	103.20	103.20
325.000	103.20	103.19	103.19	103.19	103.19
330.000	103.19	103.19	103.19	103.19	103.19
335.000	103.19	103.19	103.19	103.18	103.18
340.000	103.18	103.18	103.18	103.18	103.18
345.000	103.18	103.18	103.18	103.18	103.18
350.000	103.18	103.18	103.18	103.17	103.17
355.000	103.17	103.17	103.17	103.17	103.17
360.000	103.17	103.17	103.17	103.17	103.16
365.000	103.16	103.16	103.15	103.15	103.14
370.000	103.14	103.14	103.13	103.13	103.12
375.000	103.12	103.12	103.12	103.11	103.11
380.000	103.11	103.10	103.10	103.10	103.10
385.000	103.10	103.09	103.09	103.09	103.09
390.000	103.09	103.08	103.08	103.08	103.08
395.000	103.08	103.08	103.07	103.07	103.07
400.000	103.07	103.07	103.07	103.06	103.06

## Detention Vault

Subsection: Time vs. Elevation  
 Label: 1 (OUT)  
 Scenario: EX10

Return Event: 100 years  
 Storm Event:

### Time vs. Elevation (ft)

**Output Time increment = 1.000 min**  
**Time on left represents time for first value in each row.**

Time (min)	Elevation (ft)	Elevation (ft)	Elevation (ft)	Elevation (ft)	Elevation (ft)
405.000	103.06	103.06	103.06	103.06	103.06
410.000	103.06	103.05	103.05	103.05	103.05
415.000	103.05	103.05	103.05	103.05	103.04
420.000	103.04	103.04	103.04	103.04	103.04
425.000	103.04	103.04	103.03	103.03	103.03
430.000	103.03	103.03	103.03	103.03	103.03
435.000	103.02	103.02	103.02	103.02	103.02
440.000	103.02	103.02	103.02	103.01	103.01
445.000	103.01	103.01	103.01	103.01	103.01
450.000	103.01	103.00	103.00	103.00	103.00
455.000	103.00	103.00	103.00	103.00	102.99
460.000	102.99	102.99	102.99	102.99	102.99
465.000	102.99	102.99	102.98	102.98	102.98
470.000	102.98	102.98	102.98	102.98	102.98
475.000	102.97	102.97	102.97	102.97	102.97
480.000	102.97	102.97	102.97	102.96	102.96
485.000	102.96	102.96	102.96	102.96	102.96
490.000	102.96	102.95	102.95	102.95	102.95
495.000	102.95	102.95	102.95	102.95	102.94
500.000	102.94	102.94	102.94	102.94	102.94
505.000	102.94	102.94	102.93	102.93	102.93
510.000	102.93	102.93	102.93	102.93	102.93
515.000	102.92	102.92	102.92	102.92	102.92
520.000	102.92	102.92	102.92	102.91	102.91
525.000	102.91	102.91	102.91	102.91	102.91
530.000	102.91	102.90	102.90	102.90	102.90
535.000	102.90	102.90	102.90	102.90	102.89
540.000	102.89	102.89	102.89	102.89	102.89
545.000	102.89	102.89	102.88	102.88	102.88
550.000	102.88	102.88	102.88	102.88	102.88
555.000	102.87	102.87	102.87	102.87	102.87
560.000	102.87	102.87	102.87	102.86	102.86
565.000	102.86	102.86	102.86	102.86	102.86
570.000	102.86	102.85	102.85	102.85	102.85
575.000	102.85	102.85	102.85	102.85	102.84
580.000	102.84	102.84	102.84	102.84	102.84
585.000	102.84	102.84	102.83	102.83	102.83
590.000	102.83	102.83	102.83	102.83	102.83
595.000	102.82	102.82	102.82	102.82	102.82
600.000	102.82	102.82	102.82	102.82	102.81
605.000	102.81	102.81	102.81	102.81	102.81

## Detention Vault

Subsection: Time vs. Elevation  
 Label: 1 (OUT)  
 Scenario: EX10

Return Event: 100 years  
 Storm Event:

### Time vs. Elevation (ft)

**Output Time increment = 1.000 min**  
**Time on left represents time for first value in each row.**

Time (min)	Elevation (ft)	Elevation (ft)	Elevation (ft)	Elevation (ft)	Elevation (ft)
610.000	102.81	102.81	102.80	102.80	102.80
615.000	102.80	102.80	102.80	102.80	102.80
620.000	102.79	102.79	102.79	102.79	102.79
625.000	102.79	102.79	102.79	102.78	102.78
630.000	102.78	102.78	102.78	102.78	102.78
635.000	102.78	102.77	102.77	102.77	102.77
640.000	102.77	102.77	102.77	102.77	102.76
645.000	102.76	102.76	102.76	102.76	102.76
650.000	102.76	102.76	102.76	102.75	102.75
655.000	102.75	102.75	102.75	102.75	102.75
660.000	102.75	102.74	102.74	102.74	102.74
665.000	102.74	102.74	102.74	102.74	102.73
670.000	102.73	102.73	102.73	102.73	102.73
675.000	102.73	102.73	102.72	102.72	102.72
680.000	102.72	102.72	102.72	102.72	102.72
685.000	102.71	102.71	102.71	102.71	102.71
690.000	102.71	102.71	102.71	102.71	102.70
695.000	102.70	102.70	102.70	102.70	102.70
700.000	102.70	102.70	102.69	102.69	102.69
705.000	102.69	102.69	102.69	102.69	102.69
710.000	102.68	102.68	102.68	102.68	102.68
715.000	102.68	102.68	102.68	102.67	102.67
720.000	102.67	102.67	102.67	102.67	102.67
725.000	102.67	102.67	102.66	102.66	102.66
730.000	102.66	102.66	102.66	102.66	102.66
735.000	102.65	102.65	102.65	102.65	102.65
740.000	102.65	102.65	102.65	102.64	102.64
745.000	102.64	102.64	102.64	102.64	102.64
750.000	102.64	102.64	102.63	102.63	102.63
755.000	102.63	102.63	102.63	102.63	102.63
760.000	102.62	102.62	102.62	102.62	102.62
765.000	102.62	102.62	102.62	102.61	102.61
770.000	102.61	102.61	102.61	102.61	102.61
775.000	102.61	102.61	102.60	102.60	102.60
780.000	102.60	102.60	102.60	102.60	102.60
785.000	102.59	102.59	102.59	102.59	102.59
790.000	102.59	102.59	102.59	102.58	102.58
795.000	102.58	102.58	102.58	102.58	102.58
800.000	102.58	102.58	102.57	102.57	102.57
805.000	102.57	102.57	102.57	102.57	102.57
810.000	102.56	102.56	102.56	102.56	102.56



## Detention Vault

Subsection: Time vs. Elevation  
 Label: 1 (OUT)  
 Scenario: EX10

Return Event: 100 years  
 Storm Event:

### Time vs. Elevation (ft)

**Output Time increment = 1.000 min**  
**Time on left represents time for first value in each row.**

Time (min)	Elevation (ft)	Elevation (ft)	Elevation (ft)	Elevation (ft)	Elevation (ft)
815.000	102.56	102.56	102.56	102.55	102.55
820.000	102.55	102.55	102.55	102.55	102.55
825.000	102.55	102.55	102.54	102.54	102.54
830.000	102.54	102.54	102.54	102.54	102.54
835.000	102.53	102.53	102.53	102.53	102.53
840.000	102.53	102.53	102.53	102.53	102.52
845.000	102.52	102.52	102.52	102.52	102.52
850.000	102.52	102.52	102.51	102.51	102.51
855.000	102.51	102.51	102.51	102.51	102.51
860.000	102.50	102.50	102.50	102.50	102.50
865.000	102.50	102.50	102.50	102.50	102.49
870.000	102.49	102.49	102.49	102.49	102.49
875.000	102.49	102.49	102.48	102.48	102.48
880.000	102.48	102.48	102.48	102.48	102.48
885.000	102.48	102.47	102.47	102.47	102.47
890.000	102.47	102.47	102.47	102.47	102.46
895.000	102.46	102.46	102.46	102.46	102.46
900.000	102.46	102.46	102.46	102.45	102.45
905.000	102.45	102.45	102.45	102.45	102.45
910.000	102.45	102.44	102.44	102.44	102.44
915.000	102.44	102.44	102.44	102.44	102.44
920.000	102.43	102.43	102.43	102.43	102.43
925.000	102.43	102.43	102.43	102.42	102.42
930.000	102.42	102.42	102.42	102.42	102.42
935.000	102.42	102.42	102.41	102.41	102.41
940.000	102.41	102.41	102.41	102.41	102.41
945.000	102.40	102.40	102.40	102.40	102.40
950.000	102.40	102.40	102.40	102.40	102.39
955.000	102.39	102.39	102.39	102.39	102.39
960.000	102.39	102.39	102.39	102.38	102.38
965.000	102.38	102.38	102.38	102.38	102.38
970.000	102.38	102.37	102.37	102.37	102.37
975.000	102.37	102.37	102.37	102.37	102.37
980.000	102.36	102.36	102.36	102.36	102.36
985.000	102.36	102.36	102.36	102.35	102.35
990.000	102.35	102.35	102.35	102.35	102.35
995.000	102.35	102.35	102.34	102.34	102.34
1,000.000	102.34	102.34	102.34	102.34	102.34
1,005.000	102.34	102.33	102.33	102.33	102.33
1,010.000	102.33	102.33	102.33	102.33	102.32
1,015.000	102.32	102.32	102.32	102.32	102.32

## Detention Vault

Subsection: Time vs. Elevation  
 Label: 1 (OUT)  
 Scenario: EX10

Return Event: 100 years  
 Storm Event:

### Time vs. Elevation (ft)

**Output Time increment = 1.000 min**  
**Time on left represents time for first value in each row.**

Time (min)	Elevation (ft)	Elevation (ft)	Elevation (ft)	Elevation (ft)	Elevation (ft)
1,020.000	102.32	102.32	102.32	102.31	102.31
1,025.000	102.31	102.31	102.31	102.31	102.31
1,030.000	102.31	102.31	102.30	102.30	102.30
1,035.000	102.30	102.30	102.30	102.30	102.30
1,040.000	102.29	102.29	102.29	102.29	102.29
1,045.000	102.29	102.29	102.29	102.29	102.28
1,050.000	102.28	102.28	102.28	102.28	102.28
1,055.000	102.28	102.28	102.28	102.27	102.27
1,060.000	102.27	102.27	102.27	102.27	102.27
1,065.000	102.27	102.26	102.26	102.26	102.26
1,070.000	102.26	102.26	102.26	102.26	102.26
1,075.000	102.25	102.25	102.25	102.25	102.25
1,080.000	102.25	102.25	102.25	102.25	102.24
1,085.000	102.24	102.24	102.24	102.24	102.24
1,090.000	102.24	102.24	102.24	102.23	102.23
1,095.000	102.23	102.23	102.23	102.23	102.23
1,100.000	102.23	102.22	102.22	102.22	102.22
1,105.000	102.22	102.22	102.22	102.22	102.22
1,110.000	102.21	102.21	102.21	102.21	102.21
1,115.000	102.21	102.21	102.21	102.21	102.20
1,120.000	102.20	102.20	102.20	102.20	102.20
1,125.000	102.20	102.20	102.20	102.19	102.19
1,130.000	102.19	102.19	102.19	102.19	102.19
1,135.000	102.19	102.18	102.18	102.18	102.18
1,140.000	102.18	102.18	102.18	102.18	102.18
1,145.000	102.17	102.17	102.17	102.17	102.17
1,150.000	102.17	102.17	102.17	102.17	102.16
1,155.000	102.16	102.16	102.16	102.16	102.16
1,160.000	102.16	102.16	102.16	102.15	102.15
1,165.000	102.15	102.15	102.15	102.15	102.15
1,170.000	102.15	102.15	102.14	102.14	102.14
1,175.000	102.14	102.14	102.14	102.14	102.14
1,180.000	102.14	102.13	102.13	102.13	102.13
1,185.000	102.13	102.13	102.13	102.13	102.13
1,190.000	102.12	102.12	102.12	102.12	102.12
1,195.000	102.12	102.12	102.12	102.11	102.11
1,200.000	102.11	102.11	102.11	102.11	102.11
1,205.000	102.11	102.11	102.10	102.10	102.10
1,210.000	102.10	102.10	102.10	102.10	102.10
1,215.000	102.10	102.09	102.09	102.09	102.09
1,220.000	102.09	102.09	102.09	102.09	102.09

## Detention Vault

Subsection: Time vs. Elevation  
 Label: 1 (OUT)  
 Scenario: EX10

Return Event: 100 years  
 Storm Event:

### Time vs. Elevation (ft)

**Output Time increment = 1.000 min**  
**Time on left represents time for first value in each row.**

Time (min)	Elevation (ft)	Elevation (ft)	Elevation (ft)	Elevation (ft)	Elevation (ft)
1,225.000	102.08	102.08	102.08	102.08	102.08
1,230.000	102.08	102.08	102.08	102.08	102.07
1,235.000	102.07	102.07	102.07	102.07	102.07
1,240.000	102.07	102.07	102.07	102.06	102.06
1,245.000	102.06	102.06	102.06	102.06	102.06
1,250.000	102.06	102.06	102.05	102.05	102.05
1,255.000	102.05	102.05	102.05	102.05	102.05
1,260.000	102.05	102.04	102.04	102.04	102.04
1,265.000	102.04	102.04	102.04	102.04	102.04
1,270.000	102.03	102.03	102.03	102.03	102.03
1,275.000	102.03	102.03	102.03	102.03	102.02
1,280.000	102.02	102.02	102.02	102.02	102.02
1,285.000	102.02	102.02	102.02	102.01	102.01
1,290.000	102.01	102.01	102.01	102.01	102.01
1,295.000	102.01	102.01	102.00	102.00	102.00
1,300.000	102.00	102.00	102.00	102.00	102.00
1,305.000	102.00	101.99	101.99	101.99	101.99
1,310.000	101.99	101.99	101.99	101.99	101.99
1,315.000	101.98	101.98	101.98	101.98	101.98
1,320.000	101.98	101.98	101.98	101.98	101.97
1,325.000	101.97	101.97	101.97	101.97	101.97
1,330.000	101.97	101.97	101.97	101.96	101.96
1,335.000	101.96	101.96	101.96	101.96	101.96
1,340.000	101.96	101.96	101.96	101.95	101.95
1,345.000	101.95	101.95	101.95	101.95	101.95
1,350.000	101.95	101.95	101.94	101.94	101.94
1,355.000	101.94	101.94	101.94	101.94	101.94
1,360.000	101.94	101.93	101.93	101.93	101.93
1,365.000	101.93	101.93	101.93	101.93	101.93
1,370.000	101.92	101.92	101.92	101.92	101.92
1,375.000	101.92	101.92	101.92	101.92	101.91
1,380.000	101.91	101.91	101.91	101.91	101.91
1,385.000	101.91	101.91	101.91	101.90	101.90
1,390.000	101.90	101.90	101.90	101.90	101.90
1,395.000	101.90	101.90	101.89	101.89	101.89
1,400.000	101.89	101.89	101.89	101.89	101.89
1,405.000	101.89	101.89	101.88	101.88	101.88
1,410.000	101.88	101.88	101.88	101.88	101.88
1,415.000	101.88	101.87	101.87	101.87	101.87
1,420.000	101.87	101.87	101.87	101.87	101.87
1,425.000	101.86	101.86	101.86	101.86	101.86

## Detention Vault

Subsection: Time vs. Elevation  
 Label: 1 (OUT)  
 Scenario: EX10

Return Event: 100 years  
 Storm Event:

### Time vs. Elevation (ft)

**Output Time increment = 1.000 min**  
**Time on left represents time for first value in each row.**

Time (min)	Elevation (ft)	Elevation (ft)	Elevation (ft)	Elevation (ft)	Elevation (ft)
1,430.000	101.86	101.86	101.86	101.86	101.85
1,435.000	101.85	101.85	101.85	101.85	101.85
1,440.000	101.85	101.85	101.85	101.85	101.84
1,445.000	101.84	101.84	101.84	101.84	101.84
1,450.000	101.84	101.84	101.84	101.83	101.83
1,455.000	101.83	101.83	101.83	101.83	101.83
1,460.000	101.83	101.83	101.82	101.82	101.82
1,465.000	101.82	101.82	101.82	101.82	101.82
1,470.000	101.82	101.81	101.81	101.81	101.81
1,475.000	101.81	101.81	101.81	101.81	101.81
1,480.000	101.81	101.80	101.80	101.80	101.80
1,485.000	101.80	101.80	101.80	101.80	101.80
1,490.000	101.79	101.79	101.79	101.79	101.79
1,495.000	101.79	101.79	101.79	101.79	101.78
1,500.000	101.78	101.78	101.78	101.78	101.78
1,505.000	101.78	101.78	101.78	101.78	101.77
1,510.000	101.77	101.77	101.77	101.77	101.77
1,515.000	101.77	101.77	101.77	101.76	101.76
1,520.000	101.76	101.76	101.76	101.76	101.76
1,525.000	101.76	101.76	101.76	101.75	101.75
1,530.000	101.75	101.75	101.75	101.75	101.75
1,535.000	101.75	101.75	101.74	101.74	101.74
1,540.000	101.74	101.74	101.74	101.74	101.74
1,545.000	101.74	101.73	101.73	101.73	101.73
1,550.000	101.73	101.73	101.73	101.73	101.73
1,555.000	101.73	101.72	101.72	101.72	101.72
1,560.000	101.72	101.72	101.72	101.72	101.72
1,565.000	101.71	101.71	101.71	101.71	101.71
1,570.000	101.71	101.71	101.71	101.71	101.71
1,575.000	101.70	101.70	101.70	101.70	101.70
1,580.000	101.70	101.70	101.70	101.70	101.69
1,585.000	101.69	101.69	101.69	101.69	101.69
1,590.000	101.69	101.69	101.69	101.69	101.68
1,595.000	101.68	101.68	101.68	101.68	101.68
1,600.000	101.68	101.68	101.68	101.67	101.67
1,605.000	101.67	101.67	101.67	101.67	101.67
1,610.000	101.67	101.67	101.67	101.66	101.66
1,615.000	101.66	101.66	101.66	101.66	101.66
1,620.000	101.66	101.66	101.65	101.65	101.65
1,625.000	101.65	101.65	101.65	101.65	101.65
1,630.000	101.65	101.65	101.64	101.64	101.64

## Detention Vault

Subsection: Time vs. Elevation  
 Label: 1 (OUT)  
 Scenario: EX10

Return Event: 100 years  
 Storm Event:

### Time vs. Elevation (ft)

**Output Time increment = 1.000 min**  
**Time on left represents time for first value in each row.**

Time (min)	Elevation (ft)	Elevation (ft)	Elevation (ft)	Elevation (ft)	Elevation (ft)
1,635.000	101.64	101.64	101.64	101.64	101.64
1,640.000	101.64	101.63	101.63	101.63	101.63
1,645.000	101.63	101.63	101.63	101.63	101.63
1,650.000	101.63	101.62	101.62	101.62	101.62
1,655.000	101.62	101.62	101.62	101.62	101.62
1,660.000	101.62	101.61	101.61	101.61	101.61
1,665.000	101.61	101.61	101.61	101.61	101.61
1,670.000	101.60	101.60	101.60	101.60	101.60
1,675.000	101.60	101.60	101.60	101.60	101.60
1,680.000	101.59	101.59	101.59	101.59	101.59
1,685.000	101.59	101.59	101.59	101.59	101.58
1,690.000	101.58	101.58	101.58	101.58	101.58
1,695.000	101.58	101.58	101.58	101.58	101.57
1,700.000	101.57	101.57	101.57	101.57	101.57
1,705.000	101.57	101.57	101.57	101.57	101.56
1,710.000	101.56	101.56	101.56	101.56	101.56
1,715.000	101.56	101.56	101.56	101.55	101.55
1,720.000	101.55	101.55	101.55	101.55	101.55
1,725.000	101.55	101.55	101.55	101.54	101.54
1,730.000	101.54	101.54	101.54	101.54	101.54
1,735.000	101.54	101.54	101.54	101.53	101.53
1,740.000	101.53	101.53	101.53	101.53	101.53
1,745.000	101.53	101.53	101.53	101.52	101.52
1,750.000	101.52	101.52	101.52	101.52	101.52
1,755.000	101.52	101.52	101.51	101.51	101.51
1,760.000	101.51	101.51	101.51	101.51	101.51
1,765.000	101.51	101.51	101.50	101.50	101.50
1,770.000	101.50	101.50	101.50	101.50	101.50
1,775.000	101.50	101.50	101.49	101.49	101.49
1,780.000	101.49	101.49	101.49	101.49	101.49
1,785.000	101.49	101.49	101.48	101.48	101.48
1,790.000	101.48	101.48	101.48	101.48	101.48
1,795.000	101.48	101.48	101.47	101.47	101.47
1,800.000	101.47	101.47	101.47	101.47	101.47
1,805.000	101.47	101.46	101.46	101.46	101.46
1,810.000	101.46	101.46	101.46	101.46	101.46
1,815.000	101.46	101.45	101.45	101.45	101.45
1,820.000	101.45	101.45	101.45	101.45	101.45
1,825.000	101.45	101.44	101.44	101.44	101.44
1,830.000	101.44	101.44	101.44	101.44	101.44
1,835.000	101.44	101.43	101.43	101.43	101.43

## Detention Vault

Subsection: Time vs. Elevation  
 Label: 1 (OUT)  
 Scenario: EX10

Return Event: 100 years  
 Storm Event:

### Time vs. Elevation (ft)

**Output Time increment = 1.000 min**  
**Time on left represents time for first value in each row.**

Time (min)	Elevation (ft)	Elevation (ft)	Elevation (ft)	Elevation (ft)	Elevation (ft)
1,840.000	101.43	101.43	101.43	101.43	101.43
1,845.000	101.43	101.42	101.42	101.42	101.42
1,850.000	101.42	101.42	101.42	101.42	101.42
1,855.000	101.42	101.41	101.41	101.41	101.41
1,860.000	101.41	101.41	101.41	101.41	101.41
1,865.000	101.41	101.40	101.40	101.40	101.40
1,870.000	101.40	101.40	101.40	101.40	101.40
1,875.000	101.40	101.39	101.39	101.39	101.39
1,880.000	101.39	101.39	101.39	101.39	101.39
1,885.000	101.39	101.38	101.38	101.38	101.38
1,890.000	101.38	101.38	101.38	101.38	101.38
1,895.000	101.38	101.37	101.37	101.37	101.37
1,900.000	101.37	101.37	101.37	101.37	101.37
1,905.000	101.37	101.36	101.36	101.36	101.36
1,910.000	101.36	101.36	101.36	101.36	101.36
1,915.000	101.36	101.35	101.35	101.35	101.35
1,920.000	101.35	101.35	101.35	101.35	101.35
1,925.000	101.35	101.34	101.34	101.34	101.34
1,930.000	101.34	101.34	101.34	101.34	101.34
1,935.000	101.34	101.33	101.33	101.33	101.33
1,940.000	101.33	101.33	101.33	101.33	101.33
1,945.000	101.33	101.32	101.32	101.32	101.32
1,950.000	101.32	101.32	101.32	101.32	101.32
1,955.000	101.32	101.31	101.31	101.31	101.31
1,960.000	101.31	101.31	101.31	101.31	101.31
1,965.000	101.31	101.30	101.30	101.30	101.30
1,970.000	101.30	101.30	101.30	101.30	101.30
1,975.000	101.30	101.30	101.29	101.29	101.29
1,980.000	101.29	101.29	101.29	101.29	101.29
1,985.000	101.29	101.29	101.28	101.28	101.28
1,990.000	101.28	101.28	101.28	101.28	101.28
1,995.000	101.28	101.28	101.27	101.27	101.27
2,000.000	101.27	101.27	101.27	101.27	101.27
2,005.000	101.27	101.27	101.26	101.26	101.26
2,010.000	101.26	101.26	101.26	101.26	101.26
2,015.000	101.26	101.26	101.25	101.25	101.25
2,020.000	101.25	101.25	101.25	101.25	101.25
2,025.000	101.25	101.25	101.25	101.24	101.24
2,030.000	101.24	101.24	101.24	101.24	101.24
2,035.000	101.24	101.24	101.24	101.23	101.23
2,040.000	101.23	101.23	101.23	101.23	101.23

## Detention Vault

Subsection: Time vs. Elevation  
 Label: 1 (OUT)  
 Scenario: EX10

Return Event: 100 years  
 Storm Event:

### Time vs. Elevation (ft)

**Output Time increment = 1.000 min**  
**Time on left represents time for first value in each row.**

Time (min)	Elevation (ft)	Elevation (ft)	Elevation (ft)	Elevation (ft)	Elevation (ft)
2,045.000	101.23	101.23	101.23	101.22	101.22
2,050.000	101.22	101.22	101.22	101.22	101.22
2,055.000	101.22	101.22	101.22	101.21	101.21
2,060.000	101.21	101.21	101.21	101.21	101.21
2,065.000	101.21	101.21	101.21	101.21	101.20
2,070.000	101.20	101.20	101.20	101.20	101.20
2,075.000	101.20	101.20	101.20	101.20	101.19
2,080.000	101.19	101.19	101.19	101.19	101.19
2,085.000	101.19	101.19	101.19	101.19	101.19
2,090.000	101.18	101.18	101.18	101.18	101.18
2,095.000	101.18	101.18	101.18	101.18	101.18
2,100.000	101.17	101.17	101.17	101.17	101.17
2,105.000	101.17	101.17	101.17	101.17	101.17
2,110.000	101.16	101.16	101.16	101.16	101.16
2,115.000	101.16	101.16	101.16	101.16	101.16
2,120.000	101.16	101.15	101.15	101.15	101.15
2,125.000	101.15	101.15	101.15	101.15	101.15
2,130.000	101.15	101.14	101.14	101.14	101.14
2,135.000	101.14	101.14	101.14	101.14	101.14
2,140.000	101.14	101.14	101.13	101.13	101.13
2,145.000	101.13	101.13	101.13	101.13	101.13
2,150.000	101.13	101.13	101.12	101.12	101.12
2,155.000	101.12	101.12	101.12	101.12	101.12
2,160.000	101.12	101.12	101.12	101.11	101.11
2,165.000	101.11	101.11	101.11	101.11	101.11
2,170.000	101.11	101.11	101.11	101.10	101.10
2,175.000	101.10	101.10	101.10	101.10	101.10
2,180.000	101.10	101.10	101.10	101.10	101.09
2,185.000	101.09	101.09	101.09	101.09	101.09
2,190.000	101.09	101.09	101.09	101.09	101.08
2,195.000	101.08	101.08	101.08	101.08	101.08
2,200.000	101.08	101.08	101.08	101.08	101.08
2,205.000	101.07	101.07	101.07	101.07	101.07
2,210.000	101.07	101.07	101.07	101.07	101.07
2,215.000	101.06	101.06	101.06	101.06	101.06
2,220.000	101.06	101.06	101.06	101.06	101.06
2,225.000	101.06	101.05	101.05	101.05	101.05
2,230.000	101.05	101.05	101.05	101.05	101.05
2,235.000	101.05	101.05	101.04	101.04	101.04
2,240.000	101.04	101.04	101.04	101.04	101.04
2,245.000	101.04	101.04	101.03	101.03	101.03

## Detention Vault

Subsection: Time vs. Elevation  
 Label: 1 (OUT)  
 Scenario: EX10

Return Event: 100 years  
 Storm Event:

### Time vs. Elevation (ft)

**Output Time increment = 1.000 min**  
**Time on left represents time for first value in each row.**

Time (min)	Elevation (ft)	Elevation (ft)	Elevation (ft)	Elevation (ft)	Elevation (ft)
2,250.000	101.03	101.03	101.03	101.03	101.03
2,255.000	101.03	101.03	101.03	101.02	101.02
2,260.000	101.02	101.02	101.02	101.02	101.02
2,265.000	101.02	101.02	101.02	101.02	101.01
2,270.000	101.01	101.01	101.01	101.01	101.01
2,275.000	101.01	101.01	101.01	101.01	101.01
2,280.000	101.00	101.00	101.00	101.00	101.00
2,285.000	101.00	101.00	101.00	101.00	101.00
2,290.000	100.99	100.99	100.99	100.99	100.99
2,295.000	100.99	100.99	100.99	100.99	100.99
2,300.000	100.99	100.98	100.98	100.98	100.98
2,305.000	100.98	100.98	100.98	100.98	100.98
2,310.000	100.98	100.98	100.97	100.97	100.97
2,315.000	100.97	100.97	100.97	100.97	100.97
2,320.000	100.97	100.97	100.97	100.96	100.96
2,325.000	100.96	100.96	100.96	100.96	100.96
2,330.000	100.96	100.96	100.96	100.96	100.95
2,335.000	100.95	100.95	100.95	100.95	100.95
2,340.000	100.95	100.95	100.95	100.95	100.95
2,345.000	100.94	100.94	100.94	100.94	100.94
2,350.000	100.94	100.94	100.94	100.94	100.94
2,355.000	100.93	100.93	100.93	100.93	100.93
2,360.000	100.93	100.93	100.93	100.93	100.93
2,365.000	100.93	100.92	100.92	100.92	100.92
2,370.000	100.92	100.92	100.92	100.92	100.92
2,375.000	100.92	100.92	100.91	100.91	100.91
2,380.000	100.91	100.91	100.91	100.91	100.91
2,385.000	100.91	100.91	100.91	100.90	100.90
2,390.000	100.90	100.90	100.90	100.90	100.90
2,395.000	100.90	100.90	100.90	100.90	100.89
2,400.000	100.89	100.89	100.89	100.89	100.89
2,405.000	100.89	100.89	100.89	100.89	100.89
2,410.000	100.88	100.88	100.88	100.88	100.88
2,415.000	100.88	100.88	100.88	100.88	100.88
2,420.000	100.88	100.87	100.87	100.87	100.87
2,425.000	100.87	100.87	100.87	100.87	100.87
2,430.000	100.87	100.87	100.86	100.86	100.86
2,435.000	100.86	100.86	100.86	100.86	100.86
2,440.000	100.86	100.86	100.86	100.86	100.85
2,445.000	100.85	100.85	100.85	100.85	100.85
2,450.000	100.85	100.85	100.85	100.85	100.85



## Detention Vault

Subsection: Time vs. Elevation  
 Label: 1 (OUT)  
 Scenario: EX10

Return Event: 100 years  
 Storm Event:

### Time vs. Elevation (ft)

**Output Time increment = 1.000 min**  
**Time on left represents time for first value in each row.**

Time (min)	Elevation (ft)	Elevation (ft)	Elevation (ft)	Elevation (ft)	Elevation (ft)
2,455.000	100.84	100.84	100.84	100.84	100.84
2,460.000	100.84	100.84	100.84	100.84	100.84
2,465.000	100.84	100.83	100.83	100.83	100.83
2,470.000	100.83	100.83	100.83	100.83	100.83
2,475.000	100.83	100.83	100.82	100.82	100.82
2,480.000	100.82	100.82	100.82	100.82	100.82
2,485.000	100.82	100.82	100.82	100.81	100.81
2,490.000	100.81	100.81	100.81	100.81	100.81
2,495.000	100.81	100.81	100.81	100.81	100.80
2,500.000	100.80	100.80	100.80	100.80	100.80
2,505.000	100.80	100.80	100.80	100.80	100.80
2,510.000	100.80	100.79	100.79	100.79	100.79
2,515.000	100.79	100.79	100.79	100.79	100.79
2,520.000	100.79	100.79	100.78	100.78	100.78
2,525.000	100.78	100.78	100.78	100.78	100.78
2,530.000	100.78	100.78	100.78	100.77	100.77
2,535.000	100.77	100.77	100.77	100.77	100.77
2,540.000	100.77	100.77	100.77	100.77	100.76
2,545.000	100.76	100.76	100.76	100.76	100.76
2,550.000	100.76	100.76	100.76	100.76	100.76
2,555.000	100.76	100.75	100.75	100.75	100.75
2,560.000	100.75	100.75	100.75	100.75	100.75
2,565.000	100.75	100.75	100.74	100.74	100.74
2,570.000	100.74	100.74	100.74	100.74	100.74
2,575.000	100.74	100.74	100.74	100.74	100.73
2,580.000	100.73	100.73	100.73	100.73	100.73
2,585.000	100.73	100.73	100.73	100.73	100.73
2,590.000	100.72	100.72	100.72	100.72	100.72
2,595.000	100.72	100.72	100.72	100.72	100.72
2,600.000	100.72	100.71	100.71	100.71	100.71
2,605.000	100.71	100.71	100.71	100.71	100.71
2,610.000	100.71	100.71	100.71	100.70	100.70
2,615.000	100.70	100.70	100.70	100.70	100.70
2,620.000	100.70	100.70	100.70	100.70	100.69
2,625.000	100.69	100.69	100.69	100.69	100.69
2,630.000	100.69	100.69	100.69	100.69	100.69
2,635.000	100.69	100.68	100.68	100.68	100.68
2,640.000	100.68	100.68	100.68	100.68	100.68
2,645.000	100.68	100.68	100.68	100.67	100.67
2,650.000	100.67	100.67	100.67	100.67	100.67
2,655.000	100.67	100.67	100.67	100.67	100.66

## Detention Vault

Subsection: Time vs. Elevation  
 Label: 1 (OUT)  
 Scenario: EX10

Return Event: 100 years  
 Storm Event:

### Time vs. Elevation (ft)

**Output Time increment = 1.000 min**  
**Time on left represents time for first value in each row.**

Time (min)	Elevation (ft)	Elevation (ft)	Elevation (ft)	Elevation (ft)	Elevation (ft)
2,660.000	100.66	100.66	100.66	100.66	100.66
2,665.000	100.66	100.66	100.66	100.66	100.66
2,670.000	100.66	100.65	100.65	100.65	100.65
2,675.000	100.65	100.65	100.65	100.65	100.65
2,680.000	100.65	100.65	100.64	100.64	100.64
2,685.000	100.64	100.64	100.64	100.64	100.64
2,690.000	100.64	100.64	100.64	100.64	100.63
2,695.000	100.63	100.63	100.63	100.63	100.63
2,700.000	100.63	100.63	100.63	100.63	100.63
2,705.000	100.63	100.62	100.62	100.62	100.62
2,710.000	100.62	100.62	100.62	100.62	100.62
2,715.000	100.62	100.62	100.62	100.61	100.61
2,720.000	100.61	100.61	100.61	100.61	100.61
2,725.000	100.61	100.61	100.61	100.61	100.60
2,730.000	100.60	100.60	100.60	100.60	100.60
2,735.000	100.60	100.60	100.60	100.60	100.60
2,740.000	100.60	100.59	100.59	100.59	100.59
2,745.000	100.59	100.59	100.59	100.59	100.59
2,750.000	100.59	100.59	100.59	100.58	100.58
2,755.000	100.58	100.58	100.58	100.58	100.58
2,760.000	100.58	100.58	100.58	100.58	100.58
2,765.000	100.57	100.57	100.57	100.57	100.57
2,770.000	100.57	100.57	100.57	100.57	100.57
2,775.000	100.57	100.57	100.56	100.56	100.56
2,780.000	100.56	100.56	100.56	100.56	100.56
2,785.000	100.56	100.56	100.56	100.56	100.55
2,790.000	100.55	100.55	100.55	100.55	100.55
2,795.000	100.55	100.55	100.55	100.55	100.55
2,800.000	100.54	100.54	100.54	100.54	100.54
2,805.000	100.54	100.54	100.54	100.54	100.54
2,810.000	100.54	100.54	100.53	100.53	100.53
2,815.000	100.53	100.53	100.53	100.53	100.53
2,820.000	100.53	100.53	100.53	100.53	100.52
2,825.000	100.52	100.52	100.52	100.52	100.52
2,830.000	100.52	100.52	100.52	100.52	100.52
2,835.000	100.52	100.51	100.51	100.51	100.51
2,840.000	100.51	100.51	100.51	100.51	100.51
2,845.000	100.51	100.51	100.51	100.51	100.50
2,850.000	100.50	100.50	100.50	100.50	100.50
2,855.000	100.50	100.50	100.50	100.50	100.50
2,860.000	100.50	100.49	100.49	100.49	100.49

## Detention Vault

Subsection: Time vs. Elevation  
 Label: 1 (OUT)  
 Scenario: EX10

Return Event: 100 years  
 Storm Event:

### Time vs. Elevation (ft)

**Output Time increment = 1.000 min**  
**Time on left represents time for first value in each row.**

Time (min)	Elevation (ft)	Elevation (ft)	Elevation (ft)	Elevation (ft)	Elevation (ft)
2,865.000	100.49	100.49	100.49	100.49	100.49
2,870.000	100.49	100.49	100.49	100.48	100.48
2,875.000	100.48	100.48	100.48	100.48	100.48
2,880.000	100.48	100.48	100.48	100.48	100.48
2,885.000	100.47	100.47	100.47	100.47	100.47
2,890.000	100.47	100.47	100.47	100.47	100.47
2,895.000	100.47	100.47	100.46	100.46	100.46
2,900.000	100.46	100.46	100.46	100.46	100.46
2,905.000	100.46	100.46	100.46	100.46	100.45
2,910.000	100.45	100.45	100.45	100.45	100.45
2,915.000	100.45	100.45	100.45	100.45	100.45
2,920.000	100.45	100.45	100.44	100.44	100.44
2,925.000	100.44	100.44	100.44	100.44	100.44
2,930.000	100.44	100.44	100.44	100.44	100.43
2,935.000	100.43	100.43	100.43	100.43	100.43
2,940.000	100.43	100.43	100.43	100.43	100.43
2,945.000	100.43	100.42	100.42	100.42	100.42
2,950.000	100.42	100.42	100.42	100.42	100.42
2,955.000	100.42	100.42	100.42	100.42	100.41
2,960.000	100.41	100.41	100.41	100.41	100.41
2,965.000	100.41	100.41	100.41	100.41	100.41
2,970.000	100.41	100.40	100.40	100.40	100.40
2,975.000	100.40	100.40	100.40	100.40	100.40
2,980.000	100.40	100.40	100.40	100.39	100.39
2,985.000	100.39	100.39	100.39	100.39	100.39
2,990.000	100.39	100.39	100.39	100.39	100.39
2,995.000	100.39	100.38	100.38	100.38	100.38
3,000.000	100.38	(N/A)	(N/A)	(N/A)	(N/A)

## Detention Vault

Subsection: Time vs. Volume  
 Label: 1  
 Scenario: EX10

Return Event: 100 years  
 Storm Event:

### Time vs. Volume (ac-ft)

**Output Time increment = 1.000 min**  
**Time on left represents time for first value in each row.**

Time (min)	Volume (ac-ft)	Volume (ac-ft)	Volume (ac-ft)	Volume (ac-ft)	Volume (ac-ft)
0.000	0.003	0.003	0.003	0.003	0.003
5.000	0.003	0.004	0.004	0.005	0.006
10.000	0.007	0.008	0.009	0.010	0.012
15.000	0.013	0.015	0.017	0.018	0.020
20.000	0.022	0.024	0.025	0.027	0.028
25.000	0.029	0.031	0.032	0.034	0.035
30.000	0.036	0.038	0.039	0.041	0.042
35.000	0.043	0.045	0.046	0.047	0.049
40.000	0.050	0.052	0.053	0.054	0.056
45.000	0.057	0.059	0.060	0.062	0.063
50.000	0.065	0.066	0.068	0.069	0.071
55.000	0.072	0.074	0.075	0.077	0.078
60.000	0.080	0.081	0.083	0.084	0.086
65.000	0.087	0.089	0.091	0.092	0.094
70.000	0.095	0.097	0.099	0.100	0.102
75.000	0.103	0.105	0.107	0.108	0.110
80.000	0.112	0.113	0.115	0.116	0.118
85.000	0.120	0.121	0.123	0.125	0.126
90.000	0.128	0.130	0.131	0.133	0.135
95.000	0.136	0.138	0.140	0.142	0.143
100.000	0.145	0.147	0.149	0.151	0.152
105.000	0.154	0.156	0.158	0.159	0.161
110.000	0.163	0.165	0.167	0.169	0.171
115.000	0.173	0.175	0.177	0.179	0.181
120.000	0.183	0.185	0.187	0.189	0.191
125.000	0.193	0.195	0.197	0.199	0.201
130.000	0.203	0.205	0.207	0.209	0.211
135.000	0.213	0.215	0.218	0.220	0.222
140.000	0.224	0.226	0.229	0.231	0.233
145.000	0.235	0.238	0.240	0.242	0.245
150.000	0.247	0.250	0.252	0.254	0.257
155.000	0.259	0.262	0.264	0.267	0.269
160.000	0.272	0.274	0.277	0.280	0.282
165.000	0.285	0.287	0.290	0.293	0.296
170.000	0.298	0.301	0.304	0.306	0.309
175.000	0.312	0.315	0.318	0.321	0.323
180.000	0.326	0.330	0.333	0.336	0.339
185.000	0.342	0.345	0.349	0.352	0.355
190.000	0.359	0.362	0.365	0.369	0.372
195.000	0.376	0.379	0.383	0.387	0.390

## Detention Vault

Subsection: Time vs. Volume  
 Label: 1  
 Scenario: EX10

Return Event: 100 years  
 Storm Event:

### Time vs. Volume (ac-ft)

**Output Time increment = 1.000 min**  
**Time on left represents time for first value in each row.**

Time (min)	Volume (ac-ft)	Volume (ac-ft)	Volume (ac-ft)	Volume (ac-ft)	Volume (ac-ft)
200.000	0.394	0.398	0.402	0.406	0.410
205.000	0.414	0.419	0.423	0.427	0.431
210.000	0.436	0.441	0.445	0.450	0.455
215.000	0.460	0.465	0.471	0.476	0.482
220.000	0.487	0.493	0.498	0.504	0.510
225.000	0.516	0.523	0.530	0.537	0.545
230.000	0.553	0.561	0.570	0.579	0.590
235.000	0.601	0.613	0.626	0.640	0.655
240.000	0.671	0.688	0.710	0.734	0.762
245.000	0.793	0.827	0.864	0.905	0.945
250.000	0.981	1.012	1.039	1.062	1.080
255.000	1.093	1.102	1.109	1.116	1.122
260.000	1.128	1.133	1.139	1.144	1.148
265.000	1.153	1.157	1.162	1.166	1.170
270.000	1.173	1.177	1.181	1.184	1.187
275.000	1.191	1.194	1.196	1.199	1.201
280.000	1.203	1.205	1.207	1.209	1.210
285.000	1.212	1.213	1.214	1.215	1.216
290.000	1.217	1.218	1.219	1.220	1.220
295.000	1.221	1.221	1.222	1.222	1.222
300.000	1.223	1.223	1.223	1.223	1.223
305.000	1.223	1.223	1.224	1.224	1.224
310.000	1.223	1.223	1.223	1.223	1.223
315.000	1.223	1.223	1.223	1.223	1.223
320.000	1.223	1.222	1.222	1.222	1.222
325.000	1.222	1.221	1.221	1.221	1.221
330.000	1.221	1.220	1.220	1.220	1.220
335.000	1.219	1.219	1.219	1.219	1.218
340.000	1.218	1.218	1.218	1.218	1.217
345.000	1.217	1.217	1.217	1.217	1.217
350.000	1.216	1.216	1.216	1.216	1.215
355.000	1.215	1.215	1.215	1.215	1.215
360.000	1.214	1.214	1.214	1.213	1.212
365.000	1.212	1.210	1.209	1.208	1.207
370.000	1.205	1.204	1.203	1.202	1.201
375.000	1.200	1.199	1.198	1.197	1.197
380.000	1.196	1.195	1.194	1.194	1.193
385.000	1.193	1.192	1.191	1.191	1.190
390.000	1.190	1.189	1.189	1.188	1.188
395.000	1.187	1.187	1.186	1.186	1.185
400.000	1.185	1.184	1.184	1.184	1.183

## Detention Vault

Subsection: Time vs. Volume  
 Label: 1  
 Scenario: EX10

Return Event: 100 years  
 Storm Event:

### Time vs. Volume (ac-ft)

**Output Time increment = 1.000 min**  
**Time on left represents time for first value in each row.**

Time (min)	Volume (ac-ft)	Volume (ac-ft)	Volume (ac-ft)	Volume (ac-ft)	Volume (ac-ft)
405.000	1.183	1.182	1.182	1.182	1.181
410.000	1.181	1.181	1.180	1.180	1.179
415.000	1.179	1.179	1.178	1.178	1.178
420.000	1.177	1.177	1.177	1.176	1.176
425.000	1.175	1.175	1.175	1.174	1.174
430.000	1.174	1.173	1.173	1.172	1.172
435.000	1.172	1.171	1.171	1.171	1.170
440.000	1.170	1.170	1.169	1.169	1.168
445.000	1.168	1.168	1.167	1.167	1.167
450.000	1.166	1.166	1.165	1.165	1.165
455.000	1.164	1.164	1.164	1.163	1.163
460.000	1.163	1.162	1.162	1.161	1.161
465.000	1.161	1.160	1.160	1.160	1.159
470.000	1.159	1.159	1.158	1.158	1.157
475.000	1.157	1.157	1.156	1.156	1.156
480.000	1.155	1.155	1.154	1.154	1.154
485.000	1.153	1.153	1.153	1.152	1.152
490.000	1.152	1.151	1.151	1.150	1.150
495.000	1.150	1.149	1.149	1.149	1.148
500.000	1.148	1.148	1.147	1.147	1.146
505.000	1.146	1.146	1.145	1.145	1.145
510.000	1.144	1.144	1.144	1.143	1.143
515.000	1.142	1.142	1.142	1.141	1.141
520.000	1.141	1.140	1.140	1.140	1.139
525.000	1.139	1.138	1.138	1.138	1.137
530.000	1.137	1.137	1.136	1.136	1.136
535.000	1.135	1.135	1.134	1.134	1.134
540.000	1.133	1.133	1.133	1.132	1.132
545.000	1.132	1.131	1.131	1.130	1.130
550.000	1.130	1.129	1.129	1.129	1.128
555.000	1.128	1.128	1.127	1.127	1.126
560.000	1.126	1.126	1.125	1.125	1.125
565.000	1.124	1.124	1.124	1.123	1.123
570.000	1.122	1.122	1.122	1.121	1.121
575.000	1.121	1.120	1.120	1.120	1.119
580.000	1.119	1.119	1.118	1.118	1.117
585.000	1.117	1.117	1.116	1.116	1.116
590.000	1.115	1.115	1.115	1.114	1.114
595.000	1.113	1.113	1.113	1.112	1.112
600.000	1.112	1.111	1.111	1.111	1.110
605.000	1.110	1.110	1.109	1.109	1.108

## Detention Vault

Subsection: Time vs. Volume  
 Label: 1  
 Scenario: EX10

Return Event: 100 years  
 Storm Event:

### Time vs. Volume (ac-ft)

**Output Time increment = 1.000 min**  
**Time on left represents time for first value in each row.**

Time (min)	Volume (ac-ft)	Volume (ac-ft)	Volume (ac-ft)	Volume (ac-ft)	Volume (ac-ft)
610.000	1.108	1.108	1.107	1.107	1.107
615.000	1.106	1.106	1.106	1.105	1.105
620.000	1.104	1.104	1.104	1.103	1.103
625.000	1.103	1.102	1.102	1.102	1.101
630.000	1.101	1.101	1.100	1.100	1.099
635.000	1.099	1.099	1.098	1.098	1.098
640.000	1.097	1.097	1.097	1.096	1.096
645.000	1.096	1.095	1.095	1.094	1.094
650.000	1.094	1.093	1.093	1.093	1.092
655.000	1.092	1.092	1.091	1.091	1.091
660.000	1.090	1.090	1.089	1.089	1.089
665.000	1.088	1.088	1.088	1.087	1.087
670.000	1.087	1.086	1.086	1.086	1.085
675.000	1.085	1.084	1.084	1.084	1.083
680.000	1.083	1.083	1.082	1.082	1.082
685.000	1.081	1.081	1.081	1.080	1.080
690.000	1.079	1.079	1.079	1.078	1.078
695.000	1.078	1.077	1.077	1.077	1.076
700.000	1.076	1.076	1.075	1.075	1.075
705.000	1.074	1.074	1.073	1.073	1.073
710.000	1.072	1.072	1.072	1.071	1.071
715.000	1.071	1.070	1.070	1.070	1.069
720.000	1.069	1.069	1.068	1.068	1.067
725.000	1.067	1.067	1.066	1.066	1.066
730.000	1.065	1.065	1.065	1.064	1.064
735.000	1.064	1.063	1.063	1.062	1.062
740.000	1.062	1.061	1.061	1.061	1.060
745.000	1.060	1.060	1.059	1.059	1.059
750.000	1.058	1.058	1.058	1.057	1.057
755.000	1.057	1.056	1.056	1.055	1.055
760.000	1.055	1.054	1.054	1.054	1.053
765.000	1.053	1.053	1.052	1.052	1.052
770.000	1.051	1.051	1.051	1.050	1.050
775.000	1.049	1.049	1.049	1.048	1.048
780.000	1.048	1.047	1.047	1.047	1.046
785.000	1.046	1.046	1.045	1.045	1.045
790.000	1.044	1.044	1.044	1.043	1.043
795.000	1.042	1.042	1.042	1.041	1.041
800.000	1.041	1.040	1.040	1.040	1.039
805.000	1.039	1.039	1.038	1.038	1.038
810.000	1.037	1.037	1.037	1.036	1.036

## Detention Vault

Subsection: Time vs. Volume  
 Label: 1  
 Scenario: EX10

Return Event: 100 years  
 Storm Event:

### Time vs. Volume (ac-ft)

**Output Time increment = 1.000 min**  
**Time on left represents time for first value in each row.**

Time (min)	Volume (ac-ft)	Volume (ac-ft)	Volume (ac-ft)	Volume (ac-ft)	Volume (ac-ft)
815.000	1.036	1.035	1.035	1.034	1.034
820.000	1.034	1.033	1.033	1.033	1.032
825.000	1.032	1.032	1.031	1.031	1.031
830.000	1.030	1.030	1.030	1.029	1.029
835.000	1.029	1.028	1.028	1.028	1.027
840.000	1.027	1.026	1.026	1.026	1.025
845.000	1.025	1.025	1.024	1.024	1.024
850.000	1.023	1.023	1.023	1.022	1.022
855.000	1.022	1.021	1.021	1.021	1.020
860.000	1.020	1.020	1.019	1.019	1.018
865.000	1.018	1.018	1.017	1.017	1.017
870.000	1.016	1.016	1.016	1.015	1.015
875.000	1.015	1.014	1.014	1.014	1.013
880.000	1.013	1.013	1.012	1.012	1.012
885.000	1.011	1.011	1.011	1.010	1.010
890.000	1.010	1.009	1.009	1.008	1.008
895.000	1.008	1.007	1.007	1.007	1.006
900.000	1.006	1.006	1.005	1.005	1.005
905.000	1.004	1.004	1.004	1.003	1.003
910.000	1.003	1.002	1.002	1.002	1.001
915.000	1.001	1.001	1.000	1.000	1.000
920.000	0.999	0.999	0.999	0.998	0.998
925.000	0.997	0.997	0.997	0.996	0.996
930.000	0.996	0.995	0.995	0.995	0.994
935.000	0.994	0.994	0.993	0.993	0.993
940.000	0.992	0.992	0.992	0.991	0.991
945.000	0.991	0.990	0.990	0.990	0.989
950.000	0.989	0.989	0.988	0.988	0.988
955.000	0.987	0.987	0.987	0.986	0.986
960.000	0.986	0.985	0.985	0.985	0.984
965.000	0.984	0.983	0.983	0.983	0.982
970.000	0.982	0.982	0.981	0.981	0.981
975.000	0.980	0.980	0.980	0.979	0.979
980.000	0.979	0.978	0.978	0.978	0.977
985.000	0.977	0.977	0.976	0.976	0.976
990.000	0.975	0.975	0.975	0.974	0.974
995.000	0.974	0.973	0.973	0.973	0.972
1,000.000	0.972	0.972	0.971	0.971	0.971
1,005.000	0.970	0.970	0.970	0.969	0.969
1,010.000	0.969	0.968	0.968	0.968	0.967
1,015.000	0.967	0.967	0.966	0.966	0.965



## Detention Vault

Subsection: Time vs. Volume  
 Label: 1  
 Scenario: EX10

Return Event: 100 years  
 Storm Event:

### Time vs. Volume (ac-ft)

**Output Time increment = 1.000 min**  
**Time on left represents time for first value in each row.**

Time (min)	Volume (ac-ft)	Volume (ac-ft)	Volume (ac-ft)	Volume (ac-ft)	Volume (ac-ft)
1,020.000	0.965	0.965	0.964	0.964	0.964
1,025.000	0.963	0.963	0.963	0.962	0.962
1,030.000	0.962	0.961	0.961	0.961	0.960
1,035.000	0.960	0.960	0.959	0.959	0.959
1,040.000	0.958	0.958	0.958	0.957	0.957
1,045.000	0.957	0.956	0.956	0.956	0.955
1,050.000	0.955	0.955	0.954	0.954	0.954
1,055.000	0.953	0.953	0.953	0.952	0.952
1,060.000	0.952	0.951	0.951	0.951	0.950
1,065.000	0.950	0.950	0.949	0.949	0.949
1,070.000	0.948	0.948	0.948	0.947	0.947
1,075.000	0.947	0.946	0.946	0.946	0.945
1,080.000	0.945	0.945	0.944	0.944	0.944
1,085.000	0.943	0.943	0.943	0.942	0.942
1,090.000	0.942	0.941	0.941	0.941	0.940
1,095.000	0.940	0.940	0.939	0.939	0.939
1,100.000	0.938	0.938	0.938	0.937	0.937
1,105.000	0.937	0.936	0.936	0.936	0.935
1,110.000	0.935	0.935	0.934	0.934	0.934
1,115.000	0.933	0.933	0.933	0.932	0.932
1,120.000	0.932	0.931	0.931	0.931	0.930
1,125.000	0.930	0.930	0.929	0.929	0.929
1,130.000	0.928	0.928	0.928	0.927	0.927
1,135.000	0.927	0.926	0.926	0.926	0.925
1,140.000	0.925	0.925	0.924	0.924	0.924
1,145.000	0.923	0.923	0.923	0.922	0.922
1,150.000	0.922	0.921	0.921	0.921	0.920
1,155.000	0.920	0.920	0.919	0.919	0.919
1,160.000	0.918	0.918	0.918	0.917	0.917
1,165.000	0.917	0.916	0.916	0.916	0.915
1,170.000	0.915	0.915	0.914	0.914	0.914
1,175.000	0.913	0.913	0.913	0.912	0.912
1,180.000	0.912	0.911	0.911	0.911	0.910
1,185.000	0.910	0.910	0.909	0.909	0.909
1,190.000	0.908	0.908	0.908	0.908	0.907
1,195.000	0.907	0.907	0.906	0.906	0.906
1,200.000	0.905	0.905	0.905	0.904	0.904
1,205.000	0.904	0.903	0.903	0.903	0.902
1,210.000	0.902	0.902	0.901	0.901	0.901
1,215.000	0.900	0.900	0.900	0.899	0.899
1,220.000	0.899	0.898	0.898	0.898	0.897

## Detention Vault

Subsection: Time vs. Volume  
 Label: 1  
 Scenario: EX10

Return Event: 100 years  
 Storm Event:

### Time vs. Volume (ac-ft)

**Output Time increment = 1.000 min**  
**Time on left represents time for first value in each row.**

Time (min)	Volume (ac-ft)	Volume (ac-ft)	Volume (ac-ft)	Volume (ac-ft)	Volume (ac-ft)
1,225.000	0.897	0.897	0.896	0.896	0.896
1,230.000	0.895	0.895	0.895	0.894	0.894
1,235.000	0.894	0.893	0.893	0.893	0.892
1,240.000	0.892	0.892	0.891	0.891	0.891
1,245.000	0.890	0.890	0.890	0.889	0.889
1,250.000	0.889	0.889	0.888	0.888	0.888
1,255.000	0.887	0.887	0.887	0.886	0.886
1,260.000	0.886	0.885	0.885	0.885	0.884
1,265.000	0.884	0.884	0.883	0.883	0.883
1,270.000	0.882	0.882	0.882	0.881	0.881
1,275.000	0.881	0.880	0.880	0.880	0.879
1,280.000	0.879	0.879	0.878	0.878	0.878
1,285.000	0.877	0.877	0.877	0.876	0.876
1,290.000	0.876	0.876	0.875	0.875	0.875
1,295.000	0.874	0.874	0.874	0.873	0.873
1,300.000	0.873	0.872	0.872	0.872	0.871
1,305.000	0.871	0.871	0.870	0.870	0.870
1,310.000	0.869	0.869	0.869	0.868	0.868
1,315.000	0.868	0.867	0.867	0.867	0.866
1,320.000	0.866	0.866	0.866	0.865	0.865
1,325.000	0.865	0.864	0.864	0.864	0.863
1,330.000	0.863	0.863	0.862	0.862	0.862
1,335.000	0.861	0.861	0.861	0.860	0.860
1,340.000	0.860	0.859	0.859	0.859	0.858
1,345.000	0.858	0.858	0.857	0.857	0.857
1,350.000	0.857	0.856	0.856	0.856	0.855
1,355.000	0.855	0.855	0.854	0.854	0.854
1,360.000	0.853	0.853	0.853	0.852	0.852
1,365.000	0.852	0.851	0.851	0.851	0.850
1,370.000	0.850	0.850	0.849	0.849	0.849
1,375.000	0.849	0.848	0.848	0.848	0.847
1,380.000	0.847	0.847	0.846	0.846	0.846
1,385.000	0.845	0.845	0.845	0.844	0.844
1,390.000	0.844	0.843	0.843	0.843	0.842
1,395.000	0.842	0.842	0.842	0.841	0.841
1,400.000	0.841	0.840	0.840	0.840	0.839
1,405.000	0.839	0.839	0.838	0.838	0.838
1,410.000	0.837	0.837	0.837	0.836	0.836
1,415.000	0.836	0.835	0.835	0.835	0.835
1,420.000	0.834	0.834	0.834	0.833	0.833
1,425.000	0.833	0.832	0.832	0.832	0.831

## Detention Vault

Subsection: Time vs. Volume  
 Label: 1  
 Scenario: EX10

Return Event: 100 years  
 Storm Event:

### Time vs. Volume (ac-ft)

**Output Time increment = 1.000 min**  
**Time on left represents time for first value in each row.**

Time (min)	Volume (ac-ft)	Volume (ac-ft)	Volume (ac-ft)	Volume (ac-ft)	Volume (ac-ft)
1,430.000	0.831	0.831	0.830	0.830	0.830
1,435.000	0.829	0.829	0.829	0.829	0.828
1,440.000	0.828	0.828	0.827	0.827	0.827
1,445.000	0.826	0.826	0.826	0.825	0.825
1,450.000	0.825	0.824	0.824	0.824	0.823
1,455.000	0.823	0.823	0.823	0.822	0.822
1,460.000	0.822	0.821	0.821	0.821	0.820
1,465.000	0.820	0.820	0.819	0.819	0.819
1,470.000	0.818	0.818	0.818	0.817	0.817
1,475.000	0.817	0.817	0.816	0.816	0.816
1,480.000	0.815	0.815	0.815	0.814	0.814
1,485.000	0.814	0.813	0.813	0.813	0.812
1,490.000	0.812	0.812	0.812	0.811	0.811
1,495.000	0.811	0.810	0.810	0.810	0.809
1,500.000	0.809	0.809	0.808	0.808	0.808
1,505.000	0.807	0.807	0.807	0.807	0.806
1,510.000	0.806	0.806	0.805	0.805	0.805
1,515.000	0.804	0.804	0.804	0.803	0.803
1,520.000	0.803	0.802	0.802	0.802	0.802
1,525.000	0.801	0.801	0.801	0.800	0.800
1,530.000	0.800	0.799	0.799	0.799	0.798
1,535.000	0.798	0.798	0.797	0.797	0.797
1,540.000	0.797	0.796	0.796	0.796	0.795
1,545.000	0.795	0.795	0.794	0.794	0.794
1,550.000	0.793	0.793	0.793	0.793	0.792
1,555.000	0.792	0.792	0.791	0.791	0.791
1,560.000	0.790	0.790	0.790	0.789	0.789
1,565.000	0.789	0.789	0.788	0.788	0.788
1,570.000	0.787	0.787	0.787	0.786	0.786
1,575.000	0.786	0.785	0.785	0.785	0.785
1,580.000	0.784	0.784	0.784	0.783	0.783
1,585.000	0.783	0.782	0.782	0.782	0.781
1,590.000	0.781	0.781	0.780	0.780	0.780
1,595.000	0.780	0.779	0.779	0.779	0.778
1,600.000	0.778	0.778	0.777	0.777	0.777
1,605.000	0.776	0.776	0.776	0.776	0.775
1,610.000	0.775	0.775	0.774	0.774	0.774
1,615.000	0.773	0.773	0.773	0.772	0.772
1,620.000	0.772	0.772	0.771	0.771	0.771
1,625.000	0.770	0.770	0.770	0.769	0.769
1,630.000	0.769	0.769	0.768	0.768	0.768

## Detention Vault

Subsection: Time vs. Volume  
 Label: 1  
 Scenario: EX10

Return Event: 100 years  
 Storm Event:

### Time vs. Volume (ac-ft)

**Output Time increment = 1.000 min**  
**Time on left represents time for first value in each row.**

Time (min)	Volume (ac-ft)	Volume (ac-ft)	Volume (ac-ft)	Volume (ac-ft)	Volume (ac-ft)
1,635.000	0.767	0.767	0.767	0.766	0.766
1,640.000	0.766	0.765	0.765	0.765	0.765
1,645.000	0.764	0.764	0.764	0.763	0.763
1,650.000	0.763	0.762	0.762	0.762	0.762
1,655.000	0.761	0.761	0.761	0.760	0.760
1,660.000	0.760	0.759	0.759	0.759	0.758
1,665.000	0.758	0.758	0.758	0.757	0.757
1,670.000	0.757	0.756	0.756	0.756	0.755
1,675.000	0.755	0.755	0.755	0.754	0.754
1,680.000	0.754	0.753	0.753	0.753	0.752
1,685.000	0.752	0.752	0.751	0.751	0.751
1,690.000	0.751	0.750	0.750	0.750	0.749
1,695.000	0.749	0.749	0.748	0.748	0.748
1,700.000	0.748	0.747	0.747	0.747	0.746
1,705.000	0.746	0.746	0.745	0.745	0.745
1,710.000	0.745	0.744	0.744	0.744	0.743
1,715.000	0.743	0.743	0.742	0.742	0.742
1,720.000	0.742	0.741	0.741	0.741	0.740
1,725.000	0.740	0.740	0.739	0.739	0.739
1,730.000	0.738	0.738	0.738	0.738	0.737
1,735.000	0.737	0.737	0.736	0.736	0.736
1,740.000	0.736	0.735	0.735	0.735	0.734
1,745.000	0.734	0.734	0.733	0.733	0.733
1,750.000	0.733	0.732	0.732	0.732	0.731
1,755.000	0.731	0.731	0.730	0.730	0.730
1,760.000	0.730	0.729	0.729	0.729	0.728
1,765.000	0.728	0.728	0.727	0.727	0.727
1,770.000	0.727	0.726	0.726	0.726	0.725
1,775.000	0.725	0.725	0.724	0.724	0.724
1,780.000	0.724	0.723	0.723	0.723	0.722
1,785.000	0.722	0.722	0.721	0.721	0.721
1,790.000	0.721	0.720	0.720	0.720	0.719
1,795.000	0.719	0.719	0.718	0.718	0.718
1,800.000	0.718	0.717	0.717	0.717	0.716
1,805.000	0.716	0.716	0.716	0.715	0.715
1,810.000	0.715	0.714	0.714	0.714	0.713
1,815.000	0.713	0.713	0.713	0.712	0.712
1,820.000	0.712	0.711	0.711	0.711	0.710
1,825.000	0.710	0.710	0.710	0.709	0.709
1,830.000	0.709	0.708	0.708	0.708	0.708
1,835.000	0.707	0.707	0.707	0.706	0.706

## Detention Vault

Subsection: Time vs. Volume  
 Label: 1  
 Scenario: EX10

Return Event: 100 years  
 Storm Event:

### Time vs. Volume (ac-ft)

**Output Time increment = 1.000 min**  
**Time on left represents time for first value in each row.**

Time (min)	Volume (ac-ft)	Volume (ac-ft)	Volume (ac-ft)	Volume (ac-ft)	Volume (ac-ft)
1,840.000	0.706	0.705	0.705	0.705	0.705
1,845.000	0.704	0.704	0.704	0.703	0.703
1,850.000	0.703	0.703	0.702	0.702	0.702
1,855.000	0.701	0.701	0.701	0.700	0.700
1,860.000	0.700	0.700	0.699	0.699	0.699
1,865.000	0.698	0.698	0.698	0.698	0.697
1,870.000	0.697	0.697	0.696	0.696	0.696
1,875.000	0.695	0.695	0.695	0.695	0.694
1,880.000	0.694	0.694	0.693	0.693	0.693
1,885.000	0.693	0.692	0.692	0.692	0.691
1,890.000	0.691	0.691	0.690	0.690	0.690
1,895.000	0.690	0.689	0.689	0.689	0.688
1,900.000	0.688	0.688	0.688	0.687	0.687
1,905.000	0.687	0.686	0.686	0.686	0.686
1,910.000	0.685	0.685	0.685	0.684	0.684
1,915.000	0.684	0.683	0.683	0.683	0.683
1,920.000	0.682	0.682	0.682	0.681	0.681
1,925.000	0.681	0.681	0.680	0.680	0.680
1,930.000	0.679	0.679	0.679	0.679	0.678
1,935.000	0.678	0.678	0.677	0.677	0.677
1,940.000	0.677	0.676	0.676	0.676	0.675
1,945.000	0.675	0.675	0.674	0.674	0.674
1,950.000	0.674	0.673	0.673	0.673	0.672
1,955.000	0.672	0.672	0.672	0.671	0.671
1,960.000	0.671	0.670	0.670	0.670	0.670
1,965.000	0.669	0.669	0.669	0.668	0.668
1,970.000	0.668	0.668	0.667	0.667	0.667
1,975.000	0.666	0.666	0.666	0.666	0.665
1,980.000	0.665	0.665	0.664	0.664	0.664
1,985.000	0.664	0.663	0.663	0.663	0.662
1,990.000	0.662	0.662	0.662	0.661	0.661
1,995.000	0.661	0.660	0.660	0.660	0.660
2,000.000	0.659	0.659	0.659	0.658	0.658
2,005.000	0.658	0.658	0.657	0.657	0.657
2,010.000	0.656	0.656	0.656	0.656	0.655
2,015.000	0.655	0.655	0.654	0.654	0.654
2,020.000	0.654	0.653	0.653	0.653	0.652
2,025.000	0.652	0.652	0.652	0.651	0.651
2,030.000	0.651	0.650	0.650	0.650	0.650
2,035.000	0.649	0.649	0.649	0.648	0.648
2,040.000	0.648	0.648	0.647	0.647	0.647

## Detention Vault

Subsection: Time vs. Volume  
 Label: 1  
 Scenario: EX10

Return Event: 100 years  
 Storm Event:

### Time vs. Volume (ac-ft)

**Output Time increment = 1.000 min**  
**Time on left represents time for first value in each row.**

Time (min)	Volume (ac-ft)	Volume (ac-ft)	Volume (ac-ft)	Volume (ac-ft)	Volume (ac-ft)
2,045.000	0.646	0.646	0.646	0.646	0.645
2,050.000	0.645	0.645	0.644	0.644	0.644
2,055.000	0.644	0.643	0.643	0.643	0.642
2,060.000	0.642	0.642	0.642	0.641	0.641
2,065.000	0.641	0.640	0.640	0.640	0.640
2,070.000	0.639	0.639	0.639	0.638	0.638
2,075.000	0.638	0.638	0.637	0.637	0.637
2,080.000	0.637	0.636	0.636	0.636	0.635
2,085.000	0.635	0.635	0.635	0.634	0.634
2,090.000	0.634	0.633	0.633	0.633	0.633
2,095.000	0.632	0.632	0.632	0.631	0.631
2,100.000	0.631	0.631	0.630	0.630	0.630
2,105.000	0.629	0.629	0.629	0.629	0.628
2,110.000	0.628	0.628	0.628	0.627	0.627
2,115.000	0.627	0.626	0.626	0.626	0.626
2,120.000	0.625	0.625	0.625	0.624	0.624
2,125.000	0.624	0.624	0.623	0.623	0.623
2,130.000	0.622	0.622	0.622	0.622	0.621
2,135.000	0.621	0.621	0.621	0.620	0.620
2,140.000	0.620	0.619	0.619	0.619	0.619
2,145.000	0.618	0.618	0.618	0.617	0.617
2,150.000	0.617	0.617	0.616	0.616	0.616
2,155.000	0.615	0.615	0.615	0.615	0.614
2,160.000	0.614	0.614	0.614	0.613	0.613
2,165.000	0.613	0.612	0.612	0.612	0.612
2,170.000	0.611	0.611	0.611	0.610	0.610
2,175.000	0.610	0.610	0.609	0.609	0.609
2,180.000	0.609	0.608	0.608	0.608	0.607
2,185.000	0.607	0.607	0.607	0.606	0.606
2,190.000	0.606	0.605	0.605	0.605	0.605
2,195.000	0.604	0.604	0.604	0.604	0.603
2,200.000	0.603	0.603	0.602	0.602	0.602
2,205.000	0.602	0.601	0.601	0.601	0.601
2,210.000	0.600	0.600	0.600	0.599	0.599
2,215.000	0.599	0.599	0.598	0.598	0.598
2,220.000	0.597	0.597	0.597	0.597	0.596
2,225.000	0.596	0.596	0.596	0.595	0.595
2,230.000	0.595	0.594	0.594	0.594	0.594
2,235.000	0.593	0.593	0.593	0.593	0.592
2,240.000	0.592	0.592	0.591	0.591	0.591
2,245.000	0.591	0.590	0.590	0.590	0.590

## Detention Vault

Subsection: Time vs. Volume  
 Label: 1  
 Scenario: EX10

Return Event: 100 years  
 Storm Event:

### Time vs. Volume (ac-ft)

**Output Time increment = 1.000 min**  
**Time on left represents time for first value in each row.**

Time (min)	Volume (ac-ft)	Volume (ac-ft)	Volume (ac-ft)	Volume (ac-ft)	Volume (ac-ft)
2,250.000	0.589	0.589	0.589	0.588	0.588
2,255.000	0.588	0.588	0.587	0.587	0.587
2,260.000	0.587	0.586	0.586	0.586	0.585
2,265.000	0.585	0.585	0.585	0.584	0.584
2,270.000	0.584	0.584	0.583	0.583	0.583
2,275.000	0.582	0.582	0.582	0.582	0.581
2,280.000	0.581	0.581	0.581	0.580	0.580
2,285.000	0.580	0.579	0.579	0.579	0.579
2,290.000	0.578	0.578	0.578	0.578	0.577
2,295.000	0.577	0.577	0.576	0.576	0.576
2,300.000	0.576	0.575	0.575	0.575	0.575
2,305.000	0.574	0.574	0.574	0.574	0.573
2,310.000	0.573	0.573	0.572	0.572	0.572
2,315.000	0.572	0.571	0.571	0.571	0.571
2,320.000	0.570	0.570	0.570	0.569	0.569
2,325.000	0.569	0.569	0.568	0.568	0.568
2,330.000	0.568	0.567	0.567	0.567	0.566
2,335.000	0.566	0.566	0.566	0.565	0.565
2,340.000	0.565	0.565	0.564	0.564	0.564
2,345.000	0.564	0.563	0.563	0.563	0.562
2,350.000	0.562	0.562	0.562	0.561	0.561
2,355.000	0.561	0.561	0.560	0.560	0.560
2,360.000	0.560	0.559	0.559	0.559	0.558
2,365.000	0.558	0.558	0.558	0.557	0.557
2,370.000	0.557	0.557	0.556	0.556	0.556
2,375.000	0.556	0.555	0.555	0.555	0.554
2,380.000	0.554	0.554	0.554	0.553	0.553
2,385.000	0.553	0.553	0.552	0.552	0.552
2,390.000	0.552	0.551	0.551	0.551	0.550
2,395.000	0.550	0.550	0.550	0.549	0.549
2,400.000	0.549	0.549	0.548	0.548	0.548
2,405.000	0.548	0.547	0.547	0.547	0.546
2,410.000	0.546	0.546	0.546	0.545	0.545
2,415.000	0.545	0.545	0.544	0.544	0.544
2,420.000	0.544	0.543	0.543	0.543	0.542
2,425.000	0.542	0.542	0.542	0.541	0.541
2,430.000	0.541	0.541	0.540	0.540	0.540
2,435.000	0.540	0.539	0.539	0.539	0.539
2,440.000	0.538	0.538	0.538	0.537	0.537
2,445.000	0.537	0.537	0.536	0.536	0.536
2,450.000	0.536	0.535	0.535	0.535	0.535

## Detention Vault

Subsection: Time vs. Volume  
 Label: 1  
 Scenario: EX10

Return Event: 100 years  
 Storm Event:

### Time vs. Volume (ac-ft)

**Output Time increment = 1.000 min**  
**Time on left represents time for first value in each row.**

Time (min)	Volume (ac-ft)	Volume (ac-ft)	Volume (ac-ft)	Volume (ac-ft)	Volume (ac-ft)
2,455.000	0.534	0.534	0.534	0.534	0.533
2,460.000	0.533	0.533	0.532	0.532	0.532
2,465.000	0.532	0.531	0.531	0.531	0.531
2,470.000	0.530	0.530	0.530	0.530	0.529
2,475.000	0.529	0.529	0.529	0.528	0.528
2,480.000	0.528	0.528	0.527	0.527	0.527
2,485.000	0.526	0.526	0.526	0.526	0.525
2,490.000	0.525	0.525	0.525	0.524	0.524
2,495.000	0.524	0.524	0.523	0.523	0.523
2,500.000	0.523	0.522	0.522	0.522	0.522
2,505.000	0.521	0.521	0.521	0.520	0.520
2,510.000	0.520	0.520	0.519	0.519	0.519
2,515.000	0.519	0.518	0.518	0.518	0.518
2,520.000	0.517	0.517	0.517	0.517	0.516
2,525.000	0.516	0.516	0.516	0.515	0.515
2,530.000	0.515	0.515	0.514	0.514	0.514
2,535.000	0.513	0.513	0.513	0.513	0.512
2,540.000	0.512	0.512	0.512	0.511	0.511
2,545.000	0.511	0.511	0.510	0.510	0.510
2,550.000	0.510	0.509	0.509	0.509	0.509
2,555.000	0.508	0.508	0.508	0.508	0.507
2,560.000	0.507	0.507	0.507	0.506	0.506
2,565.000	0.506	0.505	0.505	0.505	0.505
2,570.000	0.504	0.504	0.504	0.504	0.503
2,575.000	0.503	0.503	0.503	0.502	0.502
2,580.000	0.502	0.502	0.501	0.501	0.501
2,585.000	0.501	0.500	0.500	0.500	0.500
2,590.000	0.499	0.499	0.499	0.499	0.498
2,595.000	0.498	0.498	0.498	0.497	0.497
2,600.000	0.497	0.497	0.496	0.496	0.496
2,605.000	0.496	0.495	0.495	0.495	0.494
2,610.000	0.494	0.494	0.494	0.493	0.493
2,615.000	0.493	0.493	0.492	0.492	0.492
2,620.000	0.492	0.491	0.491	0.491	0.491
2,625.000	0.490	0.490	0.490	0.490	0.489
2,630.000	0.489	0.489	0.489	0.488	0.488
2,635.000	0.488	0.488	0.487	0.487	0.487
2,640.000	0.487	0.486	0.486	0.486	0.486
2,645.000	0.485	0.485	0.485	0.485	0.484
2,650.000	0.484	0.484	0.484	0.483	0.483
2,655.000	0.483	0.483	0.482	0.482	0.482



## Detention Vault

Subsection: Time vs. Volume  
 Label: 1  
 Scenario: EX10

Return Event: 100 years  
 Storm Event:

### Time vs. Volume (ac-ft)

**Output Time increment = 1.000 min**  
**Time on left represents time for first value in each row.**

Time (min)	Volume (ac-ft)	Volume (ac-ft)	Volume (ac-ft)	Volume (ac-ft)	Volume (ac-ft)
2,660.000	0.482	0.481	0.481	0.481	0.481
2,665.000	0.480	0.480	0.480	0.480	0.479
2,670.000	0.479	0.479	0.479	0.478	0.478
2,675.000	0.478	0.478	0.477	0.477	0.477
2,680.000	0.477	0.476	0.476	0.476	0.476
2,685.000	0.475	0.475	0.475	0.475	0.474
2,690.000	0.474	0.474	0.474	0.473	0.473
2,695.000	0.473	0.473	0.472	0.472	0.472
2,700.000	0.472	0.471	0.471	0.471	0.471
2,705.000	0.470	0.470	0.470	0.470	0.469
2,710.000	0.469	0.469	0.469	0.468	0.468
2,715.000	0.468	0.468	0.467	0.467	0.467
2,720.000	0.467	0.466	0.466	0.466	0.466
2,725.000	0.465	0.465	0.465	0.465	0.464
2,730.000	0.464	0.464	0.464	0.463	0.463
2,735.000	0.463	0.463	0.462	0.462	0.462
2,740.000	0.462	0.461	0.461	0.461	0.461
2,745.000	0.460	0.460	0.460	0.460	0.459
2,750.000	0.459	0.459	0.459	0.458	0.458
2,755.000	0.458	0.458	0.457	0.457	0.457
2,760.000	0.457	0.456	0.456	0.456	0.456
2,765.000	0.455	0.455	0.455	0.455	0.454
2,770.000	0.454	0.454	0.454	0.453	0.453
2,775.000	0.453	0.453	0.452	0.452	0.452
2,780.000	0.452	0.451	0.451	0.451	0.451
2,785.000	0.451	0.450	0.450	0.450	0.450
2,790.000	0.449	0.449	0.449	0.449	0.448
2,795.000	0.448	0.448	0.448	0.447	0.447
2,800.000	0.447	0.447	0.446	0.446	0.446
2,805.000	0.446	0.445	0.445	0.445	0.445
2,810.000	0.444	0.444	0.444	0.444	0.443
2,815.000	0.443	0.443	0.443	0.442	0.442
2,820.000	0.442	0.442	0.441	0.441	0.441
2,825.000	0.441	0.440	0.440	0.440	0.440
2,830.000	0.440	0.439	0.439	0.439	0.439
2,835.000	0.438	0.438	0.438	0.438	0.437
2,840.000	0.437	0.437	0.437	0.436	0.436
2,845.000	0.436	0.436	0.435	0.435	0.435
2,850.000	0.435	0.434	0.434	0.434	0.434
2,855.000	0.433	0.433	0.433	0.433	0.432
2,860.000	0.432	0.432	0.432	0.432	0.431

## Detention Vault

Subsection: Time vs. Volume  
 Label: 1  
 Scenario: EX10

Return Event: 100 years  
 Storm Event:

### Time vs. Volume (ac-ft)

**Output Time increment = 1.000 min**  
**Time on left represents time for first value in each row.**

Time (min)	Volume (ac-ft)	Volume (ac-ft)	Volume (ac-ft)	Volume (ac-ft)	Volume (ac-ft)
2,865.000	0.431	0.431	0.431	0.430	0.430
2,870.000	0.430	0.430	0.429	0.429	0.429
2,875.000	0.429	0.428	0.428	0.428	0.428
2,880.000	0.427	0.427	0.427	0.427	0.426
2,885.000	0.426	0.426	0.426	0.426	0.425
2,890.000	0.425	0.425	0.425	0.424	0.424
2,895.000	0.424	0.424	0.423	0.423	0.423
2,900.000	0.423	0.422	0.422	0.422	0.422
2,905.000	0.421	0.421	0.421	0.421	0.420
2,910.000	0.420	0.420	0.420	0.420	0.419
2,915.000	0.419	0.419	0.419	0.418	0.418
2,920.000	0.418	0.418	0.417	0.417	0.417
2,925.000	0.417	0.416	0.416	0.416	0.416
2,930.000	0.415	0.415	0.415	0.415	0.415
2,935.000	0.414	0.414	0.414	0.414	0.413
2,940.000	0.413	0.413	0.413	0.412	0.412
2,945.000	0.412	0.412	0.411	0.411	0.411
2,950.000	0.411	0.410	0.410	0.410	0.410
2,955.000	0.410	0.409	0.409	0.409	0.409
2,960.000	0.408	0.408	0.408	0.408	0.407
2,965.000	0.407	0.407	0.407	0.406	0.406
2,970.000	0.406	0.406	0.406	0.405	0.405
2,975.000	0.405	0.405	0.404	0.404	0.404
2,980.000	0.404	0.403	0.403	0.403	0.403
2,985.000	0.402	0.402	0.402	0.402	0.402
2,990.000	0.401	0.401	0.401	0.401	0.400
2,995.000	0.400	0.400	0.400	0.399	0.399
3,000.000	0.399	(N/A)	(N/A)	(N/A)	(N/A)

## Detention Vault

Subsection: Elevation-Area Volume Curve

Return Event: 100 years

Label: 1

Storm Event:

Scenario: EX10

Elevation (ft)	Planimeter (ft <sup>2</sup> )	Area (ft <sup>2</sup> )	A1+A2+sqr (A1*A2) (ft <sup>2</sup> )	Volume (ac-ft)	Volume (Total) (ac-ft)
98.50	0.0	160.000	0.000	0.000	0.000
98.96	0.0	160.000	480.000	0.002	0.002
99.06	0.0	12,736.000	14,323.501	0.011	0.013
104.06	0.0	12,736.000	38,208.000	1.462	1.475

## Detention Vault

Subsection: Volume Equations

Label: 1

Scenario: EX10

Return Event: 100 years

Storm Event:

### Pond Volume Equations

**\* Incremental volume computed by the Conic Method for Reservoir Volumes.**

$$\text{Volume} = (1/3) * (\text{EL2} - \text{EL1}) * (\text{Area1} + \text{Area2} + \text{sqr}(\text{Area1} * \text{Area2}))$$

where:	EL1, EL2	Lower and upper elevations of the increment
	Area1, Area2	Areas computed for EL1, EL2, respectively
	Volume	Incremental volume between EL1 and EL2

## Detention Vault

Subsection: Outlet Input Data

Label: Outlet#1

Scenario: EX10

Return Event: 100 years

Storm Event:

---

### Requested Pond Water Surface Elevations

---

Minimum (Headwater)	98.50 ft
Increment (Headwater)	0.10 ft
Maximum (Headwater)	104.06 ft

---

### Outlet Connectivity

Structure Type	Outlet ID	Direction	Outfall	E1 (ft)	E2 (ft)
Orifice-Circular	Orifice - MWS	Forward	TW	98.50	104.06
Culvert-Circular	Culvert - 1	Forward	Weir - 1	98.50	104.06
Rectangular Weir	Weir - 1	Forward	TW	103.06	104.06
Tailwater Settings	Tailwater			(N/A)	(N/A)

## Detention Vault

Subsection: Outlet Input Data

Label: Outlet#1

Scenario: EX10

Return Event: 100 years

Storm Event:

---

Structure ID: Orifice - MWS	
Structure Type: Orifice-Circular	
<hr/>	
Number of Openings	1
Elevation	98.50 ft
Orifice Diameter	2.2 in
Orifice Coefficient	0.600

---

## Detention Vault

Subsection: Outlet Input Data

Label: Outlet#1

Scenario: EX10

Return Event: 100 years

Storm Event:

Structure ID: Culvert - 1	
Structure Type: Culvert-Circular	
Number of Barrels	1
Diameter	24.0 in
Length	15.00 ft
Length (Computed Barrel)	15.01 ft
Slope (Computed)	0.033 ft/ft
<b>Outlet Control Data</b>	
Manning's n	0.013
Ke	0.500
Kb	0.012
Kr	0.500
Convergence Tolerance	0.00 ft
<b>Inlet Control Data</b>	
Equation Form	Form 1
K	0.0098
M	2.0000
C	0.0398
Y	0.6700
T1 ratio (HW/D)	0.000
T2 ratio (HW/D)	1.290
Slope Correction Factor	-0.500

Use unsubmerged inlet control 0 equation below T1 elevation.

Use submerged inlet control 0 equation above T2 elevation

In transition zone between unsubmerged and submerged inlet control, interpolate between flows at T1 & T2...

T1 Elevation	98.50 ft	T1 Flow	15.55 ft <sup>3</sup> /s
T2 Elevation	101.08 ft	T2 Flow	17.77 ft <sup>3</sup> /s

## Detention Vault

Subsection: Outlet Input Data

Label: Outlet#1

Scenario: EX10

Return Event: 100 years

Storm Event:

---

Structure ID: Weir - 1	
Structure Type: Rectangular Weir	
Number of Openings	1
Elevation	103.06 ft
Weir Length	8.00 ft
Weir Coefficient	3.00 (ft <sup>0.5</sup> )/s

---

---

Structure ID: TW	
Structure Type: TW Setup, DS Channel	
Tailwater Type	Free Outfall

---

---

Convergence Tolerances	
Maximum Iterations	30
Tailwater Tolerance (Minimum)	0.01 ft
Tailwater Tolerance (Maximum)	0.50 ft
Headwater Tolerance (Minimum)	0.01 ft
Headwater Tolerance (Maximum)	0.50 ft
Flow Tolerance (Minimum)	0.001 ft <sup>3</sup> /s
Flow Tolerance (Maximum)	10.000 ft <sup>3</sup> /s

---



## Detention Vault

Subsection: Elevation-Volume-Flow Table (Pond)

Return Event: 100 years

Label: 1

Storm Event:

Scenario: EX10

Infiltration	
Infiltration Method (Computed)	No Infiltration
Initial Conditions	
Elevation (Water Surface, Initial)	99.00 ft
Volume (Initial)	0.003 ac-ft
Flow (Initial Outlet)	0.08 ft <sup>3</sup> /s
Flow (Initial Infiltration)	0.00 ft <sup>3</sup> /s
Flow (Initial, Total)	0.08 ft <sup>3</sup> /s
Time Increment	1.000 min

Elevation (ft)	Outflow (ft <sup>3</sup> /s)	Storage (ac-ft)	Area (ft <sup>2</sup> )	Infiltration (ft <sup>3</sup> /s)	Flow (Total) (ft <sup>3</sup> /s)	2S/t + O (ft <sup>3</sup> /s)
98.50	0.00	0.000	160.000	0.00	0.00	0.00
98.60	0.01	0.000	160.000	0.00	0.01	0.55
98.70	0.04	0.001	160.000	0.00	0.04	1.11
98.80	0.06	0.001	160.000	0.00	0.06	1.66
98.90	0.07	0.001	160.000	0.00	0.07	2.20
99.00	0.08	0.003	2,780.561	0.00	0.08	4.14
99.10	0.09	0.024	12,736.000	0.00	0.09	35.44
99.20	0.10	0.054	12,736.000	0.00	0.10	77.90
99.30	0.11	0.083	12,736.000	0.00	0.11	120.36
99.40	0.11	0.112	12,736.000	0.00	0.11	162.82
99.50	0.12	0.141	12,736.000	0.00	0.12	205.28
99.60	0.13	0.171	12,736.000	0.00	0.13	247.74
99.70	0.13	0.200	12,736.000	0.00	0.13	290.20
99.80	0.14	0.229	12,736.000	0.00	0.14	332.66
99.90	0.15	0.258	12,736.000	0.00	0.15	375.12
100.00	0.15	0.287	12,736.000	0.00	0.15	417.58
100.10	0.16	0.317	12,736.000	0.00	0.16	460.04
100.20	0.16	0.346	12,736.000	0.00	0.16	502.50
100.30	0.17	0.375	12,736.000	0.00	0.17	544.96
100.40	0.17	0.404	12,736.000	0.00	0.17	587.41
100.50	0.18	0.434	12,736.000	0.00	0.18	629.87
100.60	0.18	0.463	12,736.000	0.00	0.18	672.33
100.70	0.18	0.492	12,736.000	0.00	0.18	714.79
100.80	0.19	0.521	12,736.000	0.00	0.19	757.25
100.90	0.19	0.551	12,736.000	0.00	0.19	799.70
101.00	0.20	0.580	12,736.000	0.00	0.20	842.16
101.10	0.20	0.609	12,736.000	0.00	0.20	884.62
101.20	0.21	0.638	12,736.000	0.00	0.21	927.07
101.30	0.21	0.668	12,736.000	0.00	0.21	969.53

## Detention Vault

Subsection: Elevation-Volume-Flow Table (Pond)

Return Event: 100 years

Label: 1

Storm Event:

Scenario: EX10

Elevation (ft)	Outflow (ft <sup>3</sup> /s)	Storage (ac-ft)	Area (ft <sup>2</sup> )	Infiltration (ft <sup>3</sup> /s)	Flow (Total) (ft <sup>3</sup> /s)	2S/t + O (ft <sup>3</sup> /s)
101.40	0.21	0.697	12,736.000	0.00	0.21	1,011.99
101.50	0.22	0.726	12,736.000	0.00	0.22	1,054.45
101.60	0.22	0.755	12,736.000	0.00	0.22	1,096.90
101.70	0.22	0.785	12,736.000	0.00	0.22	1,139.36
101.80	0.23	0.814	12,736.000	0.00	0.23	1,181.82
101.90	0.23	0.843	12,736.000	0.00	0.23	1,224.27
102.00	0.23	0.872	12,736.000	0.00	0.23	1,266.73
102.10	0.24	0.901	12,736.000	0.00	0.24	1,309.19
102.20	0.24	0.931	12,736.000	0.00	0.24	1,351.64
102.30	0.24	0.960	12,736.000	0.00	0.24	1,394.10
102.40	0.25	0.989	12,736.000	0.00	0.25	1,436.56
102.50	0.25	1.018	12,736.000	0.00	0.25	1,479.01
102.60	0.25	1.048	12,736.000	0.00	0.25	1,521.47
102.70	0.26	1.077	12,736.000	0.00	0.26	1,563.93
102.80	0.26	1.106	12,736.000	0.00	0.26	1,606.38
102.90	0.26	1.135	12,736.000	0.00	0.26	1,648.84
103.00	0.27	1.165	12,736.000	0.00	0.27	1,691.30
103.06	0.27	1.182	12,736.000	0.00	0.27	1,716.77
103.10	0.46	1.194	12,736.000	0.00	0.46	1,733.94
103.20	1.53	1.223	12,736.000	0.00	1.53	1,777.47
103.30	2.81	1.252	12,736.000	0.00	2.81	1,821.19
103.40	4.07	1.282	12,736.000	0.00	4.07	1,864.91
103.50	5.54	1.311	12,736.000	0.00	5.54	1,908.84
103.60	6.81	1.340	12,736.000	0.00	6.81	1,952.56
103.70	8.06	1.369	12,736.000	0.00	8.06	1,996.26
103.80	9.33	1.399	12,736.000	0.00	9.33	2,039.98
103.90	10.37	1.428	12,736.000	0.00	10.37	2,083.48
104.00	11.51	1.457	12,736.000	0.00	11.51	2,127.07
104.06	12.10	1.475	12,736.000	0.00	12.10	2,153.13

## Detention Vault

Subsection: Level Pool Pond Routing Summary

Return Event: 100 years

Label: 1 (IN)

Storm Event:

Scenario: EX10

---

### Infiltration

---

Infiltration Method (Computed)	No Infiltration
-----------------------------------	-----------------

---

### Initial Conditions

---

Elevation (Water Surface, Initial)	99.00 ft
Volume (Initial)	0.003 ac-ft
Flow (Initial Outlet)	0.08 ft <sup>3</sup> /s
Flow (Initial Infiltration)	0.00 ft <sup>3</sup> /s
Flow (Initial, Total)	0.08 ft <sup>3</sup> /s
Time Increment	1.000 min

---



---

### Inflow/Outflow Hydrograph Summary

---

Flow (Peak In)	31.00 ft <sup>3</sup> /s	Time to Peak (Flow, In)	248.000 min
Flow (Peak Outlet)	1.55 ft <sup>3</sup> /s	Time to Peak (Flow, Outlet)	308.000 min

---

Elevation (Water Surface, Peak)	103.20 ft
Volume (Peak)	1.224 ac-ft

---

### Mass Balance (ac-ft)

---

Volume (Initial)	0.003 ac-ft
Volume (Total Inflow)	1.430 ac-ft
Volume (Total Infiltration)	0.000 ac-ft
Volume (Total Outlet Outflow)	1.034 ac-ft
Volume (Retained)	0.399 ac-ft
Volume (Unrouted)	0.000 ac-ft
Error (Mass Balance)	0.0 %

---

## Detention Vault

Subsection: Pond Inflow Summary

Label: 1 (IN)

Scenario: EX10

Return Event: 100 years

Storm Event:

### Summary for Hydrograph Addition at '1'

Upstream Link	Upstream Node
<Catchment to Outflow Node>	CM-1

### Node Inflows

Inflow Type	Element	Volume (ac-ft)	Time to Peak (min)	Flow (Peak) (ft <sup>3</sup> /s)
Flow (From)	CM-1	1.430	248.000	31.00
Flow (In)	1	1.430	248.000	31.00

# Detention Vault

## Index

- 1
- 1 (Elevation-Area Volume Curve)...
- 1 (Elevation-Area Volume Curve, 100 years (EX10))...35
- 1 (Elevation-Volume-Flow Table (Pond))...
- 1 (Elevation-Volume-Flow Table (Pond), 100 years (EX10))...41, 42
- 1 (IN) (Level Pool Pond Routing Summary)...
- 1 (IN) (Level Pool Pond Routing Summary, 100 years (EX10))...43
- 1 (IN) (Pond Inflow Summary)...
- 1 (IN) (Pond Inflow Summary, 100 years (EX10))...44
- 1 (OUT) (Time vs. Elevation)...
- 1 (OUT) (Time vs. Elevation, 100 years (EX10))...5, 6, 7, 8, 9, 10, 11, 12, 13, 14, 15, 16, 17, 18, 19
- 1 (Time vs. Volume)...
- 1 (Time vs. Volume, 100 years (EX10))...20, 21, 22, 23, 24, 25, 26, 27, 28, 29, 30, 31, 32, 33, 34
- 1 (Volume Equations)...
- 1 (Volume Equations, 100 years (EX10))...36
- C
- CM-1 (Read Hydrograph)...
- CM-1 (Read Hydrograph, 100 years (EX10))...4
- M
- Master Network Summary...3
- O
- Outlet#1 (Outlet Input Data)...
- Outlet#1 (Outlet Input Data, 100 years (EX10))...37, 38, 39, 40
- U
- User Notifications...2

## **APPENDIX 6**

### **Drainage Exhibits**

INTERSTATE - 805 - M.S. 772

INTERSTATE 805

OTAY RIVER

88.8 (NGVD29)

SUM OF 3 SYSTEMS:  
TOTAL Q100 = 97.8 CFS  
TOTAL AREA = 38.5 AC

SYSTEM 100  
TOTAL Q100 = 51.1 CFS  
TOTAL AREA = 15.8 AC

SYSTEM 130  
TOTAL Q100 = 38.6 CFS  
TOTAL AREA = 18.9 AC

SYSTEM 160  
TOTAL Q100 = 8.9 CFS  
TOTAL AREA = 3.5 AC

MAP NO. 13724

PARCEL MAP NO. 1576

POR. OF N.E. OF THE S.E. 1/4 SEC. 24  
T. 18 S. R. 2 W. S.B.M.

DENNERY VILLAGES 2/3

DENNERY

PARCEL MAP NO. 17794

KAISER MEDICAL OFFICES

SUPPLEMENTAL TOPO FROM HUNSAKER  
DRAINAGE REPORT EXHIBIT (1997)

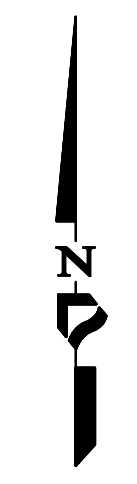

**LEGEND**

DRAINAGE SUBAREA	
HYDROLOGY NODE	
AREA FROM UPSTREAM TO DOWNSTREAM NODE	
DRAINAGE FLOWPATH	
FLOW DIRECTION	

**NOTE:**

- 1) TOPOGRAPHY IS BASED ON NGVD 29 TOPOGRAPHY.
- 2) A LETTER OF MAP AMENDMENT (LOMA) (CASE REFERENCE #20-09-1145A) WAS PERFORMED AND CERTIFIED THAT THE EXISTING PROPERTY ELEVATIONS WITHIN THE NAKANO PROJECT ARE ABOVE THE ZONE A SPECIAL FLOOD HAZARD AREA BASE FLOOD ELEVATIONS FOR THE OTAY RIVER. THE ENTIRE PROPERTY WAS REMOVED FROM THE 100-YEAR FLOODPLAIN LIMITS.

SCALE: 1"=60'  
JOB #: 4409.02  
CREATED: 12/26/19

PREPARED BY:  
  
**PROJECT DESIGN CONSULTANTS**  
Planning | Landscape Architecture | Environmental | Engineering | Survey  
701 B Street, Suite 800 San Diego, CA 92101  
619.235.6471 Tel 619.234.0349 Fax

**CITY OF SAN DIEGO**  
**NAKANO**  
**DRAINAGE MAP**  
**EXISTING CONDITIONS**  
**EXHIBIT A**



OTAY RIVER

INTERSTATE 805

DENNERLY VILLAGES 2/3

LOT 1

DENNERLY

SYSTEM 1100 (INCLUDING SYS 1000)  
TOTAL Q100(UNDETAINED) = 42.8 CFS  
TOTAL Q100(DETAINED) = 14.2 CFS  
TOTAL AREA = 16.3 AC

SYSTEM 1200  
TOTAL Q100 = 51.9 CFS  
TOTAL AREA = 16.3 AC

SYSTEM 1300  
TOTAL Q100 = 6.5 CFS  
TOTAL AREA = 2.7 AC

SYSTEM 1600  
TOTAL Q100 = 7.7 CFS  
TOTAL AREA = 3.3 AC

LIMITS OF FEMA 100-YEAR FLOODWAY  
PER FIRM 06073C2158C

LIMITS OF FEMA 100-YEAR FLOODPLAIN  
PER FIRM 06073C2158C

88.8 (NGVD29)

DAVIS PARCEL MAP NO. 624-074-01  
P.R. NO. 2000-0632  
DATED 5/10/2002

OFFSITE BYPASS

PROPERTY BOUNDARY

OFFSITE BYPASS

SUPPLEMENTAL TOPO FROM  
HUNSAKER DRAINAGE  
REPORT EXHIBIT (1997)

KAISER MEDICAL OFFICES

Hunsaker 37  
Q50 = 22.2 cfs  
A = 5.5 ac

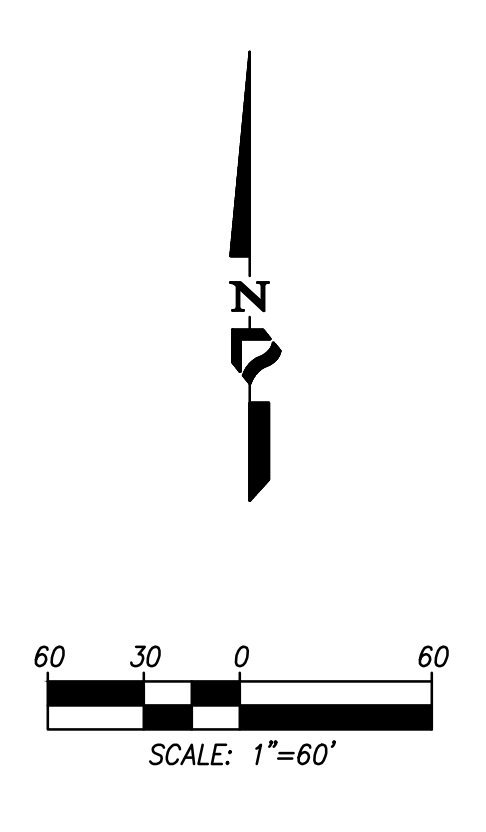

**LEGEND**

DRAINAGE MANAGEMENT AREA	
HYDROLOGY NODE	
AREA FROM UPSTREAM TO DOWNSTREAM NODE	
DRAINAGE FLOWPATH	

**NOTE:**

- 1) TOPOGRAPHY IS BASED ON NGVD 29 TOPOGRAPHY.
- 2) A LETTER OF MAP AMENDMENT (LOMA) (CASE REFERENCE #20-09-1145A) WAS PERFORMED AND CERTIFIED THAT THE EXISTING PROPERTY ELEVATIONS WITHIN THE NAKANO PROJECT ARE ABOVE THE ZONE A SPECIAL FLOOD HAZARD AREA BASE FLOOD ELEVATIONS FOR THE OTAY RIVER. THE ENTIRE PROPERTY WAS REMOVED FROM THE 100-YEAR FLOODPLAIN LIMITS.

SCALE: 1"=60"	PREPARED BY:
JOB #: 4409.02	
CREATED: 3/11/20	<b>PROJECT DESIGN CONSULTANTS</b> Planning   Landscape Architecture   Environmental   Engineering   Survey 701 B Street, Suite 800 San Diego, CA 92101 619.235.6711 Tel 619.234.0349 Fax

<b>CITY OF CHULA VISTA</b>
<b>NAKANO</b>
<b>DRAINAGE MAP</b>
<b>PROPOSED CONDITIONS</b>
<b>EXHIBIT B</b>



## **APPENDIX 7**

### **FEMA Approval Letter for LOMA**



# Federal Emergency Management Agency

Washington, D.C. 20472

## LETTER OF MAP AMENDMENT DETERMINATION DOCUMENT (REMOVAL)

COMMUNITY AND MAP PANEL INFORMATION		LEGAL PROPERTY DESCRIPTION
COMMUNITY	CITY OF CHULA VISTA, SAN DIEGO COUNTY, CALIFORNIA	A portion of Section 24, Township 18 South, Range 2 West, San Bernardino Meridian, as described in the Grant Deed recorded as Document No. 2004-0777337, Pages 13994 and 13995, in the Office of the County Recorder, San Diego County, California (APN: 624-071-02)
	COMMUNITY NO.: 065021	
AFFECTED MAP PANEL	NUMBER: 06073C2158G DATE: 5/16/2012	
FLOODING SOURCE: OTAY RIVER		APPROXIMATE LATITUDE & LONGITUDE OF PROPERTY: 32.588896, -117.033960 SOURCE OF LAT & LONG: LOMA LOGIC DATUM: NAD 83

### DETERMINATION

LOT	BLOCK/ SECTION	SUBDIVISION	STREET	OUTCOME WHAT IS REMOVED FROM THE SFHA	FLOOD ZONE	1% ANNUAL CHANCE FLOOD ELEVATION (NAVD 88)	LOWEST ADJACENT GRADE ELEVATION (NAVD 88)	LOWEST LOT ELEVATION (NAVD 88)
--	--	--	--	Property	X (shaded)	--	--	97.9 feet

**Special Flood Hazard Area (SFHA)** - The SFHA is an area that would be inundated by the flood having a 1-percent chance of being equaled or exceeded in any given year (base flood).

**ADDITIONAL CONSIDERATIONS** (Please refer to the appropriate section on Attachment 1 for the additional considerations listed below.)

STATE LOCAL CONSIDERATIONS

This document provides the Federal Emergency Management Agency's determination regarding a request for a Letter of Map Amendment for the property described above. Using the information submitted and the effective National Flood Insurance Program (NFIP) map, we have determined that the property(ies) is/are not located in the SFHA, an area inundated by the flood having a 1-percent chance of being equaled or exceeded in any given year (base flood). This document amends the effective NFIP map to remove the subject property from the SFHA located on the effective NFIP map; therefore, the Federal mandatory flood insurance requirement does not apply. However, the lender has the option to continue the flood insurance requirement to protect its financial risk on the loan. A Preferred Risk Policy (PRP) is available for buildings located outside the SFHA. Information about the PRP and how one can apply is enclosed.

This determination is based on the flood data presently available. The enclosed documents provide additional information regarding this determination. If you have any questions about this document, please contact the FEMA Map Information eXchange (FMIX) toll free at (877) 336-2627 (877-FEMA MAP) or by letter addressed to the Federal Emergency Management Agency, Engineering Library, 3601 Eisenhower Ave Ste 500, Alexandria, VA 22304-6426.

Luis V. Rodriguez, P.E., Director  
Engineering and Modeling Division  
Federal Insurance and Mitigation Administration



# Federal Emergency Management Agency

Washington, D.C. 20472

## LETTER OF MAP AMENDMENT DETERMINATION DOCUMENT (REMOVAL)

ATTACHMENT 1 (ADDITIONAL CONSIDERATIONS)

### STATE AND LOCAL CONSIDERATIONS (This Additional Consideration applies to all properties in the LOMA DETERMINATION DOCUMENT (REMOVAL))

Please note that this document does not override or supersede any State or local procedural or substantive provisions which may apply to floodplain management requirements associated with amendments to State or local floodplain zoning ordinances, maps, or State or local procedures adopted under the National Flood Insurance Program.

This attachment provides additional information regarding this request. If you have any questions about this attachment, please contact the FEMA Map Information eXchange (FMIX) toll free at (877) 336-2627 (877-FEMA MAP) or by letter addressed to the Federal Emergency Management Agency, Engineering Library, 3601 Eisenhower Ave Ste 500, Alexandria, VA 22304-6426.

A handwritten signature in black ink, appearing to read "Luis V. Rodriguez".

Luis V. Rodriguez, P.E., Director  
Engineering and Modeling Division  
Federal Insurance and Mitigation Administration



# Federal Emergency Management Agency

Washington, D.C. 20472

**May 22, 2020**

MS. CHELISA PACK  
PROJECT DESIGN CONSULTANTS  
701 B STREET  
SUITE 800  
SAN DIEGO, CA 92101

**CASE NO.: 20-09-1145A**  
COMMUNITY: CITY OF CHULA VISTA, SAN DIEGO  
COUNTY, CALIFORNIA  
COMMUNITY NO.: 065021

DEAR MS. PACK:

This is in reference to a request that the Federal Emergency Management Agency (FEMA) determine if the property described in the enclosed document is located within an identified Special Flood Hazard Area, the area that would be inundated by the flood having a 1-percent chance of being equaled or exceeded in any given year (base flood), on the effective National Flood Insurance Program (NFIP) map. Using the information submitted and the effective NFIP map, our determination is shown on the attached Letter of Map Amendment (LOMA) Determination Document. This determination document provides additional information regarding the effective NFIP map, the legal description of the property and our determination.

Additional documents are enclosed which provide information regarding the subject property and LOMAs. Please see the List of Enclosures below to determine which documents are enclosed. Other attachments specific to this request may be included as referenced in the Determination/Comment document. If you have any questions about this letter or any of the enclosures, please contact the FEMA Map Information eXchange (FMIX) toll free at (877) 336-2627 (877-FEMA MAP) or by letter addressed to the Federal Emergency Management Agency, Engineering Library, 3601 Eisenhower Ave Ste 500, Alexandria, VA 22304-6426.

Sincerely,

Luis V. Rodriguez, P.E., Director  
Engineering and Modeling Division  
Federal Insurance and Mitigation Administration

**LIST OF ENCLOSURES:**

LOMA DETERMINATION DOCUMENT (REMOVAL)

cc: State/Commonwealth NFIP Coordinator  
Community Map Repository  
Region



# Federal Emergency Management Agency

Washington, D.C. 20472

## **ADDITIONAL INFORMATION REGARDING LETTERS OF MAP AMENDMENT**

When making determinations on requests for Letters of Map Amendment (LOMAs), the Department of Homeland Security's Federal Emergency Management Agency (FEMA) bases its determination on the flood hazard information available at the time of the determination. Requesters should be aware that flood conditions may change or new information may be generated that would supersede FEMA's determination. In such cases, the community will be informed by letter.

Requesters also should be aware that removal of a property (parcel of land or structure) from the Special Flood Hazard Area (SFHA) means FEMA has determined the property is not subject to inundation by the flood having a 1-percent chance of being equaled or exceeded in any given year (base flood). This does not mean the property is not subject to other flood hazards. The property could be inundated by a flood with a magnitude greater than the base flood or by localized flooding not shown on the effective National Flood Insurance Program (NFIP) map.

The effect of a LOMA is it removes the Federal requirement for the lender to require flood insurance coverage for the property described. The LOMA *is not* a waiver of the condition that the property owner maintain flood insurance coverage for the property. *Only* the lender can waive the flood insurance purchase requirement because the lender imposed the requirement. *The property owner must request and receive a written waiver from the lender before canceling the policy.* The lender may determine, on its own as a business decision, that it wishes to continue the flood insurance requirement to protect its financial risk on the loan.

The LOMA provides FEMA's comment on the mandatory flood insurance requirements of the NFIP as they apply to a particular property. A LOMA is not a building permit, nor should it be construed as such. Any development, new construction, or substantial improvement of a property impacted by a LOMA must comply with all applicable State and local criteria and other Federal criteria.

If a lender releases a property owner from the flood insurance requirement, and the property owner decides to cancel the policy and seek a refund, the NFIP will refund the premium paid for the current policy year, provided that no claim is pending or has been paid on the policy during the current policy year. The property owner must provide a written waiver of the insurance requirement from the lender to the property insurance agent or company servicing his or her policy. The agent or company will then process the refund request.

Even though structures are not located in an SFHA, as mentioned above, they could be flooded by a flooding event with a greater magnitude than the base flood. In fact, more than 25 percent of all claims paid by the NFIP are for policies for structures located outside the SFHA in Zones B, C, X (shaded), or X (unshaded). More than one-fourth of all policies purchased under the NFIP protect structures located in these zones. The risk to structures located outside SFHAs is just not as great as the risk to structures located in SFHAs. Finally, approximately 90 percent of all federally declared disasters are caused by flooding, and homeowners insurance does not provide financial protection from this flooding. Therefore, FEMA encourages the widest possible coverage under the NFIP.

The NFIP offers two types of flood insurance policies to property owners: the low-cost Preferred Risk Policy (PRP) and the Standard Flood Insurance Policy (SFIP). The PRP is available for 1- to 4-family residential structures located outside the SFHA with little or no loss history. The PRP is available for townhouse/rowhouse-type structures, but is not available for other types of condominium units. The SFIP is available for all other structures. Additional information on the PRP and how a property owner can qualify for this type of policy may be obtained by calling the Flood Insurance Information Hotline, toll free, at 1-800-427-4661. Before making a final decision about flood insurance coverage, FEMA strongly encourages property owners to discuss their individual flood risk situations and insurance needs with an insurance agent or company.

FEMA has established "Grandfather" rules to benefit flood insurance policyholders who have maintained continuous coverage. Property owners may wish to note also that, if they live outside but on the fringe of the SFHA shown on an effective NFIP map and the map is revised to expand the SFHA to include their structure(s), their flood insurance policy rates will not increase as long as the coverage for the affected structure(s) has been continuous. Property owners would continue to receive the lower insurance policy rates.

LOMAs are based on minimum criteria established by the NFIP. State, county, and community officials, based on knowledge of local conditions and in the interest of safety, may set higher standards for construction in the SFHA. If a State, county, or community has adopted more restrictive and comprehensive floodplain management criteria, these criteria take precedence over the minimum Federal criteria.

In accordance with regulations adopted by the community when it made application to join the NFIP, letters issued to amend an NFIP map must be attached to the community's official record copy of the map. That map is available for public inspection at the community's official map repository. Therefore, FEMA sends copies of all such letters to the affected community's official map repository.

When a restudy is undertaken, or when a sufficient number of revisions or amendments occur on particular map panels, FEMA initiates the printing and distribution process for the affected panels. FEMA notifies community officials in writing when affected map panels are being physically revised and distributed. In such cases, FEMA attempts to reflect the results of the LOMA on the new map panel. If the results of particular LOMAs cannot be reflected on the new map panel because of scale limitations, FEMA notifies the community in writing and revalidates the LOMAs in that letter. LOMAs revalidated in this way usually will become effective 1 day after the effective date of the revised map.

**Nakano**  
**LETTER OF MAP AMENDMENT**  
**(LOMA)**

FEMA, City of Chula Vista  
**May 18, 2020**

**FIRM # 06073C2158G**

Prepared For:

**Pardee Homes**  
13400 Sabre Springs Parkway, Suite 200  
San Diego, California 92128

Prepared By:



**PROJECT DESIGN CONSULTANTS**

Planning | Landscape Architecture | Environmental | Engineering | Survey

701 B Street, Suite 800  
San Diego, CA 92101  
619.235.6471 Tel  
619.234.0349 Fax

PDC Job No. 4409.02



Prepared by: J. Novoa, P.E.

*Under the supervision of:*

Chelisa Pack, PE RCE 71026  
Registration Expires 06/30/21

# TABLE OF CONTENTS

1.	INTRODUCTION .....	1
2.	SUMMARY OF METHODOLOGY .....	1
2.1	Existing Condition of the Property .....	1
2.2	Floodplain Base Flood Elevation Comparison .....	2
3.	CONCLUSIONS.....	2

## APPENDICES

1	FEMA Forms, Package MT-1
2	Exhibits



## **1. INTRODUCTION**

This Letter of Map Amendment (LOMA) has been prepared in order to certify that the existing property within the Nakano project in the City of Chula Vista, California is above the flood elevations as indicated on the NFIP map.

The purpose of the application is to demonstrate that the existing elevations of the Nakano property are above the flood elevations indicated by Zone AE as shown in the FIRM Panel No. 06073C2158G, effective date May 16, 2012. The Zone AE floodplain extends along the north portion of the site with water surface elevations ranging from 83.8 to 92.7 ft. MSL (NGVD 29). Note that there a 2.17 conversion from NAVD88 to NGVD29 datum. The elevations listed on the exhibit show elevations per the NGVD29 datum.

## **2. SUMMARY OF METHODOLOGY**

The following summarizes how the base flood elevations were determined in order to ensure the existing elevations are above the base flood and enable their removal from the special flood hazard area mapping.

### **2.1 Existing Condition of the Property**

The Nakano site consists of approximately 23.8 acres of existing hillside and grass land use located within the Otay Mesa neighborhood of the City of Chula Vista. The site is bounded by Kaiser Permanente medical offices to the South, Interstate 805 to the West, an existing residential site to the east and Otay River to the North. Existing condition onsite includes grassland, hillside, utilities facilities, and a small dirt paths traversing the property.

Per the FIRM panel, in the existing condition, the floodplain encroaches into the site along the northern extents of the project boundary. Along the northern portion of the property the site is affected by Zone AE. Refer to Exhibit A-1 for the existing floodplain exhibit depicting the relationship of the floodplain to the property.

## **2.2 Floodplain Base Flood Elevation Comparison**

The base flood elevations (BFE) were taken from the FEMA FIRM Panel No. 06073C2158G, effective date May 16, 2012. The Zone AE floodplain extends along the north portion of the site with water surface elevations ranging from 83.8 to 92.7 ft. MSL (NGVD 29). The lowest point on the site along the northern property line is 95.7, three feet above the highest floodplain elevation at the northwest corner of the site of 92.7. This comparison of the worst case scenario of the lowest elevation on the existing property is still three feet higher than the highest floodway elevation at any point on site indicates that the entire site can be removed from the special flood hazard area mapping.

## **3. CONCLUSIONS**

The existing property elevations indicate that the entire site is higher than the determined Zone AE special flood hazard area base flood elevations for the Otay River. Therefore, this report supports a recommendation that the entire property identified be removed from the 100-year floodplain limits.

**APPENDIX 1**  
**FEMA Forms, Package MT-1**

**MT-1 Form 1**  
**Property Information**

**PAPERWORK BURDEN DISCLOSURE NOTICE**

Public reporting burden for this data collection is estimated to average 1.63 hours per response. The burden estimate includes the time for reviewing instructions, searching existing data sources, gathering and maintaining the needed data, and completing and submitting the form. This collection is required to obtain or retain benefits. You are not required to respond to this collection of information unless a valid OMB control number is displayed on this form. Send comments regarding the accuracy of the burden estimate and any suggestions for reducing this burden to: Information Collections Management, Department of Homeland Security, Federal Emergency Management Agency, 1800 South Bell Street, Arlington, VA 20598-3005, Paperwork Reduction Project (1660-0015). **NOTE: Do not send your completed form to this address.**

This form may be completed by the property owner, property owner's agent, licensed land surveyor, or registered professional engineer to support a request for a Letter of Map Amendment (LOMA), Conditional Letter of Map Amendment (CLOMA), Letter of Map Revision Based on Fill (LOMR-F), or Conditional Letter of Map Revision Based on Fill (CLOMR-F) for existing or proposed, single or multiple lots/structures. In order to process your request, all information on this form must be completed *in its entirety*, unless stated as optional. **Incomplete submissions will result in processing delays.** Please check the item below that describes your request:

<input type="checkbox"/> LOMA	A letter from DHS-FEMA stating that an existing structure or parcel of land that has not been elevated by fill (natural grade) would not be inundated by the base flood.
<input type="checkbox"/> CLOMA	A letter from DHS-FEMA stating that a proposed structure that is not to be elevated by fill (natural grade) would not be inundated by the base flood if built as proposed.
<input type="checkbox"/> LOMR-F	A letter from DHS-FEMA stating that an <b>existing</b> structure or parcel of land that has been <b>elevated by fill</b> would not be inundated by the base flood.
<input type="checkbox"/> CLOMR-F	A letter from DHS-FEMA stating that a parcel of land or <b>proposed</b> structure that will be <b>elevated by fill</b> would not be inundated by the base flood if fill is placed on the parcel as proposed or the structure is built as proposed.

**Fill** is defined as material from any source (including the subject property) placed that raises the ground to or above the Base Flood Elevation (BFE). The common construction practice of removing unsuitable existing material (topsoil) and backfilling with select structural material is not considered the placement of fill if the practice does not alter the existing (natural grade) elevation, which is at or above the BFE. **Fill that is placed before the date of the first National Flood Insurance Program (NFIP) map showing the area in a Special Flood Hazard Area (SFHA) is considered natural grade.**

Has fill been placed on your property to raise ground that was previously below the BFE?  Yes  No      If yes, when was fill placed? \_\_\_\_\_ / \_\_\_\_\_ month/year

Will fill be placed on your property to raise ground that is below the BFE?  Yes\*  No      If yes, when will fill be placed? \_\_\_\_\_ / \_\_\_\_\_ month/year

\* If yes, Endangered Species Act (ESA) compliance must be documented to FEMA prior to issuance of the CLOMR-F determination (please refer page 4 to the MT-1 instructions).

- Street Address of the Property (if request is for multiple structures or units, please attach additional sheet referencing each address and enter street names below):
- Legal description of Property (Lot, Block, Subdivision or abbreviated description from the Deed):
- Are you requesting that a flood zone determination be completed for (check one):
  - Structures on the property? What are the dates of construction? \_\_\_\_\_ (MM/YYYY)
  - A portion of land within the bounds of the property? (A certified metes and bounds description and map of the area to be removed, certified by a licensed land surveyor or registered professional engineer, are **required**. For the preferred format of metes and bounds descriptions, please refer to the MT-1 Form 1 Instructions.)
  - The entire legally recorded property?
- Is this request for a (check one):
  - Single structure
  - Single lot
  - Multiple structures (How many structures are involved in your request? List the number: \_\_\_\_\_)
  - Multiple lots (How many lots are involved in your request? List the number: \_\_\_\_\_)

In addition to this form (MT-1 Form 1), please complete the checklist below. ALL requests must include one copy of the following:

- Copy of the effective FIRM panel on which the structure and/or property location has been accurately plotted (property inadvertently located in the NFIP regulatory floodway will require Section B of MT-1 Form 3)
- Copy of the Subdivision Plat Map for the property (with recordation data and stamp of the Recorder's Office)  
OR
- Copy of the Property Deed (with recordation data and stamp of the Recorder's Office), accompanied by a tax assessor's map or other certified map showing the surveyed location of the property relative to local streets and watercourses. The map should include at least one street intersection that is shown on the FIRM panel.
- Form 2 – Elevation Form. If the request is to remove the structure, and an Elevation Certificate has already been completed for this property, it may be submitted in lieu of Form 2. If the request is to remove the entire legally recorded property, or a portion thereof, the lowest lot elevation must be provided on Form 2.
- Please include a map scale and North arrow on all maps submitted.

For LOMR-Fs and CLOMR-Fs, the following must be submitted in addition to the items listed above:

- Form 3 – Community Acknowledgment Form

For CLOMR-Fs, the following must be submitted in addition to the items listed above:

- Documented ESA compliance, which may include a copy of an Incidental Take Permit, an Incidental Take Statement, a "not likely to adversely affect" determination from the National Marine Fisheries Service (NMFS) or the U.S. Fish and Wildlife Service (USFWS), or an official letter from NMFS or USFWS concurring that the project has "No Effect" on proposed or listed species or designated critical habitat. Please refer to the MT-1 instructions for additional information.

Please do *not* submit original documents. Please retain a copy of all submitted documents for your records.

DHS-FEMA encourages the submission of all required data in a digital format (e.g. scanned documents and images on Compact Disc [CD]). Digital submissions help to further DHS-FEMA's Digital Vision and also may facilitate the processing of your request.

Incomplete submissions will result in processing delays. For additional information regarding this form, including where to obtain the supporting documents listed above, please refer to the MT-1 Form Instructions located at [http://www.fema.gov/plan/prevent/fhm/dl\\_mt-1.shtm](http://www.fema.gov/plan/prevent/fhm/dl_mt-1.shtm).

**Processing Fee** (see instructions for appropriate mailing address; or visit [http://www.fema.gov/fhm/frm\\_fees.shtm](http://www.fema.gov/fhm/frm_fees.shtm) for the most current fee schedule)

Revised fee schedules are published periodically, but no more than once annually, as noted in the **Federal Register**. Please note: single/multiple lot(s)/structure(s) LOMAs are fee exempt. The current review and processing fees are listed below:

Check the fee that applies to your request:

- \$325 (single lot/structure LOMR-F following a CLOMR-F)
- \$425 (single lot/structure LOMR-F)
- \$500 (single lot/structure CLOMA or CLOMR-F)
- \$700 (multiple lot/structure LOMR-F following a CLOMR-F, or multiple lot/structure CLOMA)
- \$800 (multiple lot/structure LOMR-F or CLOMR-F)

Please submit the Payment Information Form for remittance of applicable fees. Please make your check or money order payable to:  
**National Flood Insurance Program.**

All documents submitted in support of this request are correct to the best of my knowledge. I understand that any false statement may be punishable by fine or imprisonment under Title 18 of the United States Code, Section 1001.

Applicant's Name (required): Chelisa Pack

Company (if applicable): Project Design Consultants

Mailing Address (required):

701 B St., Suite 800, San Diego, CA 92101

Daytime Telephone No. (required): (619) 235-6471

E-Mail Address (optional):  By checking here you may receive correspondence electronically at the email address provided):

Fax No. (optional): (619) 234-0349

chelisap@projectdesign.com

Date (required)

4/7/2020



Signature of Applicant (required)

## LEGAL DESCRIPTION

### PARCEL 1:

THAT PORTION OF THE NORTHEAST QUARTER OF THE SOUTHWEST QUARTER OF SECTION 24, TOWNSHIP 18 SOUTH, RANGE 2 WEST, SAN BERNARDINO MERIDIAN IN THE CITY OF CHULA VISTA, COUNTY OF SAN DIEGO, STATE OF CALIFORNIA, ACCORDING TO THE OFFICIAL PLAT THEREOF DESCRIBED AS FOLLOWS:

BEGINNING AT THE SOUTHEAST CORNER OF SAID NORTHEAST QUARTER OF THE SOUTHEAST QUARTER; THENCE ALONG THE SOUTH LINE THEREOF SOUTH 89°42'04" WEST, 1069.30 FEET TO THE EASTERLY LINE OF FREEWAY DESCRIBED IN FINAL ORDER OF CONDEMNATION RECORDED JULY 22, 1968 AS FILE NO. 123499 OFFICAL RECORDS; THENCE ALONG SAID EASTERLY LINE NORTH 3°47'10" EAST, 918.10 FEET; THENCE NORTH 80°52'26" EAST, 1030.62 FEET TO THE EAST LINE OF SAID SECTION: THENCE ALONG SAID EAST LINE SOUTH 0°28'33" WEST, 1074.02 FEET TO THE POINT OF BEGINNING.

### PARCEL 2:

AN EASEMENT FOR ROAD AND WATER PIPELINE PURPOSES 15 FEET WIDE ALONG THE EXSTING TRAVELED ROAD ACROSS THE SOUTHEAST QUARTER OF THE NORTHEAST QUARTER AND THAT PORTION OF THE NORTHEAST QUARTER OF THE SOUTHEAST QUARTER OF SAID SECTION LYING NORTHERLY OF THE NORTHERLY LINE OF PARCEL 1 ABOVE.

EXCEPTING THAT PORTION LYING WITHIN SAID FREEWAY AND OTAY VALLEY ROAD.

## **Annotated FIRM Panel**



**NOTES TO USERS**

This map is for use in administering the National Flood Insurance Program. It does not necessarily identify all areas subject to flooding, particularly from local drainage sources of small size. The community map repository should be consulted for possible updated or additional flood hazard information.

To obtain more detailed information in areas where **Base Flood Elevations (BFEs)** and/or **Floodway Data** have been determined, users are encouraged to consult the Flood Profiles and Floodway Data and/or Summary of Stillwater Elevations tables contained within the Flood Insurance Study (FIS) report that accompanies this FIRM. Users should be aware that BFEs shown on the FIRM represent rounded whole-foot elevations. These BFEs are intended for flood insurance rating purposes only and should not be used as the sole source of flood elevation information. Accordingly, flood elevation data presented in the FIS report should be utilized in conjunction with the FIRM for purposes of construction and/or floodplain management.

**Coastal Base Flood Elevations (CBEs)** shown on this map apply only to landward of 0.0' North American Vertical Datum of 1988 (NAVD 88). Users of this FIRM should be aware that coastal flood elevations are also provided in the Summary of Stillwater Elevations table in the Flood Insurance Study report for this jurisdiction. Elevations shown in the Summary of Stillwater Elevations table should be used for construction and/or floodplain management purposes when they are higher than the elevations shown on this FIRM.

Boundaries of the floodways were computed at cross sections and interpolated between cross sections. The floodways were based on hydraulic considerations with regard to requirements of the National Flood Insurance Program. Floodway widths and other pertinent floodway data are provided in the Flood Insurance Study report for this jurisdiction.

Certain areas not in Special Flood Hazard Areas may be protected by **flood control structures**. Refer to Section 2.4 "Flood Protection Measures" of the Flood Insurance Study report for information on flood control structures for this jurisdiction.

The projection used in the preparation of this map was Universal Transverse Mercator (UTM) Zone 11. The horizontal datum was NAD83, GRS1980 spheroid. Differences in datum, spheroid, projection or UTM zones used in the production of FIRMs for adjacent jurisdictions may result in slight positional differences in map features across jurisdiction boundaries. These differences do not affect the accuracy of this FIRM.

Flood elevations on this map are referenced to the North American Vertical Datum of 1988. These flood elevations must be compared to structure and ground elevations referenced to the same vertical datum. For information regarding conversion between the National Geodetic Vertical Datum of 1929 and the North American Vertical Datum of 1988, visit the National Geodetic Survey website at <http://www.ngs.noaa.gov> or contact the National Geodetic Survey at the following address:

NGS Information Services  
NCA, NING512  
National Geodetic Survey  
SSMC-3, #9202  
1315 East-West Highway  
Silver Spring, Maryland 20910-3282  
(301) 713-3242

To obtain current elevation, description, and/or location information for **bench marks** shown on this map, please contact the Information Services Branch of the National Geodetic Survey at (301) 713-3242 or visit its website at <http://www.ngs.noaa.gov/>.

**Base map** information shown on this FIRM was provided in digital format by the USDA National Agriculture Imagery Program (NAIP). This information was photogrammetrically compiled at a scale of 1:24,000 from aerial photography dated 2009.

This map reflects more detailed and up-to-date stream channel configurations and floodways than those shown on the previous FIRM for this jurisdiction. The floodplains and floodways that were transferred from the previous FIRM may have been adjusted to conform to these new stream channel configurations. As a result, the Flood Profiles and Floodway Data tables in the Flood Insurance Study report (which contains authoritative hydraulic data) may reflect stream channel distances that differ from what is shown on this map.

**Corporate limits** shown on this map are based on the best data available at the time of publication. Because changes due to annexations or de-annexations may have occurred after this map was published, map users should contact appropriate community officials to verify current corporate limit locations.

Please refer to the separately printed **Map Index** for an overview map of the county showing the layout of map panels, community map repository addresses, and a Listing of Communities table containing National Flood Insurance Program dates for each community as well as a listing of the panels on which each community is located.

Contact the **FEMA Map Service Center** at 1-877-FEMA-MAP (1-877-336-2627) for information on available products associated with this FIRM. Available products may include previously issued Letters of Map Change, a Flood Insurance Study report, and/or digital versions of this map. The FEMA Map Service Center may also be reached by fax at 1-800-356-9620 and its website at <http://msc.fema.gov/>.

If you have questions about this map or questions concerning the National Flood Insurance Program in general, please call 1-877-FEMA-MAP (1-877-336-2627) or visit the FEMA website at <http://www.fema.gov/business/nfip/>.

The "profile base lines" depicted on this map represent the hydraulic modeling baselines that match the flood profiles in the FIS report. As a result of improved topographic data, the "profile base line", in some cases, may deviate significantly from the channel centerline or appear outside the SFHA.

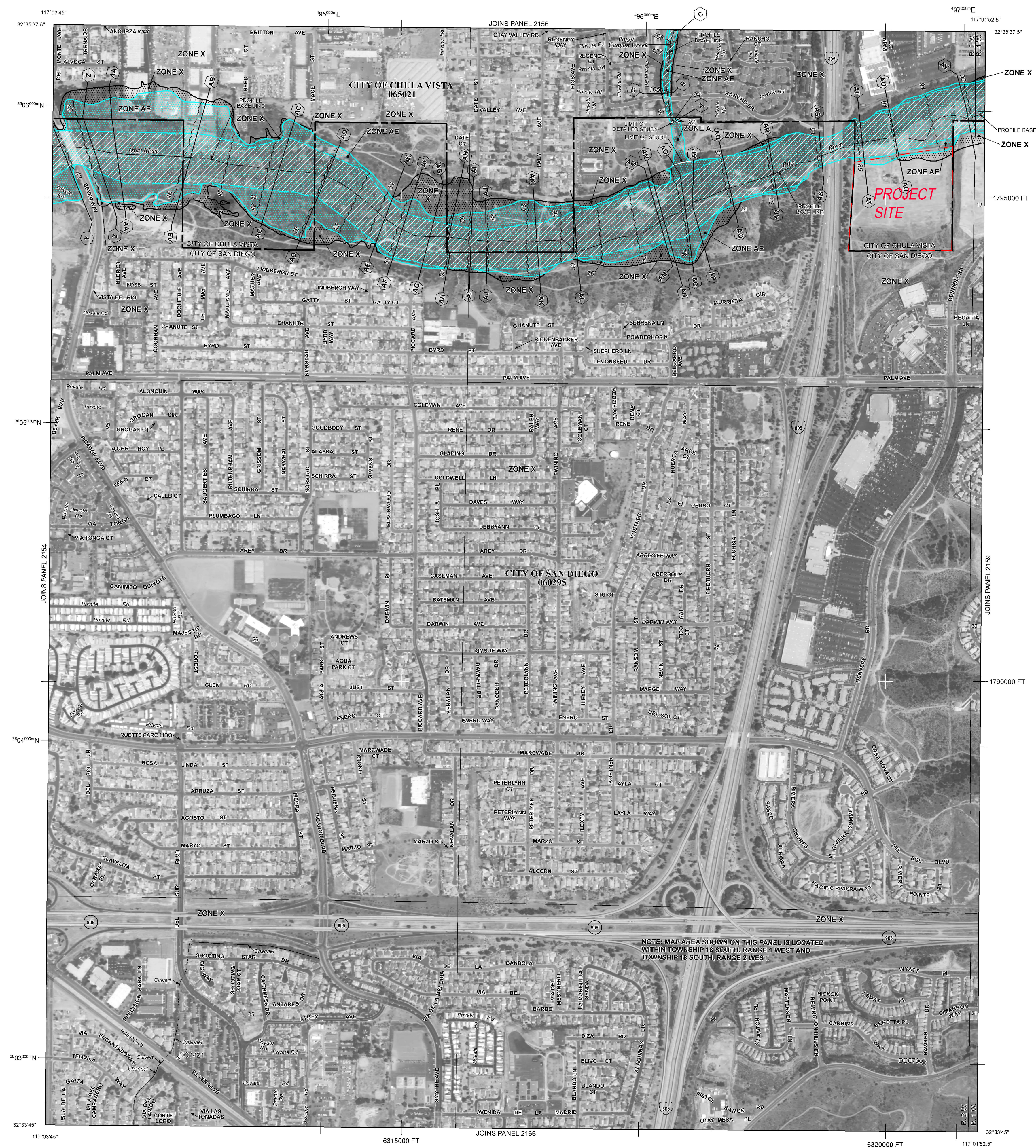

**LEGEND**

**SPECIAL FLOOD HAZARD AREAS SUBJECT TO INUNDATION BY THE 1% ANNUAL CHANCE FLOOD**

The 1% annual chance flood (100-year flood), also known as the base flood, is the flood that has a 1% chance of being equaled or exceeded in any given year. The Special Flood Hazard Area is the area subject to flooding by the 1% annual chance flood. Areas of Special Flood Hazard include Zones A, AE, AH, AO, AR, A99, V, and VE. The Base Flood Elevation is the water-surface elevation of the 1% annual chance flood.

- ZONE A** No Base Flood Elevations determined.
- ZONE AE** Base Flood Elevations determined.
- ZONE AH** Flood depths of 1 to 3 feet (usually areas of ponding); Base Flood Elevations determined.
- ZONE AO** Flood depths of 1 to 3 feet (usually shelf flow on sloping terrain); average depths determined. For areas of alluvial fan flooding, velocities also determined.
- ZONE AR** Special Flood Hazard Area formerly protected from the 1% annual chance flood by a flood control system that was subsequently destroyed. Zone AR indicates that the former flood control system is being restored to provide protection from the 1% annual chance or greater flood.
- ZONE A99** Areas to be protected from 1% annual chance flood event by a Federal flood protection system under construction; no Base Flood Elevations determined.
- ZONE V** Coastal flood zone with velocity hazard (wave action); no Base Flood Elevations determined.
- ZONE VE** Coastal flood zone with velocity hazard (wave action); Base Flood Elevations determined.

**FLOODWAY AREAS IN ZONE AE**

The floodway is the channel of a stream plus any adjacent floodplain areas that must be kept free of encroachment so that the 1% annual chance flood can be carried without substantial increases in flood heights.

**OTHER FLOOD AREAS**

- ZONE X** Areas of 0.2% annual chance flood; areas of 1% annual chance flood with average depths of less than 1 foot or with drainage areas less than 1 square mile; and areas protected by levees from 1% annual chance flood.

**OTHER AREAS**

- ZONE D** Areas determined to be outside the 0.2% annual chance floodplain.
- ZONE F** Areas in which flood hazards are undetermined, but possible.

**COASTAL BARRIER RESOURCES SYSTEM (CBRS) AREAS**

**OTHERWISE PROTECTED AREAS (OPAs)**

CBRS areas and OPAs are normally located within or adjacent to Special Flood Hazard Areas.

- 1% annual chance floodplain boundary
- 0.2% annual chance floodplain boundary
- Floodway boundary
- Floodway boundary
- Zone D boundary
- Zone F boundary
- CBRS and OPA boundary
- Boundary dividing Special Flood Hazard Area Zones and boundary dividing Special Flood Hazard Areas of different Base Flood Elevations, flood depths, or flood velocities
- Base Flood Elevation line and value; elevation in feet\*
- Base Flood Elevation value where uniform within zone; elevation in feet\*

\* Referenced to the North American Vertical Datum of 1988

- A—A Cross section line
- ②—② Transect line

Geographic coordinates referenced to the North American Datum of 1983 (NAD 83), Western Hemisphere

47°50'00"E  
1000-meter Universal Transverse Mercator grid ticks, zone 11  
5000-foot grid values: California State Plane coordinate system, Zone VI (FIPS ZONE = 405), Lambert projection  
Bench mark (see explanation in Notes to Users section of this FIRM panel)

- M1.5 River Mile

**MAP REPOSITORIES**

Refer to Map Repositories list on Map Index.

**EFFECTIVE DATE OF COUNTYWIDE FLOOD INSURANCE RATE MAP**  
June 19, 1997

**EFFECTIVE DATE(S) OF REVISION(S) TO THIS PANEL**  
May 16, 2012 – to update corporate limits, to add roads and road names, to incorporate previously issued Letters of Map Revision, and to update map elevations to North American Vertical Datum of 1988.

For community map revision history prior to countywide mapping, refer to the Community Map History table located in the Flood Insurance Study report for this jurisdiction.

To determine if flood insurance is available in this community, contact your insurance agent or call the National Flood Insurance Program at 1-800-638-6620.

**MAP SCALE 1" = 500'**

**NATIONAL FLOOD INSURANCE PROGRAM**

**PANEL 2158G**

**FIRM**  
**FLOOD INSURANCE RATE MAP**  
**SAN DIEGO COUNTY,**  
**CALIFORNIA**  
**AND INCORPORATED AREAS**

**PANEL 2158 OF 2375**  
(SEE MAP INDEX FOR FIRM PANEL LAYOUT)

**CONTAINS**

COMMUNITY	NUMBER	PANEL	SUFFIX
CHULA VISTA, CITY OF	06501	2158	G
SAN DIEGO, CITY OF	06025	2158	G

**ANNOTATED FIRM**

Notice to User: The Map Number shown below should be used when placing map orders; the Community Number shown above should be used on insurance applications for the subject community.

**MAP NUMBER**  
**06073C2158G**

**MAP REVISED**  
**MAY 16, 2012**

**Federal Emergency Management Agency**

# Grant Deed

DOC # 2004-0777337



AUG 16, 2004 2:59 PM

OFFICIAL RECORDS  
SAN DIEGO COUNTY RECORDER'S OFFICE  
GREGORY J. SMITH, COUNTY RECORDER  
FEES: 1068.50  
OC: AFNF  
PAGES: 2



2004-0777337

RECORDING REQUESTED BY:

*Handwritten: handle Commercial*

*Handwritten: 16 28 00 11*

When Recorded Mail Document and Tax Statement To:

Pardee Construction Company  
c/o Jon Lash  
10880 Wilshire Blvd. Ste. 1900  
Los Angeles, Ca. 90024

*Handwritten: 13994*

Escrow No. 980125  
Title Order No. 03202882-609-611

APN: GRANT DEED

The undersigned grantor(s) declare(s)

Documentary transfer tax is \$ 1,028.50 City tax \$ \_\_\_\_\_

- computed on full value of property conveyed, or
- computed on full value less value of liens or encumbrances remaining at time of sale,
- Unincorporated Area City of Chula Vista

FOR A VALUABLE CONSIDERATION, receipt of which is hereby acknowledged,

Mitsuro Nakano, Trustee U.D.T. April 7, 1995 and Tomio Nakano and Minako Nakano, Trustees U.D.T. April 12, 1995 hereby GRANT(S) to Pardee Homes, a California Corporation

the following described real property in the City of Chula Vista State of California: County of San Diego

That portion of the Northeast quarter of the Southeast quarter of Section 24, Township 18 South, Range 2 West, San Bernardino Meridian in the City of Chula Vista, County of San Diego, State of California, as more particularly described on the attached Exhibit 'A' made a part hereof.

DATED: May 12, 2004

STATE OF CALIFORNIA  
COUNTY OF San Diego

ON August 16, 2004 before me,  
A.V. Davies personally appeared  
Mitsuro Nakano, Tomio Nakano,  
Minako Nakano

personally known to me (or proved to me on the basis of satisfactory evidence) to be the person(s) whose name(s) is/are subscribed to the within instrument and acknowledged to me that he/she/they executed the same in his/her/their authorized capacity(ies), and that by his/her/their signature(s) on the instrument the person(s), or the entity upon behalf of which the person(s) acted, executed the instrument.

*Handwritten: Mitsuro Nakano*  
Mitsuro Nakano

*Handwritten: Tomio Nakano*  
Tomio Nakano

*Handwritten: Minako Nakano*  
Minako Nakano

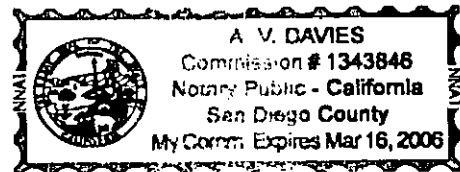

Witness my hand and official seal.

Signature *Handwritten: A.V. Davies*

MAIL TAX STATEMENT AS DIRECTED ABOVE

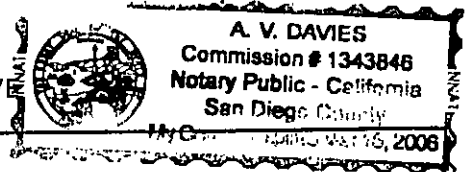

**EXHIBIT "A"**

All that certain real property situated in the County of San Diego, State of California, described as follows:

**PARCEL 1:**

That portion of the Northeast quarter of the Southeast quarter of Section 24, Township 18 South, Range 2 West, San Bernardino Meridian in the City of Chula Vista, County of San Diego, State of California, according to the Official Plat thereof described as follows:

Beginning at the Southeast corner of said Northeast quarter of the Southeast quarter, thence along the South line thereof South 89°42'04" West, 1069.30 feet to the Easterly line of freeway described in final order of condemnation recorded July 22, 1968 as File No. 123488 of Official Records; thence along said Easterly line North 3°47'10" East, 918.10 feet; thence North 80°52'26" East, 1030.62 feet to the East line of said Section; thence along said East line South 0°28'33" West, 1074.02 feet to the point of beginning.

**PARCEL 2:**

An easement for road and water pipeline purposes 15 feet wide along the existing traveled road across the Southeast quarter of the Northeast quarter and that portion of the Northeast quarter of the Southeast quarter of said section lying Northerly of the Northerly line of Parcel 1 above.

**EXCEPTING** that portion lying within said Freeway and Otay Valley Road.

Assessor's Parcel Number:       **624-071-02**



**MT-1 Form 2**  
**Elevation Form**

DEPARTMENT OF HOMELAND SECURITY - FEDERAL EMERGENCY MANAGEMENT AGENCY  
**ELEVATION FORM**

O.M.B. NO. 1660-0015  
 Expires February 28, 2014

**PAPERWORK BURDEN DISCLOSURE NOTICE**

Public reporting burden for this data collection is estimated to average 1.25 hours per response. The burden estimate includes the time for reviewing instructions, searching existing data sources, gathering and maintaining the needed data, and completing and submitting the form. This collection is required to obtain or retain benefits. You are not required to respond to this collection of information unless a valid OMB control number is displayed on this form. Send comments regarding the accuracy of the burden estimate and any suggestions for reducing this burden to: Information Collections Management, Department of Homeland Security, Federal Emergency Management Agency, 1800 South Bell Street, Arlington, VA 20598-3005, Paperwork Reduction Project (1660-0015). **NOTE: Do not send your completed form to this address.**

This form must be completed for requests and must be completed and signed by a registered professional engineer or licensed land surveyor. A DHS - FEMA National Flood Insurance Program (NFIP) Elevation Certificate may be submitted in lieu of this form for single structure requests.

For requests to remove a structure on natural grade OR on engineered fill from the Special Flood Hazard Area (SFHA), submit the lowest adjacent grade (the lowest ground touching the structure), **including an attached deck or garage**. For requests to remove an entire parcel of land from the SFHA, provide the lowest lot elevation; or, if the request involves an area described by metes and bounds, provide the lowest elevation within the metes and bounds description. All measurements are to be rounded to nearest tenth of a foot. In order to process your request, all information on this form must be completed **in its entirety**. Incomplete submissions will result in processing delays.

- NFIP Community Number: 060521 Property Name or Address: Nakano (North of intersection of Dennerly Rd. & Regatta Lane, Chula Vista, CA)
- Are the elevations listed below based on  existing or  proposed conditions? (Check one)
- For the existing or proposed structures listed below, what are the types of construction? (check all that apply)  
 crawl space  slab on grade  basement/enclosure  other (explain)
- Has DHS - FEMA identified this area as subject to land subsidence or uplift? (see instructions)  Yes  No  
 If yes, what is the date of the current re-leveling? / (month/year)
- What is the elevation datum?  NGVD 29  NAVD 88  Other (explain)  
 If any of the elevations listed below were computed using a datum different than the datum used for the effective Flood Insurance Rate Map (FIRM) (e.g., NGVD 29 or NAVD 88), what was the conversion factor? 2.17  
 Local Elevation +/- ft. = FIRM Datum
- Please provide the Latitude and Longitude of the most upstream edge of the **structure** (in decimal degrees to the nearest fifth decimal place):  
 Indicate Datum:  WGS84  NAD83  NAD27 Lat. . Long. .  
 Please provide the Latitude and Longitude of the most upstream edge of the **property** (in decimal degrees to the nearest fifth decimal place):  
 Indicate Datum:  WGS84  NAD83  NAD27 Lat. 32.59048 Long. 117.03231

Address	Lot Number	Block Number	Lowest Lot Elevation*	Lowest Adjacent Grade To Structure	Base Flood Elevation	BFE Source
624-071-02-00 Chula Vista, CA		N/A	95.7		92.7	FIRM 06073C2158G (Zone AE)

This certification is to be signed and sealed by a licensed land surveyor, registered professional engineer, or architect authorized by law to certify elevation information. All documents submitted in support of this request are correct to the best of my knowledge. I understand that any false statement may be punishable by fine or imprisonment under Title 18 of the United States Code, Section 1001.

Certifier's Name: Chelisa Pack	License No.: C71026	Expiration Date: 06/30/2021
Company Name: Project Design Consultants	Telephone No.: 619.235.5471	<div style="border: 2px solid black; width: 100%; height: 100%; display: flex; align-items: center; justify-content: center;">                 Seal (optional)             </div>
Email: chelisap@projectdesign.com	Fax No.: 619.234.0349	
Signature: 	Date: 5/19/2020	

\* For requests involving a portion of property, include the lowest ground elevation within the metes and bounds description.  
 Please note: If the Lowest Adjacent Grade to Structure is the only elevation provided, a determination will be issued for the structure only.

## **APPENDIX 2**

### **Exhibits**





FIRM MSE = 83.8 (NGVD29)

FIRM MSE = 88.8 (NGVD29)

FIRM MSE = 91.8 (NGVD29)

FIRM MSE = 93.8 (NGVD29)

DAVIES PARCEL - APN 624-071-01  
 P.R. NO. 203066324 DATED 5/10/2002

NAKANO PARCEL - APN 624-071-02  
 P.R. NO. 203066392 DATED 5/3/2002

LOWEST ELEVATION  
 ALONG NORTH PROPERTY  
 LINE = 95.7

LIMITS OF FEMA 100-YEAR  
 FLOODWAY PER FIRM  
 06073C2158C

LIMITS OF FEMA 100-YEAR  
 FLOODPLAIN PER FIRM  
 06073C2158C

HIGHEST BFE = 92.7  
 (INTERPOLATED)

PROPERTY BOUNDARY

PROPERTY BOUNDARY

INTERSTATE 805

DENNERLY VILLAGES 2/3

DENNERLY ROAD

LOT 'B'

LOT

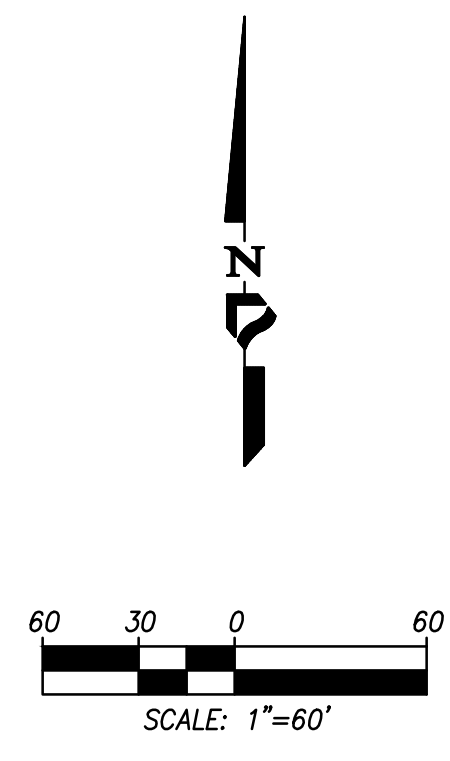

**LEGEND:**

	PROPERTY BOUNDARY
	EXISTING ZONE AE FLOODPLAIN



**TOPOGRAPHY SOURCE**  
 ONSITE TOPOGRAPHY SHOWN IS BASED UPON AN AERIAL SURVEY BY: PROJECT DESIGN CONSULTANTS, IN DECEMBER 2019. VERTICAL DATUM OF TOPOGRAPHY AS SHOWN ON THIS EXHIBIT IS NGVD29.

SCALE: 1"=60'  
 JOB #: 4409.02  
 CREATED: 4/2/20

PREPARED BY:  
  
**PROJECT DESIGN CONSULTANTS**  
 Planning | Landscape Architecture | Environmental | Engineering | Survey  
 701 B Street, Suite 800 San Diego, CA 92101  
 619.235.6471 Tel 619.234.0349 Fax

**CITY OF CHULA VISTA**  
**NAKANO**  
 EXISTING CONDITIONS FEMA FLOOD MAP  
 LETTER OF MAP AMENDMENT  
 EXHIBIT A-1

## **APPENDIX 7**

### **FEMA Approval Letter for LOMA**



# Federal Emergency Management Agency

Washington, D.C. 20472

## LETTER OF MAP AMENDMENT DETERMINATION DOCUMENT (REMOVAL)

COMMUNITY AND MAP PANEL INFORMATION		LEGAL PROPERTY DESCRIPTION
COMMUNITY	CITY OF CHULA VISTA, SAN DIEGO COUNTY, CALIFORNIA	A portion of Section 24, Township 18 South, Range 2 West, San Bernardino Meridian, as described in the Grant Deed recorded as Document No. 2004-0777337, Pages 13994 and 13995, in the Office of the County Recorder, San Diego County, California (APN: 624-071-02)
	COMMUNITY NO.: 065021	
AFFECTED MAP PANEL	NUMBER: 06073C2158G DATE: 5/16/2012	
FLOODING SOURCE: OTAY RIVER		APPROXIMATE LATITUDE & LONGITUDE OF PROPERTY: 32.588896, -117.033960 SOURCE OF LAT & LONG: LOMA LOGIC DATUM: NAD 83

### DETERMINATION

LOT	BLOCK/ SECTION	SUBDIVISION	STREET	OUTCOME WHAT IS REMOVED FROM THE SFHA	FLOOD ZONE	1% ANNUAL CHANCE FLOOD ELEVATION (NAVD 88)	LOWEST ADJACENT GRADE ELEVATION (NAVD 88)	LOWEST LOT ELEVATION (NAVD 88)
--	--	--	--	Property	X (shaded)	--	--	97.9 feet

**Special Flood Hazard Area (SFHA)** - The SFHA is an area that would be inundated by the flood having a 1-percent chance of being equaled or exceeded in any given year (base flood).

**ADDITIONAL CONSIDERATIONS** (Please refer to the appropriate section on Attachment 1 for the additional considerations listed below.)

STATE LOCAL CONSIDERATIONS

This document provides the Federal Emergency Management Agency's determination regarding a request for a Letter of Map Amendment for the property described above. Using the information submitted and the effective National Flood Insurance Program (NFIP) map, we have determined that the property(ies) is/are not located in the SFHA, an area inundated by the flood having a 1-percent chance of being equaled or exceeded in any given year (base flood). This document amends the effective NFIP map to remove the subject property from the SFHA located on the effective NFIP map; therefore, the Federal mandatory flood insurance requirement does not apply. However, the lender has the option to continue the flood insurance requirement to protect its financial risk on the loan. A Preferred Risk Policy (PRP) is available for buildings located outside the SFHA. Information about the PRP and how one can apply is enclosed.

This determination is based on the flood data presently available. The enclosed documents provide additional information regarding this determination. If you have any questions about this document, please contact the FEMA Map Information eXchange (FMIX) toll free at (877) 336-2627 (877-FEMA MAP) or by letter addressed to the Federal Emergency Management Agency, Engineering Library, 3601 Eisenhower Ave Ste 500, Alexandria, VA 22304-6426.

Luis V. Rodriguez, P.E., Director  
Engineering and Modeling Division  
Federal Insurance and Mitigation Administration



# Federal Emergency Management Agency

Washington, D.C. 20472

## LETTER OF MAP AMENDMENT DETERMINATION DOCUMENT (REMOVAL)

ATTACHMENT 1 (ADDITIONAL CONSIDERATIONS)

### STATE AND LOCAL CONSIDERATIONS (This Additional Consideration applies to all properties in the LOMA DETERMINATION DOCUMENT (REMOVAL))

Please note that this document does not override or supersede any State or local procedural or substantive provisions which may apply to floodplain management requirements associated with amendments to State or local floodplain zoning ordinances, maps, or State or local procedures adopted under the National Flood Insurance Program.

This attachment provides additional information regarding this request. If you have any questions about this attachment, please contact the FEMA Map Information eXchange (FMIX) toll free at (877) 336-2627 (877-FEMA MAP) or by letter addressed to the Federal Emergency Management Agency, Engineering Library, 3601 Eisenhower Ave Ste 500, Alexandria, VA 22304-6426.

A handwritten signature in black ink, appearing to read "Luis V. Rodriguez".

Luis V. Rodriguez, P.E., Director  
Engineering and Modeling Division  
Federal Insurance and Mitigation Administration



# Federal Emergency Management Agency

Washington, D.C. 20472

**May 22, 2020**

MS. CHELISA PACK  
PROJECT DESIGN CONSULTANTS  
701 B STREET  
SUITE 800  
SAN DIEGO, CA 92101

**CASE NO.: 20-09-1145A**  
COMMUNITY: CITY OF CHULA VISTA, SAN DIEGO  
COUNTY, CALIFORNIA  
COMMUNITY NO.: 065021

DEAR MS. PACK:

This is in reference to a request that the Federal Emergency Management Agency (FEMA) determine if the property described in the enclosed document is located within an identified Special Flood Hazard Area, the area that would be inundated by the flood having a 1-percent chance of being equaled or exceeded in any given year (base flood), on the effective National Flood Insurance Program (NFIP) map. Using the information submitted and the effective NFIP map, our determination is shown on the attached Letter of Map Amendment (LOMA) Determination Document. This determination document provides additional information regarding the effective NFIP map, the legal description of the property and our determination.

Additional documents are enclosed which provide information regarding the subject property and LOMAs. Please see the List of Enclosures below to determine which documents are enclosed. Other attachments specific to this request may be included as referenced in the Determination/Comment document. If you have any questions about this letter or any of the enclosures, please contact the FEMA Map Information eXchange (FMIX) toll free at (877) 336-2627 (877-FEMA MAP) or by letter addressed to the Federal Emergency Management Agency, Engineering Library, 3601 Eisenhower Ave Ste 500, Alexandria, VA 22304-6426.

Sincerely,

Luis V. Rodriguez, P.E., Director  
Engineering and Modeling Division  
Federal Insurance and Mitigation Administration

**LIST OF ENCLOSURES:**

LOMA DETERMINATION DOCUMENT (REMOVAL)

cc: State/Commonwealth NFIP Coordinator  
Community Map Repository  
Region



# Federal Emergency Management Agency

Washington, D.C. 20472

## **ADDITIONAL INFORMATION REGARDING LETTERS OF MAP AMENDMENT**

When making determinations on requests for Letters of Map Amendment (LOMAs), the Department of Homeland Security's Federal Emergency Management Agency (FEMA) bases its determination on the flood hazard information available at the time of the determination. Requesters should be aware that flood conditions may change or new information may be generated that would supersede FEMA's determination. In such cases, the community will be informed by letter.

Requesters also should be aware that removal of a property (parcel of land or structure) from the Special Flood Hazard Area (SFHA) means FEMA has determined the property is not subject to inundation by the flood having a 1-percent chance of being equaled or exceeded in any given year (base flood). This does not mean the property is not subject to other flood hazards. The property could be inundated by a flood with a magnitude greater than the base flood or by localized flooding not shown on the effective National Flood Insurance Program (NFIP) map.

The effect of a LOMA is it removes the Federal requirement for the lender to require flood insurance coverage for the property described. The LOMA *is not* a waiver of the condition that the property owner maintain flood insurance coverage for the property. *Only* the lender can waive the flood insurance purchase requirement because the lender imposed the requirement. *The property owner must request and receive a written waiver from the lender before canceling the policy.* The lender may determine, on its own as a business decision, that it wishes to continue the flood insurance requirement to protect its financial risk on the loan.

The LOMA provides FEMA's comment on the mandatory flood insurance requirements of the NFIP as they apply to a particular property. A LOMA is not a building permit, nor should it be construed as such. Any development, new construction, or substantial improvement of a property impacted by a LOMA must comply with all applicable State and local criteria and other Federal criteria.

If a lender releases a property owner from the flood insurance requirement, and the property owner decides to cancel the policy and seek a refund, the NFIP will refund the premium paid for the current policy year, provided that no claim is pending or has been paid on the policy during the current policy year. The property owner must provide a written waiver of the insurance requirement from the lender to the property insurance agent or company servicing his or her policy. The agent or company will then process the refund request.

Even though structures are not located in an SFHA, as mentioned above, they could be flooded by a flooding event with a greater magnitude than the base flood. In fact, more than 25 percent of all claims paid by the NFIP are for policies for structures located outside the SFHA in Zones B, C, X (shaded), or X (unshaded). More than one-fourth of all policies purchased under the NFIP protect structures located in these zones. The risk to structures located outside SFHAs is just not as great as the risk to structures located in SFHAs. Finally, approximately 90 percent of all federally declared disasters are caused by flooding, and homeowners insurance does not provide financial protection from this flooding. Therefore, FEMA encourages the widest possible coverage under the NFIP.

The NFIP offers two types of flood insurance policies to property owners: the low-cost Preferred Risk Policy (PRP) and the Standard Flood Insurance Policy (SFIP). The PRP is available for 1- to 4-family residential structures located outside the SFHA with little or no loss history. The PRP is available for townhouse/rowhouse-type structures, but is not available for other types of condominium units. The SFIP is available for all other structures. Additional information on the PRP and how a property owner can qualify for this type of policy may be obtained by calling the Flood Insurance Information Hotline, toll free, at 1-800-427-4661. Before making a final decision about flood insurance coverage, FEMA strongly encourages property owners to discuss their individual flood risk situations and insurance needs with an insurance agent or company.

FEMA has established "Grandfather" rules to benefit flood insurance policyholders who have maintained continuous coverage. Property owners may wish to note also that, if they live outside but on the fringe of the SFHA shown on an effective NFIP map and the map is revised to expand the SFHA to include their structure(s), their flood insurance policy rates will not increase as long as the coverage for the affected structure(s) has been continuous. Property owners would continue to receive the lower insurance policy rates.

LOMAs are based on minimum criteria established by the NFIP. State, county, and community officials, based on knowledge of local conditions and in the interest of safety, may set higher standards for construction in the SFHA. If a State, county, or community has adopted more restrictive and comprehensive floodplain management criteria, these criteria take precedence over the minimum Federal criteria.

In accordance with regulations adopted by the community when it made application to join the NFIP, letters issued to amend an NFIP map must be attached to the community's official record copy of the map. That map is available for public inspection at the community's official map repository. Therefore, FEMA sends copies of all such letters to the affected community's official map repository.

When a restudy is undertaken, or when a sufficient number of revisions or amendments occur on particular map panels, FEMA initiates the printing and distribution process for the affected panels. FEMA notifies community officials in writing when affected map panels are being physically revised and distributed. In such cases, FEMA attempts to reflect the results of the LOMA on the new map panel. If the results of particular LOMAs cannot be reflected on the new map panel because of scale limitations, FEMA notifies the community in writing and revalidates the LOMAs in that letter. LOMAs revalidated in this way usually will become effective 1 day after the effective date of the revised map.

**Nakano**  
**LETTER OF MAP AMENDMENT**  
**(LOMA)**

FEMA, City of Chula Vista  
**May 18, 2020**

**FIRM # 06073C2158G**

Prepared For:

**Pardee Homes**  
13400 Sabre Springs Parkway, Suite 200  
San Diego, California 92128

Prepared By:



**PROJECT DESIGN CONSULTANTS**

Planning | Landscape Architecture | Environmental | Engineering | Survey

701 B Street, Suite 800  
San Diego, CA 92101  
619.235.6471 Tel  
619.234.0349 Fax

PDC Job No. 4409.02



Prepared by: J. Novoa, P.E.

*Under the supervision of:*

Chelisa Pack, PE RCE 71026  
Registration Expires 06/30/21



# TABLE OF CONTENTS

1.	INTRODUCTION .....	1
2.	SUMMARY OF METHODOLOGY .....	1
2.1	Existing Condition of the Property .....	1
2.2	Floodplain Base Flood Elevation Comparison .....	2
3.	CONCLUSIONS.....	2

## APPENDICES

1	FEMA Forms, Package MT-1
2	Exhibits

## **1. INTRODUCTION**

This Letter of Map Amendment (LOMA) has been prepared in order to certify that the existing property within the Nakano project in the City of Chula Vista, California is above the flood elevations as indicated on the NFIP map.

The purpose of the application is to demonstrate that the existing elevations of the Nakano property are above the flood elevations indicated by Zone AE as shown in the FIRM Panel No. 06073C2158G, effective date May 16, 2012. The Zone AE floodplain extends along the north portion of the site with water surface elevations ranging from 83.8 to 92.7 ft. MSL (NGVD 29). Note that there a 2.17 conversion from NAVD88 to NGVD29 datum. The elevations listed on the exhibit show elevations per the NGVD29 datum.

## **2. SUMMARY OF METHODOLOGY**

The following summarizes how the base flood elevations were determined in order to ensure the existing elevations are above the base flood and enable their removal from the special flood hazard area mapping.

### **2.1 Existing Condition of the Property**

The Nakano site consists of approximately 23.8 acres of existing hillside and grass land use located within the Otay Mesa neighborhood of the City of Chula Vista. The site is bounded by Kaiser Permanente medical offices to the South, Interstate 805 to the West, an existing residential site to the east and Otay River to the North. Existing condition onsite includes grassland, hillside, utilities facilities, and a small dirt paths traversing the property.

Per the FIRM panel, in the existing condition, the floodplain encroaches into the site along the northern extents of the project boundary. Along the northern portion of the property the site is affected by Zone AE. Refer to Exhibit A-1 for the existing floodplain exhibit depicting the relationship of the floodplain to the property.

## **2.2 Floodplain Base Flood Elevation Comparison**

The base flood elevations (BFE) were taken from the FEMA FIRM Panel No. 06073C2158G, effective date May 16, 2012. The Zone AE floodplain extends along the north portion of the site with water surface elevations ranging from 83.8 to 92.7 ft. MSL (NGVD 29). The lowest point on the site along the northern property line is 95.7, three feet above the highest floodplain elevation at the northwest corner of the site of 92.7. This comparison of the worst case scenario of the lowest elevation on the existing property is still three feet higher than the highest floodway elevation at any point on site indicates that the entire site can be removed from the special flood hazard area mapping.

## **3. CONCLUSIONS**

The existing property elevations indicate that the entire site is higher than the determined Zone AE special flood hazard area base flood elevations for the Otay River. Therefore, this report supports a recommendation that the entire property identified be removed from the 100-year floodplain limits.

**APPENDIX 1**  
**FEMA Forms, Package MT-1**

**MT-1 Form 1**  
**Property Information**

**PAPERWORK BURDEN DISCLOSURE NOTICE**

Public reporting burden for this data collection is estimated to average 1.63 hours per response. The burden estimate includes the time for reviewing instructions, searching existing data sources, gathering and maintaining the needed data, and completing and submitting the form. This collection is required to obtain or retain benefits. You are not required to respond to this collection of information unless a valid OMB control number is displayed on this form. Send comments regarding the accuracy of the burden estimate and any suggestions for reducing this burden to: Information Collections Management, Department of Homeland Security, Federal Emergency Management Agency, 1800 South Bell Street, Arlington, VA 20598-3005, Paperwork Reduction Project (1660-0015). **NOTE: Do not send your completed form to this address.**

This form may be completed by the property owner, property owner's agent, licensed land surveyor, or registered professional engineer to support a request for a Letter of Map Amendment (LOMA), Conditional Letter of Map Amendment (CLOMA), Letter of Map Revision Based on Fill (LOMR-F), or Conditional Letter of Map Revision Based on Fill (CLOMR-F) for existing or proposed, single or multiple lots/structures. In order to process your request, all information on this form must be completed *in its entirety*, unless stated as optional. **Incomplete submissions will result in processing delays.** Please check the item below that describes your request:

<input type="checkbox"/> LOMA	A letter from DHS-FEMA stating that an existing structure or parcel of land that has not been elevated by fill (natural grade) would not be inundated by the base flood.
<input type="checkbox"/> CLOMA	A letter from DHS-FEMA stating that a proposed structure that is not to be elevated by fill (natural grade) would not be inundated by the base flood if built as proposed.
<input type="checkbox"/> LOMR-F	A letter from DHS-FEMA stating that an <b>existing</b> structure or parcel of land that has been <b>elevated by fill</b> would not be inundated by the base flood.
<input type="checkbox"/> CLOMR-F	A letter from DHS-FEMA stating that a parcel of land or <b>proposed</b> structure that will be <b>elevated by fill</b> would not be inundated by the base flood if fill is placed on the parcel as proposed or the structure is built as proposed.

**Fill** is defined as material from any source (including the subject property) placed that raises the ground to or above the Base Flood Elevation (BFE). The common construction practice of removing unsuitable existing material (topsoil) and backfilling with select structural material is not considered the placement of fill if the practice does not alter the existing (natural grade) elevation, which is at or above the BFE. **Fill that is placed before the date of the first National Flood Insurance Program (NFIP) map showing the area in a Special Flood Hazard Area (SFHA) is considered natural grade.**

Has fill been placed on your property to raise ground that was previously below the BFE?  Yes  No      If yes, when was fill placed? \_\_\_\_\_ / \_\_\_\_\_ month/year

Will fill be placed on your property to raise ground that is below the BFE?  Yes\*  No      If yes, when will fill be placed? \_\_\_\_\_ / \_\_\_\_\_ month/year

\* If yes, Endangered Species Act (ESA) compliance must be documented to FEMA prior to issuance of the CLOMR-F determination (please refer page 4 to the MT-1 instructions).

- Street Address of the Property (if request is for multiple structures or units, please attach additional sheet referencing each address and enter street names below):
- Legal description of Property (Lot, Block, Subdivision or abbreviated description from the Deed):
- Are you requesting that a flood zone determination be completed for (check one):
  - Structures on the property? What are the dates of construction? \_\_\_\_\_ (MM/YYYY)
  - A portion of land within the bounds of the property? (A certified metes and bounds description and map of the area to be removed, certified by a licensed land surveyor or registered professional engineer, are **required**. For the preferred format of metes and bounds descriptions, please refer to the MT-1 Form 1 Instructions.)
  - The entire legally recorded property?
- Is this request for a (check one):
  - Single structure
  - Single lot
  - Multiple structures (How many structures are involved in your request? List the number: \_\_\_\_\_)
  - Multiple lots (How many lots are involved in your request? List the number: \_\_\_\_\_)

In addition to this form (MT-1 Form 1), please complete the checklist below. ALL requests must include one copy of the following:

- Copy of the effective FIRM panel on which the structure and/or property location has been accurately plotted (property inadvertently located in the NFIP regulatory floodway will require Section B of MT-1 Form 3)
- Copy of the Subdivision Plat Map for the property (with recordation data and stamp of the Recorder's Office)  
OR
- Copy of the Property Deed (with recordation data and stamp of the Recorder's Office), accompanied by a tax assessor's map or other certified map showing the surveyed location of the property relative to local streets and watercourses. The map should include at least one street intersection that is shown on the FIRM panel.
- Form 2 – Elevation Form. If the request is to remove the structure, and an Elevation Certificate has already been completed for this property, it may be submitted in lieu of Form 2. If the request is to remove the entire legally recorded property, or a portion thereof, the lowest lot elevation must be provided on Form 2.
- Please include a map scale and North arrow on all maps submitted.

For LOMR-Fs and CLOMR-Fs, the following must be submitted in addition to the items listed above:

- Form 3 – Community Acknowledgment Form

For CLOMR-Fs, the following must be submitted in addition to the items listed above:

- Documented ESA compliance, which may include a copy of an Incidental Take Permit, an Incidental Take Statement, a "not likely to adversely affect" determination from the National Marine Fisheries Service (NMFS) or the U.S. Fish and Wildlife Service (USFWS), or an official letter from NMFS or USFWS concurring that the project has "No Effect" on proposed or listed species or designated critical habitat. Please refer to the MT-1 instructions for additional information.

Please do *not* submit original documents. Please retain a copy of all submitted documents for your records.

DHS-FEMA encourages the submission of all required data in a digital format (e.g. scanned documents and images on Compact Disc [CD]). Digital submissions help to further DHS-FEMA's Digital Vision and also may facilitate the processing of your request.

Incomplete submissions will result in processing delays. For additional information regarding this form, including where to obtain the supporting documents listed above, please refer to the MT-1 Form Instructions located at [http://www.fema.gov/plan/prevent/fhm/dl\\_mt-1.shtm](http://www.fema.gov/plan/prevent/fhm/dl_mt-1.shtm).

**Processing Fee** (see instructions for appropriate mailing address; or visit [http://www.fema.gov/fhm/frm\\_fees.shtm](http://www.fema.gov/fhm/frm_fees.shtm) for the most current fee schedule)

Revised fee schedules are published periodically, but no more than once annually, as noted in the **Federal Register**. Please note: single/multiple lot(s)/structure(s) LOMAs are fee exempt. The current review and processing fees are listed below:

Check the fee that applies to your request:

- \$325 (single lot/structure LOMR-F following a CLOMR-F)
- \$425 (single lot/structure LOMR-F)
- \$500 (single lot/structure CLOMA or CLOMR-F)
- \$700 (multiple lot/structure LOMR-F following a CLOMR-F, or multiple lot/structure CLOMA)
- \$800 (multiple lot/structure LOMR-F or CLOMR-F)

Please submit the Payment Information Form for remittance of applicable fees. Please make your check or money order payable to:  
**National Flood Insurance Program.**

All documents submitted in support of this request are correct to the best of my knowledge. I understand that any false statement may be punishable by fine or imprisonment under Title 18 of the United States Code, Section 1001.

Applicant's Name (required): Chelisa Pack

Company (if applicable): Project Design Consultants

Mailing Address (required):

701 B St., Suite 800, San Diego, CA 92101

Daytime Telephone No. (required): (619) 235-6471

E-Mail Address (optional):  By checking here you may receive correspondence electronically at the email address provided):

Fax No. (optional): (619) 234-0349

chelisap@projectdesign.com

Date (required)

4/7/2020



Signature of Applicant (required)

## LEGAL DESCRIPTION

### PARCEL 1:

THAT PORTION OF THE NORTHEAST QUARTER OF THE SOUTHWEST QUARTER OF SECTION 24, TOWNSHIP 18 SOUTH, RANGE 2 WEST, SAN BERNARDINO MERIDIAN IN THE CITY OF CHULA VISTA, COUNTY OF SAN DIEGO, STATE OF CALIFORNIA, ACCORDING TO THE OFFICIAL PLAT THEREOF DESCRIBED AS FOLLOWS:

BEGINNING AT THE SOUTHEAST CORNER OF SAID NORTHEAST QUARTER OF THE SOUTHEAST QUARTER; THENCE ALONG THE SOUTH LINE THEREOF SOUTH 89°42'04" WEST, 1069.30 FEET TO THE EASTERLY LINE OF FREEWAY DESCRIBED IN FINAL ORDER OF CONDEMNATION RECORDED JULY 22, 1968 AS FILE NO. 123499 OFFICAL RECORDS; THENCE ALONG SAID EASTERLY LINE NORTH 3°47'10" EAST, 918.10 FEET; THENCE NORTH 80°52'26" EAST, 1030.62 FEET TO THE EAST LINE OF SAID SECTION: THENCE ALONG SAID EAST LINE SOUTH 0°28'33" WEST, 1074.02 FEET TO THE POINT OF BEGINNING.

### PARCEL 2:

AN EASEMENT FOR ROAD AND WATER PIPELINE PURPOSES 15 FEET WIDE ALONG THE EXSTING TRAVELED ROAD ACROSS THE SOUTHEAST QUARTER OF THE NORTHEAST QUARTER AND THAT PORTION OF THE NORTHEAST QUARTER OF THE SOUTHEAST QUARTER OF SAID SECTION LYING NORTHERLY OF THE NORTHERLY LINE OF PARCEL 1 ABOVE.

EXCEPTING THAT PORTION LYING WITHIN SAID FREEWAY AND OTAY VALLEY ROAD.



## **Annotated FIRM Panel**

**NOTES TO USERS**

This map is for use in administering the National Flood Insurance Program. It does not necessarily identify all areas subject to flooding, particularly from local drainage sources of small size. The community map repository should be consulted for possible updated or additional flood hazard information.

To obtain more detailed information in areas where **Base Flood Elevations (BFEs)** and/or **Floodway Data** have been determined, users are encouraged to consult the Flood Profiles and Floodway Data and/or Summary of Stillwater Elevations tables contained within the Flood Insurance Study (FIS) report that accompanies this FIRM. Users should be aware that BFEs shown on the FIRM represent rounded whole-foot elevations. These BFEs are intended for flood insurance rating purposes only and should not be used as the sole source of flood elevation information. Accordingly, flood elevation data presented in the FIS report should be utilized in conjunction with the FIRM for purposes of construction and/or floodplain management.

**Coastal Base Flood Elevations (CBEs)** shown on this map apply only to landward of 0.0' North American Vertical Datum of 1988 (NAVD 88). Users of this FIRM should be aware that coastal flood elevations are also provided in the Summary of Stillwater Elevations table in the Flood Insurance Study report for this jurisdiction. Elevations shown in the Summary of Stillwater Elevations table should be used for construction and/or floodplain management purposes when they are higher than the elevations shown on this FIRM.

Boundaries of the floodways were computed at cross sections and interpolated between cross sections. The floodways were based on hydraulic considerations with regard to requirements of the National Flood Insurance Program. Floodway widths and other pertinent floodway data are provided in the Flood Insurance Study report for this jurisdiction.

Certain areas not in Special Flood Hazard Areas may be protected by **flood control structures**. Refer to Section 2.4 "Flood Protection Measures" of the Flood Insurance Study report for information on flood control structures for this jurisdiction.

The projection used in the preparation of this map was Universal Transverse Mercator (UTM) Zone 11. The horizontal datum was NAD83, GRS1980 spheroid. Differences in datum, spheroid, projection or UTM zones used in the production of FIRMs for adjacent jurisdictions may result in slight positional differences in map features across jurisdiction boundaries. These differences do not affect the accuracy of this FIRM.

Flood elevations on this map are referenced to the North American Vertical Datum of 1988. These flood elevations must be compared to structure and ground elevations referenced to the same vertical datum. For information regarding conversion between the National Geodetic Vertical Datum of 1929 and the North American Vertical Datum of 1988, visit the National Geodetic Survey website at <http://www.ngs.noaa.gov> or contact the National Geodetic Survey at the following address:

NGS Information Services  
NCA, NINGS12  
National Geodetic Survey  
SSMC-3, #9202  
1315 East-West Highway  
Silver Spring, Maryland 20910-3282  
(301) 713-3242

To obtain current elevation, description, and/or location information for **bench marks** shown on this map, please contact the Information Services Branch of the National Geodetic Survey at (301) 713-3242 or visit its website at <http://www.ngs.noaa.gov/>.

**Base map** information shown on this FIRM was provided in digital format by the USDA National Agriculture Imagery Program (NAIP). This information was photogrammetrically compiled at a scale of 1:24,000 from aerial photography dated 2009.

This map reflects more detailed and up-to-date stream channel configurations and floodways than those shown on the previous FIRM for this jurisdiction. The floodplains and floodways that were transferred from the previous FIRM may have been adjusted to conform to these new stream channel configurations. As a result, the Flood Profiles and Floodway Data tables in the Flood Insurance Study report (which contains authoritative hydraulic data) may reflect stream channel distances that differ from what is shown on this map.

**Corporate limits** shown on this map are based on the best data available at the time of publication. Because changes due to annexations or de-annexations may have occurred after this map was published, map users should contact appropriate community officials to verify current corporate limit locations.

Please refer to the separately printed **Map Index** for an overview map of the county showing the layout of map panels, community map repository addresses, and a Listing of Communities table containing National Flood Insurance Program dates for each community as well as a listing of the panels on which each community is located.

Contact the **FEMA Map Service Center** at 1-877-FEMA-MAP (1-877-336-2627) for information on available products associated with this FIRM. Available products may include previously issued Letters of Map Change, a Flood Insurance Study report, and/or digital versions of this map. The FEMA Map Service Center may also be reached by fax at 1-800-356-9620 and its website at <http://msc.fema.gov/>.

If you have questions about this map or questions concerning the National Flood Insurance Program in general, please call 1-877-FEMA-MAP (1-877-336-2627) or visit the FEMA website at <http://www.fema.gov/business/nfp/>.

The "profile base lines" depicted on this map represent the hydraulic modeling baselines that match the flood profiles in the FIS report. As a result of improved topographic data, the "profile base line", in some cases, may deviate significantly from the channel centerline or appear outside the SFHA.

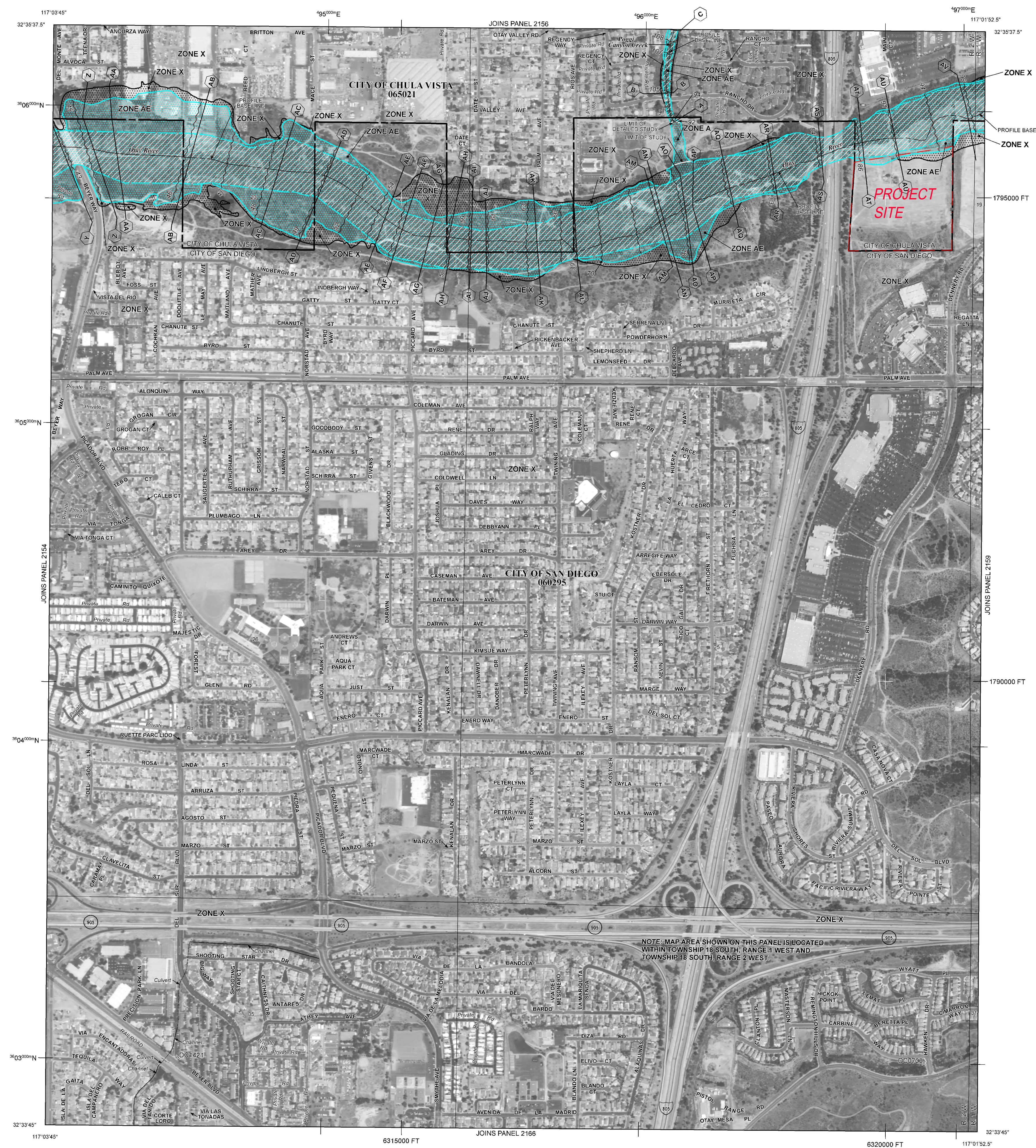

**LEGEND**

**SPECIAL FLOOD HAZARD AREAS SUBJECT TO INUNDATION BY THE 1% ANNUAL CHANCE FLOOD**

The 1% annual chance flood (100-year flood), also known as the base flood, is the flood that has a 1% chance of being equaled or exceeded in any given year. The Special Flood Hazard Area is the area subject to flooding by the 1% annual chance flood. Areas of Special Flood Hazard include Zones A, AE, AH, AO, AR, A99, V, and VE. The Base Flood Elevation is the water-surface elevation of the 1% annual chance flood.

- ZONE A** No Base Flood Elevations determined.
- ZONE AE** Base Flood Elevations determined.
- ZONE AH** Flood depths of 1 to 3 feet (usually areas of ponding); Base Flood Elevations determined.
- ZONE AO** Flood depths of 1 to 3 feet (usually shelf flow on sloping terrain); average depths determined. For areas of alluvial fan flooding, velocities also determined.
- ZONE AR** Special Flood Hazard Area formerly protected from the 1% annual chance flood by a flood control system that was subsequently destroyed. Zone AR indicates that the former flood control system is being restored to provide protection from the 1% annual chance or greater flood.
- ZONE A99** Areas to be protected from 1% annual chance flood event by a Federal flood protection system under construction; no Base Flood Elevations determined.
- ZONE V** Coastal flood zone with velocity hazard (wave action); no Base Flood Elevations determined.
- ZONE VE** Coastal flood zone with velocity hazard (wave action); Base Flood Elevations determined.

**FLOODWAY AREAS IN ZONE AE**

The floodway is the channel of a stream plus any adjacent floodplain areas that must be kept free of encroachment so that the 1% annual chance flood can be carried without substantial increases in flood heights.

**OTHER FLOOD AREAS**

- ZONE X** Areas of 0.2% annual chance flood; areas of 1% annual chance flood with average depths of less than 1 foot or with drainage areas less than 1 square mile; and areas protected by levees from 1% annual chance flood.

**OTHER AREAS**

- ZONE D** Areas determined to be outside the 0.2% annual chance floodplain.
- ZONE F** Areas in which flood hazards are undetermined, but possible.

**COASTAL BARRIER RESOURCES SYSTEM (CBRS) AREAS**

**OTHERWISE PROTECTED AREAS (OPAs)**

CBRS areas and OPAs are normally located within or adjacent to Special Flood Hazard Areas.

- 1% annual chance floodplain boundary
- 0.2% annual chance floodplain boundary
- Floodway boundary
- Floodway boundary
- Zone D boundary
- Zone F boundary
- CBRS and OPA boundary
- Boundary dividing Special Flood Hazard Area Zones and boundary dividing Special Flood Hazard Areas of different Base Flood Elevations, flood depths, or flood velocities
- Base Flood Elevation line and value; elevation in feet\*
- Base Flood Elevation value where uniform within zone; elevation in feet\*

\* Referenced to the North American Vertical Datum of 1988

**MAP REPOSITORIES**

Refer to Map Repositories list on Map Index.

**EFFECTIVE DATE OF COUNTYWIDE FLOOD INSURANCE RATE MAP**

June 19, 1997

**EFFECTIVE DATE(S) OF REVISION(S) TO THIS PANEL**

May 16, 2012 - to update corporate limits, to add roads and road names, to incorporate previously issued Letters of Map Revision, and to update map elevations to North American Vertical Datum of 1988.

For community map revision history prior to countywide mapping, refer to the Community Map History table located in the Flood Insurance Study report for this jurisdiction.

To determine if flood insurance is available in this community, contact your insurance agent or call the National Flood Insurance Program at 1-800-638-6620.

**MAP SCALE 1" = 500'**

250 0 250 500 750 1,000  
150 0 150 300  
FEET METERS

**NATIONAL FLOOD INSURANCE PROGRAM**

**PANEL 2158G**

**FIRM**

**FLOOD INSURANCE RATE MAP**

**SAN DIEGO COUNTY, CALIFORNIA AND INCORPORATED AREAS**

**PANEL 2158 OF 2375**

(SEE MAP INDEX FOR FIRM PANEL LAYOUT)

**CONTAINS**

COMMUNITY	NUMBER	PANEL	SUFFIX
CHULA VISTA, CITY OF	06501	2158	G
SAN DIEGO, CITY OF	06025	2158	G

**ANNOTATED FIRM**

Notice to User: The Map Number shown should be used when placing map orders; the Community Number shown above should be used on insurance applications for the subject community.

**MAP NUMBER 06073C2158G**

**MAP REVISED MAY 16, 2012**

**Federal Emergency Management Agency**

# **Grant Deed**

DOC # 2004-0777337



AUG 16, 2004 2:59 PM

OFFICIAL RECORDS  
SAN DIEGO COUNTY RECORDER'S OFFICE  
GREGORY J. SMITH, COUNTY RECORDER  
FEES: 1068.50  
OC: AFNF  
PAGES: 2



2004-0777337

RECORDING REQUESTED BY:

*Handwritten: handle Commercial*

*Handwritten: 16 28 00 11*

When Recorded Mail Document and Tax Statement To:

Pardee Construction Company  
c/o Jon Lash  
10880 Wilshire Blvd. Ste. 1900  
Los Angeles, Ca. 90024

*Handwritten: 13994*

Escrow No. 980125  
Title Order No. 03202882-609-611

APN: GRANT DEED

The undersigned grantor(s) declare(s)

Documentary transfer tax is \$ 1,028.50 City tax \$ \_\_\_\_\_

- computed on full value of property conveyed, or
- computed on full value less value of liens or encumbrances remaining at time of sale,
- Unincorporated Area City of Chula Vista

FOR A VALUABLE CONSIDERATION, receipt of which is hereby acknowledged,

Mitsuro Nakano, Trustee U.D.T. April 7, 1995 and Tomio Nakano and Minako Nakano, Trustees U.D.T. April 12, 1995 hereby GRANT(S) to Pardee Homes, a California Corporation

the following described real property in the City of Chula Vista State of California: County of San Diego

That portion of the Northeast quarter of the Southeast quarter of Section 24, Township 18 South, Range 2 West, San Bernardino Meridian in the City of Chula Vista, County of San Diego, State of California, as more particularly described on the attached Exhibit 'A' made a part hereof.

DATED: May 12, 2004

STATE OF CALIFORNIA  
COUNTY OF San Diego  
ON August 16, 2004 before me,  
A.V. Davies personally appeared  
Mitsuro Nakano, Tomio Nakano,  
Minako Nakano

*Mitsuro Nakano*  
Mitsuro Nakano  
*Tomio Nakano*  
Tomio Nakano  
*Minako Nakano*  
Minako Nakano

personally known to me (or proved to me on the basis of satisfactory evidence) to be the person(s) whose name(s) is/are subscribed to the within instrument and acknowledged to me that he/she/they executed the same in his/her/their authorized capacity(ies), and that by his/her/their signature(s) on the instrument the person(s), or the entity upon behalf of which the person(s) acted, executed the instrument.

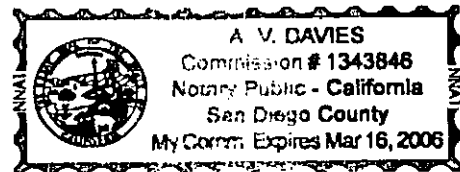

Witness my hand and official seal.

Signature *A. V. Davies*

MAIL TAX STATEMENT AS DIRECTED ABOVE

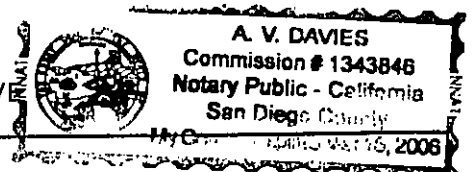

**EXHIBIT "A"**

All that certain real property situated in the County of San Diego, State of California, described as follows:

**PARCEL 1:**

That portion of the Northeast quarter of the Southeast quarter of Section 24, Township 18 South, Range 2 West, San Bernardino Meridian in the City of Chula Vista, County of San Diego, State of California, according to the Official Plat thereof described as follows:

Beginning at the Southeast corner of said Northeast quarter of the Southeast quarter, thence along the South line thereof South 89°42'04" West, 1069.30 feet to the Easterly line of freeway described in final order of condemnation recorded July 22, 1968 as File No. 123488 of Official Records; thence along said Easterly line North 3°47'10" East, 918.10 feet; thence North 80°52'26" East, 1030.62 feet to the East line of said Section; thence along said East line South 0°28'33" West, 1074.02 feet to the point of beginning.

**PARCEL 2:**

An easement for road and water pipeline purposes 15 feet wide along the existing traveled road across the Southeast quarter of the Northeast quarter and that portion of the Northeast quarter of the Southeast quarter of said section lying Northerly of the Northerly line of Parcel 1 above.

**EXCEPTING** that portion lying within said Freeway and Otay Valley Road.

Assessor's Parcel Number:       **624-071-02**

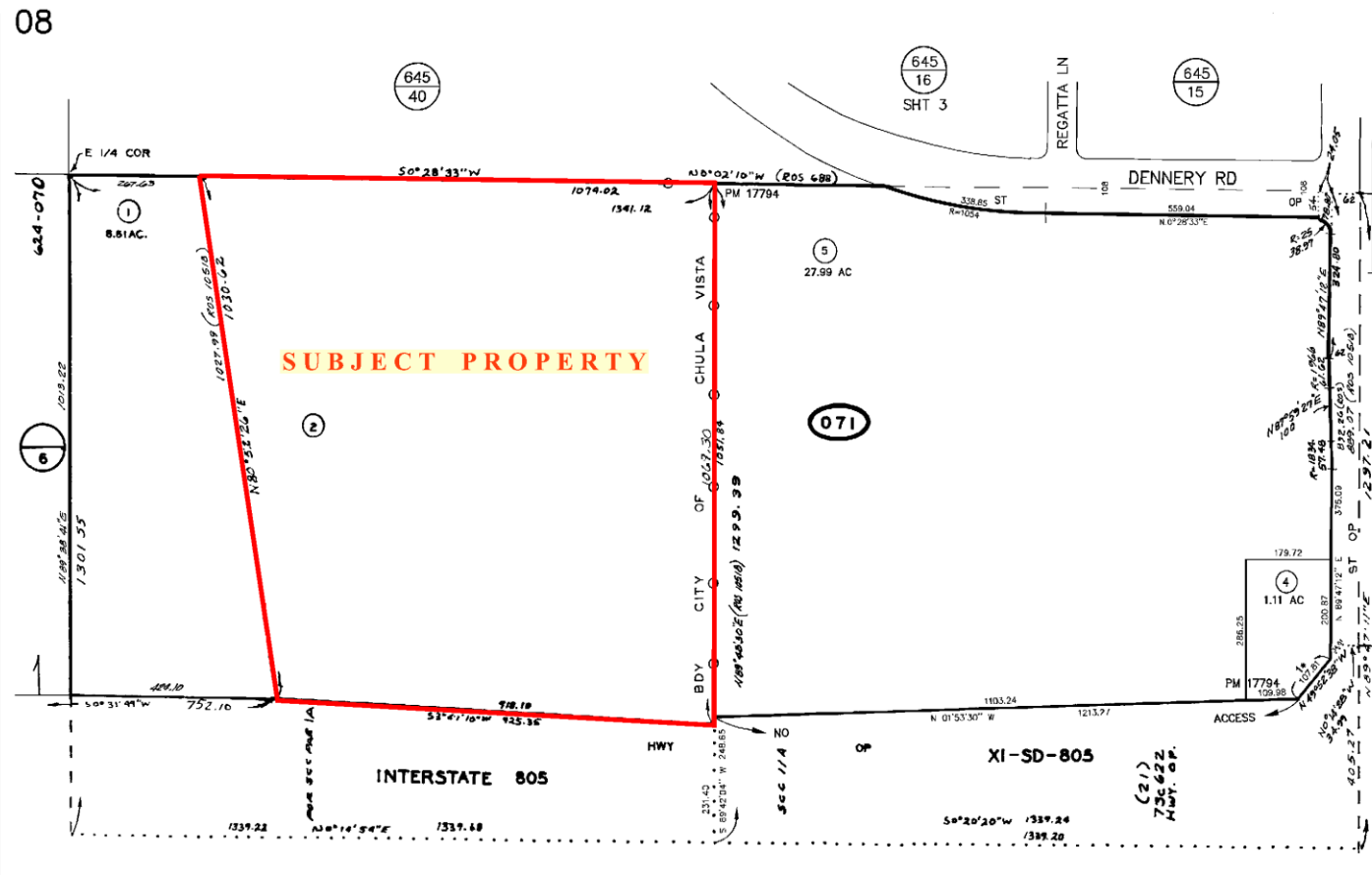

CHANGES

BLK	OLD	NEW	CUT
071	15420	1-3	10050
3	SAME ST. OP	56	4650
5	4 & 5	87	1743
5	SAME ST. OP	99	4742

Order: 00065109  
Doc: SDA 624.7

Page 2 of 2

Requested By: ehauq, Printed: 12/14/2016 9:43 AM

SAN DIEGO COUNTY  
ASSESSOR'S MAP  
BOOK 624 PAGE 07  
SHT 2 OF 2

THIS MAP WAS PREPARED FOR ASSESSMENT PURPOSES ONLY. NO LIABILITY IS ASSUMED FOR THE ACCURACY OF THE DATA SHOWN. ASSESSOR'S PARCELS MAY NOT COMPLY WITH LOCAL SUBDIVISION OR BUILDING ORDINANCES.

SEC 24 - T18S-R2W - POR SE 1/4  
ROS 681,688, 10518, 11135

**MT-1 Form 2**  
**Elevation Form**

DEPARTMENT OF HOMELAND SECURITY - FEDERAL EMERGENCY MANAGEMENT AGENCY  
**ELEVATION FORM**

O.M.B. NO. 1660-0015  
 Expires February 28, 2014

**PAPERWORK BURDEN DISCLOSURE NOTICE**

Public reporting burden for this data collection is estimated to average 1.25 hours per response. The burden estimate includes the time for reviewing instructions, searching existing data sources, gathering and maintaining the needed data, and completing and submitting the form. This collection is required to obtain or retain benefits. You are not required to respond to this collection of information unless a valid OMB control number is displayed on this form. Send comments regarding the accuracy of the burden estimate and any suggestions for reducing this burden to: Information Collections Management, Department of Homeland Security, Federal Emergency Management Agency, 1800 South Bell Street, Arlington, VA 20598-3005, Paperwork Reduction Project (1660-0015). **NOTE: Do not send your completed form to this address.**

This form must be completed for requests and must be completed and signed by a registered professional engineer or licensed land surveyor. A DHS - FEMA National Flood Insurance Program (NFIP) Elevation Certificate may be submitted in lieu of this form for single structure requests.

For requests to remove a structure on natural grade OR on engineered fill from the Special Flood Hazard Area (SFHA), submit the lowest adjacent grade (the lowest ground touching the structure), **including an attached deck or garage**. For requests to remove an entire parcel of land from the SFHA, provide the lowest lot elevation; or, if the request involves an area described by metes and bounds, provide the lowest elevation within the metes and bounds description. All measurements are to be rounded to nearest tenth of a foot. In order to process your request, all information on this form must be completed **in its entirety**. Incomplete submissions will result in processing delays.

- NFIP Community Number: 060521 Property Name or Address: Nakano (North of intersection of Dennerly Rd. & Regatta Lane, Chula Vista, CA)
- Are the elevations listed below based on  existing or  proposed conditions? (Check one)
- For the existing or proposed structures listed below, what are the types of construction? (check all that apply)  
 crawl space  slab on grade  basement/enclosure  other (explain)
- Has DHS - FEMA identified this area as subject to land subsidence or uplift? (see instructions)  Yes  No  
 If yes, what is the date of the current re-leveling? / (month/year)
- What is the elevation datum?  NGVD 29  NAVD 88  Other (explain)  
 If any of the elevations listed below were computed using a datum different than the datum used for the effective Flood Insurance Rate Map (FIRM) (e.g., NGVD 29 or NAVD 88), what was the conversion factor? 2.17  
 Local Elevation +/- ft. = FIRM Datum
- Please provide the Latitude and Longitude of the most upstream edge of the **structure** (in decimal degrees to the nearest fifth decimal place):  
 Indicate Datum:  WGS84  NAD83  NAD27 Lat. . Long. .  
 Please provide the Latitude and Longitude of the most upstream edge of the **property** (in decimal degrees to the nearest fifth decimal place):  
 Indicate Datum:  WGS84  NAD83  NAD27 Lat. 32.59048 Long. 117.03231

Address	Lot Number	Block Number	Lowest Lot Elevation*	Lowest Adjacent Grade To Structure	Base Flood Elevation	BFE Source
624-071-02-00 Chula Vista, CA		N/A	95.7		92.7	FIRM 06073C2158G (Zone AE)

This certification is to be signed and sealed by a licensed land surveyor, registered professional engineer, or architect authorized by law to certify elevation information. All documents submitted in support of this request are correct to the best of my knowledge. I understand that any false statement may be punishable by fine or imprisonment under Title 18 of the United States Code, Section 1001.

Certifier's Name: Chelisa Pack	License No.: C71026	Expiration Date: 06/30/2021
Company Name: Project Design Consultants	Telephone No.: 619.235.5471	<div style="border: 2px solid black; width: 100%; height: 100%; display: flex; align-items: center; justify-content: center;">                 Seal (optional)             </div>
Email: chelisap@projectdesign.com	Fax No.: 619.234.0349	
Signature: 	Date: 5/19/2020	

\* For requests involving a portion of property, include the lowest ground elevation within the metes and bounds description.  
 Please note: If the Lowest Adjacent Grade to Structure is the only elevation provided, a determination will be issued for the structure only.



## **APPENDIX 2**

### **Exhibits**



FIRM MSE=83.8 (NGVD29)

FIRM MSE=88.8 (NGVD29)

FIRM MSE=91.8 (NGVD29)

FIRM MSE=93.8 (NGVD29)

DAVIES PARCEL - APN 624-071-01  
 P.R. NO. 203066324 DATED 5/10/2002

OTAY RIVER

LIMITS OF FEMA 100-YEAR FLOODWAY PER FIRM 06073C2158C

LIMITS OF FEMA 100-YEAR FLOODPLAIN PER FIRM 06073C2158C

HIGHEST BFE = 92.7 (INTERPOLATED)

LOWEST ELEVATION ALONG NORTH PROPERTY LINE = 95.7

NAKANO PARCEL - APN 624-071-02  
 P.R. NO. 203066392 DATED 5/3/2002

INTERSTATE 805

DANNERY VILLAGES 2/3

LOT 'B'

DANNERY ROAD

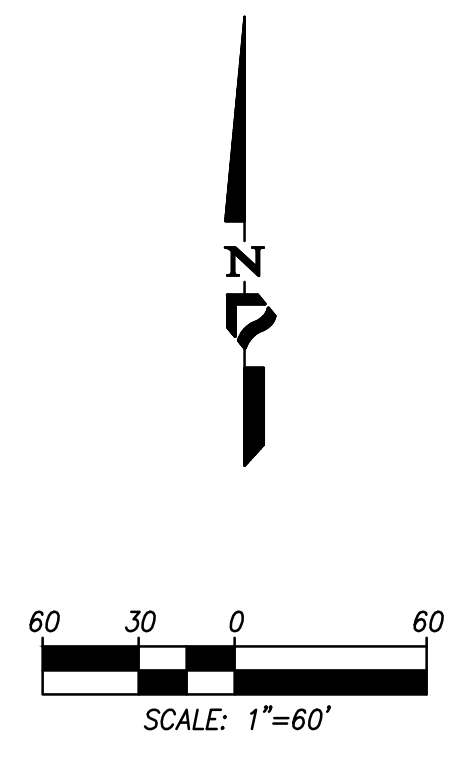

**LEGEND:**

	PROPERTY BOUNDARY
	EXISTING ZONE AE FLOODPLAIN



**TOPOGRAPHY SOURCE**  
 ONSITE TOPOGRAPHY SHOWN IS BASED UPON AN AERIAL SURVEY BY: PROJECT DESIGN CONSULTANTS, IN DECEMBER 2019. VERTICAL DATUM OF TOPOGRAPHY AS SHOWN ON THIS EXHIBIT IS NGVD29.

SCALE: 1"=60'  
 JOB #: 4409.02  
 CREATED: 4/2/20

PREPARED BY:  
  
**PROJECT DESIGN CONSULTANTS**  
 Planning | Landscape Architecture | Environmental | Engineering | Survey  
 701 B Street, Suite 800 San Diego, CA 92101  
 619.235.6471 Tel 619.234.0349 Fax

**CITY OF CHULA VISTA**  
**NAKANO**  
 EXISTING CONDITIONS FEMA FLOOD MAP  
 LETTER OF MAP AMENDMENT  
 EXHIBIT A-1

Project Name/\_\_\_\_\_

# ATTACHMENT 6

## Project's Geotechnical and Groundwater Investigation Report

Attach project's geotechnical and groundwater investigation report. Refer to Appendix C.4 to determine the reporting requirements.



Project No. 07516-42-02  
June 10, 2021

Tri Pointe Homes  
13400 Sabre Springs Parkway, Suite 200  
San Diego, California 92128

Attention: Ms. April Tornillo

Subject: UPDATE TO GEOTECHNICAL INVESTIGATION  
NAKANO PROPERTY  
CHULA VISTA, CALIFORNIA

- References:
1. *Update Geotechnical Investigation, Nakano Property, Chula Vista, California* prepared by Geocon Incorporated dated September 18, 2020 (Project No. 07516-42-02).
  2. *Grading and Storm Drain, Nakano*, prepared by Civil Sense, Inc., dated June 9, 2021.

Dear Ms. Tornillo:

In accordance with the request of Civil Sense, Inc., we have prepared this update to the referenced geotechnical investigation report for the subject project. Based on our review of Reference 2, the recommendations contained in Referenced 1 remain applicable.

Should you have questions regarding this update letter, or if we may be of further service, please contact the undersigned at your convenience.

Very truly yours,

GEOCON INCORPORATED

Rodney C. Mikesell  
GE 2533

RCM:arm

(e-mail) Addressee



**UPDATE  
GEOTECHNICAL INVESTIGATION**

---

**NAKANO PROPERTY  
CHULA VISTA, CALIFORNIA**



**GEOCON**  
INCORPORATED

GEOTECHNICAL  
ENVIRONMENTAL  
MATERIALS

PREPARED FOR  
**PARDEE HOMES**  
**SAN DIEGO, CALIFORNIA**

**SEPTEMBER 18, 2020**  
**PROJECT NO. 07516-42-02**



Project No. 07516-42-02  
September 18, 2020

Pardee Homes  
13400 Sabre Springs Parkway, Suite 200  
San Diego, California 92128

Attention: Ms. April Tornillo

Subject: UPDATE GEOTECHNICAL INVESTIGATION  
NAKANO PROPERTY  
CHULA VISTA, CALIFORNIA

Dear Ms. Tornillo:

In accordance with your authorization, we have prepared this update geotechnical investigation report for the proposed residential development at the subject site. The site is underlain by undocumented fill, colluvium, and alluvium, overlying Terrace Deposits and the Mission Valley Formation. The accompanying report presents the results of our study and conclusions and recommendations regarding geotechnical aspects of site development.

This report is based on previous and recent field observations in 2005 and 2020. It is our opinion, based on the results of this study, that the subject site is suitable for development. The accompanying report presents conclusions and recommendations regarding geotechnical aspects of development.

Should you have questions regarding this investigation, or if we may be of further service, please contact the undersigned at your convenience.

Very truly yours,

GEOCON INCORPORATED

Rodney C. Mikesell  
GE 2533

RCM:RSA:dmc

(e-mail) Addressee



Rupert S. Adams  
CEG 2561

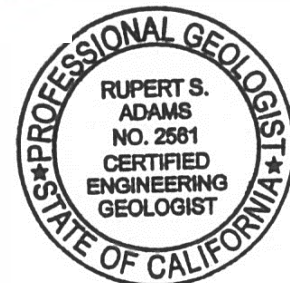

## TABLE OF CONTENTS

1.	PURPOSE AND SCOPE .....	1
2.	SITE AND PROJECT DESCRIPTION .....	1
3.	SOIL AND GEOLOGIC CONDITIONS .....	2
3.1	Undocumented Fill (Qudf) .....	2
3.2	Topsoil (Unmapped).....	3
3.3	Alluvium (Qal) .....	3
3.4	Colluvium (Qcol).....	3
3.5	Terrace Deposits (Qt) .....	3
3.6	Mission Valley Formation (Tmv).....	3
4.	GROUNDWATER .....	4
5.	GEOLOGIC HAZARDS .....	4
5.1	Faulting and Seismicity .....	4
5.2	Ground Rupture .....	6
5.3	Tsunamis and Seiches.....	6
5.4	Flooding.....	6
5.5	Liquefaction and Seismically Induced Settlement.....	7
5.6	Landslides.....	7
5.7	Geologic Hazard Category .....	7
6.	CONCLUSIONS AND RECOMMENDATIONS.....	8
6.1	General.....	8
6.2	Soil and Excavation Characteristics .....	9
6.3	Grading Recommendations .....	10
6.4	Slopes.....	12
6.5	Seismic Design Criteria (2019) .....	13
6.6	Foundations .....	15
6.7	Conventional Retaining Wall Recommendations.....	21
6.8	Lateral Loading.....	24
6.9	Preliminary Pavement Recommendations .....	25
6.10	Exterior Concrete Flatwork .....	27
6.11	Slope Maintenance.....	29
6.12	Storm Water Management.....	29
6.13	Site Drainage and Moisture Protection.....	30
6.14	Grading and Foundation Plan Review .....	30

### MAPS AND ILLUSTRATIONS

- Figure 1, Vicinity Map
- Figure 2, Geologic Map
- Figures 3 and 4, Geologic Cross-Sections
- Figure 5, Construction Detail for Lateral Extent of Removal
- Figures 6 – 9, Slope Stability Analyses

### APPENDIX A

#### FIELD INVESTIGATION

- Figure A-1, Log of Large Diameter Boring
- Figures A-2 – A-23, Logs of Exploratory Trenches

## **TABLE OF CONTENTS (Concluded)**

### APPENDIX B

#### LABORATORY TESTING

Table B-I, Summary of Laboratory Expansion Index Test Results

Table B-II, Summary of Laboratory Maximum Dry Density and Optimum Moisture Content Test Results

Table B-III, Summary of Laboratory Direct Shear Test Results

Table B-IV, Summary of Laboratory Water-Soluble Sulfate Test Results

Direct Shear Tests

### APPENDIX C

#### STORM WATER MANAGEMENT RECOMMENDATIONS

### APPENDIX D

#### RECOMMENDED GRADING SPECIFICATIONS

### LIST OF REFERENCES



# UPDATE GEOTECHNICAL INVESTIGATION

## 1. PURPOSE AND SCOPE

This report presents the results of our update geotechnical investigation for the proposed 157-lot residential development located on the Nakano Property northwest of Dennery Road, east of Interstate 805 (I-805), and south of the Otay River in Chula Vista, California (see Vicinity Map, Figure 1). The purpose of our update investigation was to further evaluate subsurface soil and geologic conditions at the site, and provide updated conclusions and recommendations pertaining to the geotechnical aspects of developing the property as proposed.

The scope of our update investigation included a site reconnaissance, excavation of one large diameter boring to a depth of 71 feet near the southwest corner of the property, performing infiltration testing in the area of the proposed BMPs, and reviewing published and unpublished geologic literature and reports (see List of References).

Appendix A presents a discussion of our field investigation. Included in Appendix A is our boring log performed for this study and trench logs performed by Geocon Incorporated on the property during previous studies. We performed laboratory tests on soil samples obtained from the large diameter boring to evaluate pertinent physical properties for engineering analyses. The results of the laboratory testing are presented in Appendix B. Also included in Appendix B is laboratory test results from our previous study.

Site geologic conditions are depicted on Figure 2 (Geologic Map). The geologic contacts were plotted on a base map provided by Civil Sense, Inc. Geologic cross sections are provided on Figures 3 and 4.

The conclusions and recommendations presented herein are based on our analysis of the data obtained during the investigation, and our experience with similar soil and geologic conditions on this and adjacent properties.

## 2. SITE AND PROJECT DESCRIPTION

The irregularly shaped, approximately 15-acre site is located northwest of the Dennery Road and Regatta Lane intersection, east of I-805 in Chula Vista, California (see Vicinity Map, Figure 1). There are no existing structures on the site, however several remnant building foundations are present. Existing utilities at the site include 18- and 27-inch diameter sewer mains along the west and northern portions of the property, respectively, high-voltage overhead electrical lines traversing the southern portion of the site, and water lines and storm drain lines in the southeast corner of the property and a reclaimed water line along the eastern property boundary. We understand the sewer main on the west

property margin and the reclaimed water line on the eastern property margin will remain. The sewer main that crosses the northern portion of the property will be removed.

Site topography is relatively flat, sloping from south to north towards the Otay River channel. A north-facing natural slope, approximately 70 feet high is present along the south property boundary. Elevations across the site range between approximately 95 and 180 feet above Mean Sea Level (MSL; see *Geologic Map*, Figure 2).

A review of proposed grading plans by Civil Sense indicates proposed improvements will consist of 157 residential lots, a park, an underground stormwater management system, utilities, and street improvements. Entrance to the property will be from a driveway at the southeast corner of the property extending from Dennery Road. The proposed development includes cuts and fills up to 15 feet in sheet graded areas and cut and fill slopes at inclinations of 2:1 (horizontal:vertical) with heights up to 55 feet.

The locations and descriptions of the site and proposed development are based on our recent site reconnaissance, previous and recent field investigations, and our understanding of site development as shown on the grading plan prepared by Civil Sense. If project details vary significantly from those described, Geocon Incorporated should be contacted to review the changes and provide additional analyses and/or revisions to this report, if warranted.

### **3. SOIL AND GEOLOGIC CONDITIONS**

Based on the results of the field investigation, the site is underlain by four surficial soil types and one formational unit, which are described below. Mapped geologic conditions are depicted on the *Geologic Map* (Figure 2, map pocket) and *Geologic Cross Sections* (Figures 3 and 4). Trench and boring logs are presented in Appendix A.

#### **3.1 Undocumented Fill (Qudf)**

We encountered undocumented fill in the trenches to depths of approximately 2 to 5 feet across the majority of the site, increasing to greater than 18 feet in the northeast portion of the site. The undocumented fill consists of very loose to moderately dense, sand with cobbles. Abundant debris including pieces of plastic, asphalt concrete, concrete curb, brick and wood were also encountered in the undocumented fill. The undocumented fill is compressible in its current state and will require complete removal and recompaction to support compacted fill and/or proposed site improvements.

### **3.2 Topsoil (Unmapped)**

Topsoil covers the majority of the site and varies in thickness from 0.5 feet to 3 feet. The topsoil typically consists of loose to moderately dense, dry to moist, sand, cobble and clay. The topsoil is compressible and will require removal and recompaction to support compacted fill and/or proposed site improvements.

### **3.3 Alluvium (Qal)**

Alluvium is present in a drainage located at the southeast corner of the property. Alluvium was also encountered in Trench T-20 beneath undocumented fill at the north end of the site. The alluvium consists of stiff, damp, dark brown, sandy clay with gravel. The alluvium is compressible and will require removal and recompaction to support compacted fill and/or proposed site improvements.

### **3.4 Colluvium (Qcol)**

Colluvium is derived from weathering of the underlying bedrock materials at higher elevations and is deposited by gravity and sheet-flow on the side slopes and canyon sidewalls. The observed thickness of colluvium at the site was approximately 3 to 5 feet near trench T-6. The colluvium as encountered consists of moderately dense, olive brown, clayey sand with cobbles. The colluvium is compressible in its current state and will require removal and recompaction to support compacted fill and/or proposed site improvements.

### **3.5 Terrace Deposits (Qt)**

Quaternary-age Terrace Deposits were observed underlying artificial fill, topsoil, and alluvium in the flatter portions of the site. The Terrace Deposits consist of moderately dense to very dense and firm to very stiff, clayey gravel, clayey to cobbly sand, and silty to cobbly clay. Terrace Deposits are suitable for support of compacted fill and/or structural loads.

### **3.6 Mission Valley Formation (Tmv)**

Upper Eocene-age Mission Valley Formation was encountered in slopes along the southern portion of the site. The Mission Valley Formation is predominantly a marine sandstone unit consisting of reddish brown to tan, weak to friable, silty, fine- to medium-grained sandstone. The formation is typically moderately to well cemented but is usually rippable with heavy duty excavation equipment; however, localized cemented zones and concretions should be expected. The Mission Valley Formation is suitable for the support of the compacted fill and structural loads.

## 4. GROUNDWATER

We did not encounter groundwater or seepage during our recent or previous site investigations. However, it is not uncommon for shallow seepage conditions to develop where none previously existed when sites are irrigated or infiltration is implemented. Seepage is dependent on seasonal precipitation, irrigation, land use, among other factors, and varies as a result. Proper surface drainage will be important to future performance of the project. We expect the groundwater elevation at the site to be between 80 and 90 feet MSL. We do not anticipate encountering groundwater during construction of the proposed development.

## 5. GEOLOGIC HAZARDS

### 5.1 Faulting and Seismicity

A review of the referenced geologic materials and our knowledge of the general area indicates that the site is not underlain by active, potentially active, or inactive faults. An active fault is defined by the California Geological Survey (CGS) as a fault showing evidence for activity within the last 11,700 years. The site is not located within a State of California Earthquake Fault Zone.

The United States Geological Survey (USGS) has developed a program to evaluate the approximate location of faulting. The following figure shows the location of the existing faulting in the San Diego County and Southern California region. The faults are shown as solid, dashed and dotted traces representing well-constrained, moderately constrained and inferred faults, respectively. The fault line colors represent faults with ages less than 150 years (red), 15,000 years (orange), 130,000 years (green), 750,000 years (blue) and 1.6 million years (black).

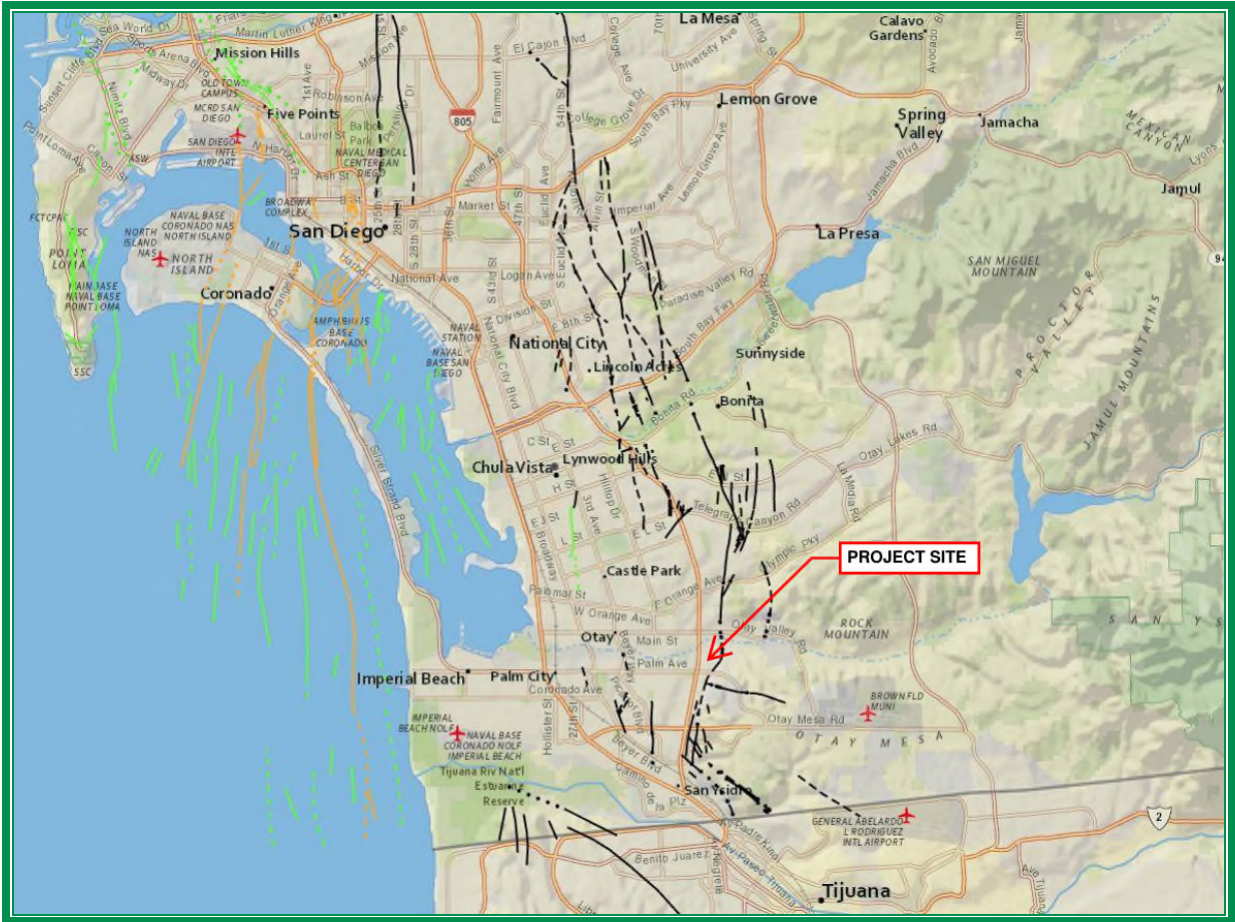

Faults in the San Diego Area

The San Diego County and Southern California region is seismically active. The following figure presents the occurrence of earthquakes with a magnitude greater than 2.5 from the period of 1900 through 2015 according to the Bay Area Earthquake Alliance website.

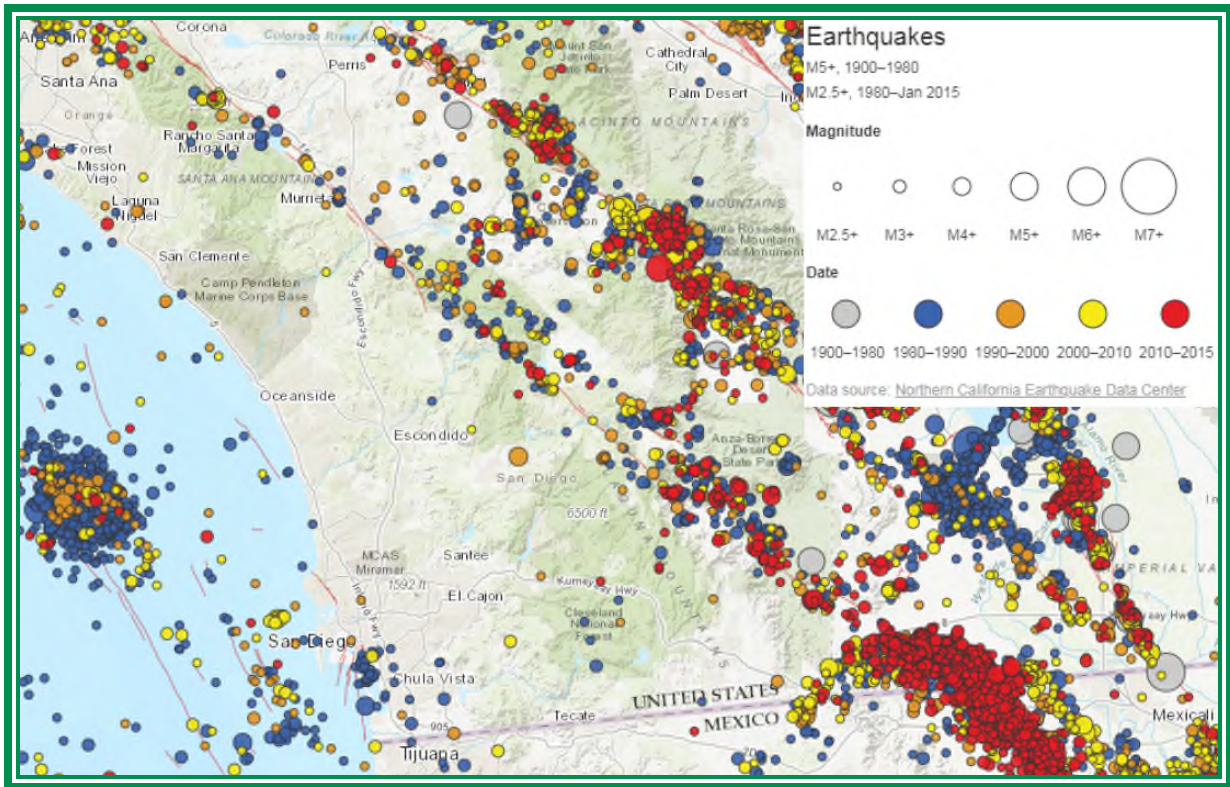

**Earthquakes in Southern California**

Considerations important in seismic design include the frequency and duration of motion and the soil conditions underlying the site. Seismic design of structures should be evaluated in accordance with the California Building Code (CBC) guidelines currently adopted by the local agency.

## 5.2 Ground Rupture

The risk associated with ground rupture hazard is very low due to the absence of active faults at the subject site.

## 5.3 Tsunamis and Seiches

The site is not located near the ocean or downstream of any large bodies of standing water. Therefore, the risk of tsunamis or seiches associated with the site is low.

## 5.4 Flooding

According to maps produced by the Federal Emergency Management Agency (FEMA), the majority of the site is zoned as “Zone X – Minimal Flood Hazard.” However, the limits of the 100- and 500-year flood zones are on or immediately adjacent to the north property boundary. Based on our review of FEMA flood maps, the risk of site flooding from channel overflow of the Otay River is low.

## **5.5 Liquefaction and Seismically Induced Settlement**

Soil liquefaction occurs within relatively loose, cohesionless sand located below the water table that is subjected to ground accelerations from earthquakes. Due to the dense nature of the soils underlying the site, proposed grading, and the lack of permanent, shallow groundwater, there is a low risk of liquefaction occurring at the site.

## **5.6 Landslides**

Based on our review of published geologic maps for the site vicinity, landslides are not mapped on the property or at a location that could impact the site. Based on our review of historical aerial photographs, landslide-related features are not discernable in the north-facing slope located near the south property boundary. However, landslides have been mapped east of the site in the Otay Formation, which overlies the Mission Valley Formation on the upthrown side of the La Nacion Fault zone.

Bedding attitudes recorded during downhole logging of boring LD-1 are similar to those recorded in areas surrounding the site. Steeper westerly dips ranging between 10 and 20 degrees were observed in the boring, compared to three to five degrees west shown on local geologic maps. Steeper dips are attributed to localized deformation resulting from movement on the La Nacion fault zone. The proposed cut slope shown on the site plan is oriented perpendicular to strike, therefore no significant out-of-slope dip component is anticipated. However, given the proximity of other landslides, we recommend cut slope mapping during grading.

## **5.7 Geologic Hazard Category**

Review of the 2008 City of San Diego Seismic Safety Study, Geologic Hazards and Faults, Sheet 6, indicates the site is mapped as Geologic Hazard Categories 22 and 52. Category 22 is described as-Landslides – possible or conjectured. Category 52 is described as-Other Terrain, other level areas, gently sloping to steep terrain, favorable geologic structure, low risk.

## 6. CONCLUSIONS AND RECOMMENDATIONS

### 6.1 General

- 6.1.1 No soil or geologic conditions were observed that would preclude the development of the property as presently proposed provided that the recommendations of this report are followed.
- 6.1.2 The site is underlain by compressible surficial deposits consisting of undocumented fill, topsoil, colluvium, alluvium that generally range from 2 to 9 feet thick, but exceeds 18 feet thick in the northwest portion of the site. The surficial soils will require complete removal and recompaction.
- 6.1.3 Terrace deposits underlie the surficial deposits in the flatter areas of the site. The Tertiary-aged Mission Valley Formation is exposed in the north facing slope adjacent to the south property boundary. Terrace Deposits and the Mission Valley Formation are suitable for support of the planned project.
- 6.1.4 With the exception of possible strong seismic shaking, no significant geologic hazards were observed or are known to exist on the site that would adversely affect the site. No special seismic design considerations, other than those recommended herein, are required.
- 6.1.5 Groundwater was not encountered during our investigation. However, groundwater may be encountered during remedial grading on the north side of the property adjacent to the Otay River channel.
- 6.1.6 Based on our experience and prior laboratory testing, we expect the majority of on-site soils to possess a very low to medium expansion potential. We also expect the soils to have negligible sulfate exposure to concrete structures.
- 6.1.7 Cut slopes should be observed and mapped during grading by an engineering geologist to verify that the soil and geologic conditions do not differ significantly from those anticipated.
- 6.1.8 Provided the recommendations of this report are followed, it is our opinion that the proposed development will not destabilize or result in settlement of adjacent properties and City right-of-way.



## 6.2 Soil and Excavation Characteristics

- 6.2.1 In general, special shoring requirements may not be necessary if temporary excavations will be less than 4 feet in height. It is the responsibility of the contractor and their competent person to ensure all excavations, temporary slopes and trenches are properly constructed and maintained in accordance with applicable OSHA guidelines, in order to maintain safety and the stability of the excavations and adjacent improvements. These excavations should not be allowed to become saturated or to dry out. Surcharge loads should not be permitted to a distance equal to the height of the excavation from the top of the excavation. The top of the excavation should be a minimum of 15 feet from the edge of existing improvements. Excavations steeper than those recommended or closer than 15 feet from an existing surface improvement should be shored in accordance with applicable OSHA codes and regulations.
- 6.2.2 Excavation of existing undocumented fill and surficial deposits should be possible with moderate to heavy effort using conventional heavy-duty equipment. Excavation of the Mission Valley Formation may require very heavy effort with conventional heavy-duty grading equipment.
- 6.2.3 The soil encountered during our field investigations is considered to be both “non-expansive” (expansion index [EI] of 20 or less) and “expansive” (EI greater than 20) as defined by 2019 California Building Code (CBC) Section 1803.5.3. Table 6.2.1 presents soil classifications based on the expansion index. Based on prior laboratory test results, the majority of the soil encountered is expected to possess a “very low” to “medium” expansion potential. Samples of near pad grade soils should be collected after the completion of grading to evaluate expansion index.

**TABLE 6.2.1  
EXPANSION CLASSIFICATION BASED ON EXPANSION INDEX**

Expansion Index (EI)	Expansion Classification	2019 CBC Expansion Classification
0 – 20	Very Low	Non-Expansive
21 – 50	Low	Expansive
51 – 90	Medium	
91 – 130	High	
Greater Than 130	Very High	

- 6.2.4 Results from prior laboratory testing indicate the on-site soils possess an “S0” sulfate exposure class to concrete structures as defined by 2019 CBC Section 1904 and ACI 318-08 Sections 4.2 and 4.3. Table 6.2.2 presents a summary of concrete requirements set forth by

2019 CBC Section 1904 and ACI 318. The presence of water-soluble sulfates is not a visually discernible characteristic; therefore, other soil samples from the site could yield different concentrations. Additionally, over time landscaping activities (i.e., addition of fertilizers and other soil nutrients) may affect the concentration. Samples of near pad grade soils should be collected to evaluate water-soluble sulfates after the completion of grading.

**TABLE 6.2.2  
REQUIREMENTS FOR CONCRETE EXPOSED TO  
SULFATE-CONTAINING SOLUTIONS**

Exposure Class	Water-Soluble Sulfate Percent by Weight	Cement Type	Maximum Water to Cement Ratio by Weight	Minimum Compressive Strength (psi)
S0	0.00-0.10	--	--	2,500
S1	0.10-0.20	II	0.50	4,000
S2	0.20-2.00	V	0.45	4,500
S3	> 2.00	V+Pozzolan or Slag	0.45	4,500

6.2.5 Geocon Incorporated does not practice in the field of corrosion engineering; therefore, further evaluation by a corrosion engineer may be needed to incorporate the necessary precautions to avoid premature corrosion of underground pipes and buried metal in direct contact with soil.

### 6.3 Grading Recommendations

6.3.1 All grading should be performed in accordance with the *Recommended Grading Specifications* contained in Appendix D. Where the recommendations of this section conflict with those of Appendix D, **the recommendations of this section take precedence**. All earthwork should be observed and all fill tested for proper compaction by Geocon Incorporated.

6.3.2 Prior to commencing grading, a preconstruction conference should be held at the site with the owner or developer, grading contractor, civil engineer, City of Chula Vista representatives, and geotechnical engineer in attendance. Special soil handling and/or the grading plans can be discussed at that time.

6.3.3 Site preparation should begin with the removal of deleterious material, debris, and vegetation. The depth of vegetation removal should be such that material exposed in cut areas or soil to be used as fill is relatively free of organic matter. Material generated during

stripping and/or site demolition should be exported from the site. Asphalt and concrete should not be mixed with the fill soil unless approved by the Geotechnical Engineer.

- 6.3.4 Abandoned foundations and buried utilities (if encountered) should be removed and the resultant depressions and/or trenches backfilled with properly compacted soil as part of the remedial grading.
- 6.3.5 All compressible soil deposits including undocumented fill, stockpiles, alluvium and colluvium within areas where structural improvements and/or structural fills are planned, should be removed to expose the underlying Terrace Deposits or Mission Valley Formation, prior to placing additional fill and/or structural loads. The actual extent of unsuitable soil removals will be evaluated in the field during grading by the geotechnical engineer and/or engineering geologist.
- 6.3.6 Based on the current grading plan, cut to fill transitions are expected within some of the lots. Lots with cut-fill transitions should be undercut at least 3 feet and replaced with properly compacted fill. The undercut should be sloped at a minimum of 1 percent toward the street or deeper fill area.
- 6.3.7 Removal of compressible surficial soils should extend beyond the toe of fill slopes a horizontal distance equal to the depth of the remedial removal (see Figure 5 for general information). The actual extent of remedial grading should be determined in the field by the geotechnical engineer or engineering geologist.
- 6.3.8 Prior to placing fill, the base of excavations and surface of previously placed fill and compacted fill should be scarified; moisture conditioned as necessary and compacted. Fill soils may then be placed and compacted in layers to the design finish grade elevations. In general, on-site soils are suitable for re-use as fill if free from vegetation, debris and other deleterious material. Layers of fill should be no thicker than will allow for adequate bonding and compaction. All fill, including scarified ground surfaces and backfill, should be compacted to at least 90 percent of laboratory maximum dry density as determined by ASTM D 1557 at or slightly above optimum moisture content. Overly wet materials will require drying and/or mixing with drier soils to facilitate proper compaction.
- 6.3.9 The upper 3 feet of fill on all lots and streets should be composed of properly compacted *very low* to *low* expansive soils. Highly expansive soils, if encountered, should be placed in deeper fill areas and properly compacted. *Very low* to *low* expansive soils are defined as those soils that have an Expansion Index of 50 or less. Boulders, concretions, concrete chunks greater than 12 inches in maximum dimension should not be placed within 5 feet of

finish grade or 3 feet from the deepest utility within streets. Specific recommendations for the placement of oversize rock is contained in the *Grading Specifications* contained in Appendix D.

- 6.3.10 Imported fill (if necessary) should consist of granular materials with a *very low* to *low* expansion potential (EI of 50 or less), be free of deleterious material or stones larger than 3 inches, and should be compacted as recommended herein. Geocon Incorporated should be notified of the import soil source and should be authorized to perform laboratory testing of import soil prior to its arrival at the site to evaluate its suitability as fill material.

## **6.4 Slopes**

- 6.4.1 Slope stability analyses were performed for proposed cut slopes up to 55 feet high (2:1 gradient), the existing hillside slope (2.5:1 or flatter) that has a height up to approximately 120 feet and extends onto the property to the south, and proposed fill slopes up to 10 feet in height (2:1 gradient). The stability analyses were performed using simplified Janbu analysis. Our analyses utilized average drained direct shear strength parameters based on laboratory tests performed for this project and our experience with similar soils. The analyses indicate planned cut and fill slopes, and the existing native perimeter slope will have a calculated factors of safety in excess of 1.5 under static conditions for both deep-seated failure and shallow sloughing conditions. A summary of slope stability analyses is presented on Figures 6 through 9.
- 6.4.2 All cut slope excavations should be observed during grading by an engineering geologist to verify that soil and geologic conditions do not differ significantly from those anticipated.
- 6.4.3 The outer 15 feet (or a distance equal to the height of the slope, whichever is less) of fill slopes should be composed of properly compacted granular *soil* fill to reduce the potential for surficial sloughing. Granular “soil” fill is defined as a well-graded soil mix with less than 20 percent fines (silt and clay particles). Poorly graded soils with less than 5 percent fines should not be used in the slope zone due to high erosion potential. All slopes should be compacted by backrolling with a loaded sheepsfoot roller at vertical intervals not to exceed 4 feet and should be track-walked at the completion of each slope such that the fill soils are uniformly compacted to at least 90 percent relative compaction to the face of the finished sloped.
- 6.4.4 All slopes should be landscaped with drought-tolerant vegetation, having variable root depths and requiring minimal landscape irrigation. In addition, all slopes should be drained and properly maintained to reduce erosion.

## 6.5 Seismic Design Criteria (2019)

6.5.1 Table 6.5.1 summarizes site-specific design criteria obtained from the 2019 California Building Code (CBC; Based on the 2018 International Building Code [IBC] and ASCE 7-16), Chapter 16 Structural Design, Section 1613 Earthquake Loads. We used the computer program *U.S. Seismic Design Maps*, provided by the Structural Engineers Association of California (SEAOC) to calculate the seismic design parameters. The short spectral response uses a period of 0.2 second. We evaluated the Site Class based on the discussion in Section 1613.2.2 of the 2019 CBC and Table 20.3-1 of ASCE 7-16. Site Class C can be used for lots with fill thickness of 20 feet or less. Site Class D is applicable to lots with fill thicknesses greater than 20 feet. The majority of the site falls within Site Class C. A couple lots in the northwest corner might fall into Site Class D after completion of remedial grading. The values presented herein are for the risk-targeted maximum considered earthquake ( $MCE_R$ ). Sites designated as Site Class D, E and F may require additional analyses if requested by the project structural engineer and client.

**TABLE 6.5.1  
2019 CBC SEISMIC DESIGN PARAMETERS**

Parameter	Value		2019 CBC Reference
	C	D	
Site Class	C	D	Section 1613.2.2
$MCE_R$ Ground Motion Spectral Response Acceleration – Class B (short), $S_S$	0.901g	0.901g	Figure 1613.2.1(1)
$MCE_R$ Ground Motion Spectral Response Acceleration – Class B (1 sec), $S_1$	0.315g	0.315g	Figure 1613.2.1(2)
Site Coefficient, $F_A$	1.2	1.14	Table 1613.2.3(1)
Site Coefficient, $F_V$	1.5	1.985*	Table 1613.2.3(2)
Site Class Modified $MCE_R$ Spectral Response Acceleration (short), $S_{MS}$	1.081g	1.027g	Section 1613.2.3 (Eqn 16-36)
Site Class Modified $MCE_R$ Spectral Response Acceleration – (1 sec), $S_{M1}$	0.472g	0.625g*	Section 1613.2.3 (Eqn 16-37)
5% Damped Design Spectral Response Acceleration (short), $S_{DS}$	0.721g	0.684g	Section 1613.2.4 (Eqn 16-38)
5% Damped Design Spectral Response Acceleration (1 sec), $S_{D1}$	0.315g	0.417g*	Section 1613.2.4 (Eqn 16-39)

\* Using the code-based values presented in this table, in lieu of a performing a ground motion hazard analysis, requires the exceptions outlined in ASCE 7-16 Section 11.4.8 be followed by the project structural engineer. Per Section 11.4.8 of ASCE/SEI 7-16, a ground motion hazard analysis should be performed for projects for Site Class “E” sites with  $S_s$  greater than or equal to 1.0g and for Site Class “D” and “E” sites with  $S_1$  greater than 0.2g. Section 11.4.8 also provides exceptions which indicates that the ground motion hazard analysis may be waived provided the exceptions are followed.

6.5.2 Table 6.5.2 presents the mapped maximum considered geometric mean ( $MCE_G$ ) seismic design parameters for projects located in Seismic Design Categories of D through F in accordance with ASCE 7-16.

**TABLE 6.5.2  
ASCE 7-16 PEAK GROUND ACCELERATION**

Parameter	Value		ASCE 7-16 Reference
Site Class	C	D	
Mapped $MCE_G$ Peak Ground Acceleration, $PGA$	0.396	0.396	Figure 22-7
Site Coefficient, $F_{PGA}$	1.2	1.204	Table 11.8-1
Site Class Modified $MCE_G$ Peak Ground Acceleration, $PGA_M$	0.475	0.477g	Section 11.8.3 (Eqn 11.8-1)

6.5.3 Conformance to the criteria in Tables 6.5.1 and 6.5.2 for seismic design does not constitute any kind of guarantee or assurance that significant structural damage or ground failure will not occur if a large earthquake occurs. The primary goal of seismic design is to protect life, not to avoid all damage, since such design may be economically prohibitive.

6.5.4 The project structural engineer and architect should evaluate the appropriate Risk Category and Seismic Design Category for the planned structures. The values presented herein assume a Risk Category of II and resulting in a Seismic Design Category D. Table 6.5.3 presents a summary of the risk categories.

**TABLE 6.5.3  
ASCE 7-16 RISK CATEGORIES**

Risk Category	Building Use	Examples
I	Low risk to Human Life at Failure	Barn, Storage Shelter
II	Nominal Risk to Human Life at Failure (Buildings Not Designated as I, III or IV)	Residential, Commercial and Industrial Buildings
III	Substantial Risk to Human Life at Failure	Theaters, Lecture Halls, Dining Halls, Schools, Prisons, Small Healthcare Facilities, Infrastructure Plants, Storage for Explosives/Toxins
IV	Essential Facilities	Hazardous Material Facilities, Hospitals, Fire and Rescue, Emergency Shelters, Police Stations, Power Stations, Aviation Control Facilities, National Defense, Water Storage

## 6.6 Foundations

6.6.1 The following foundation recommendations apply to one- to three story structures and are based on the building pads being underlain by properly compacted fill or native soils, and soil within 3 feet of finish grade consisting of *very low* to *medium* expansive soils (Expansion Index of 90 or less). The foundation recommendations have been separated into three categories dependent on the thickness and geometry of the underlying fill soils as well as the expansion index of the prevailing subgrade soils of a particular building pad (or lot). The foundation category criteria are presented in Table 6.6.1

**TABLE 6.6.1  
FOUNDATION CATEGORY CRITERIA**

Foundation Category	Maximum Fill Thickness, T (feet)	Differential Fill Thickness, D (feet)	Expansion Index (EI)
I	$T < 20$	--	$EI \leq 50$
II	$20 \leq T < 50$	$10 \leq D < 20$	$50 < EI \leq 90$
III	$T \geq 50$	$D \geq 20$	$90 < EI \leq 130$

6.6.2 We will provide final foundation categories for each building or lot after completion of grading (finish pad grades have been achieved) and laboratory expansion testing of the finish grade soils is complete.

6.6.3 The proposed structures can be supported on a shallow foundation system founded in the compacted fill/formational materials. Foundations for the structure should consist of continuous strip footings and/or isolated spread footings. Table 6.6.2 presents minimum foundation and interior concrete slab design criteria for conventional foundation systems.

**TABLE 6.6.2  
CONVENTIONAL FOUNDATION RECOMMENDATIONS BY CATEGORY**

Foundation Category	Minimum Footing Embedment Depth (inches)	Continuous Footing Reinforcement	Interior Slab Reinforcement
I	12	Two No. 4 bars, one top and one bottom	6 x 6 - 10/10 welded wire mesh at slab mid-point
II	18	Four No. 4 bars, two top and two bottom	No. 3 bars at 24 inches on center, both directions
III	24	Four No. 5 bars, two top and two bottom	No. 3 bars at 18 inches on center, both directions

6.6.4 Table 6.6.3 provides a summary of the foundation design recommendations.

**TABLE 6.6.3  
SUMMARY OF FOUNDATION RECOMMENDATIONS**

Parameter	Value
Minimum Continuous Foundation Width	12 inches
Minimum Isolated Foundation Width	24 inches
Minimum Foundation Depth	See Table 6.6.2
Minimum Steel Reinforcement	See Table 6.6.2
Allowable Bearing Capacity	2,000 psf
Bearing Capacity Increase	500 psf per additional foot of footing depth
	300 psf per additional foot of footing width
Maximum Allowable Bearing Capacity	4,000 psf
Estimated Total Settlement	1 Inch
Estimated Differential Settlement	½ Inch in 40 Feet
Footing Size Used for Settlement	9-Foot Square
Design Expansion Index	50 or less

6.6.5 The foundations should be embedded in accordance with the recommendations herein and the Wall/Column Footing Dimension Detail below. The embedment depths should be measured from the lowest adjacent pad grade for both interior and exterior footings. Footings should be deepened such that the bottom outside edge of the footing is at least 7 feet horizontally from the face of the slope (unless designed with a post-tensioned foundation system as discussed herein).

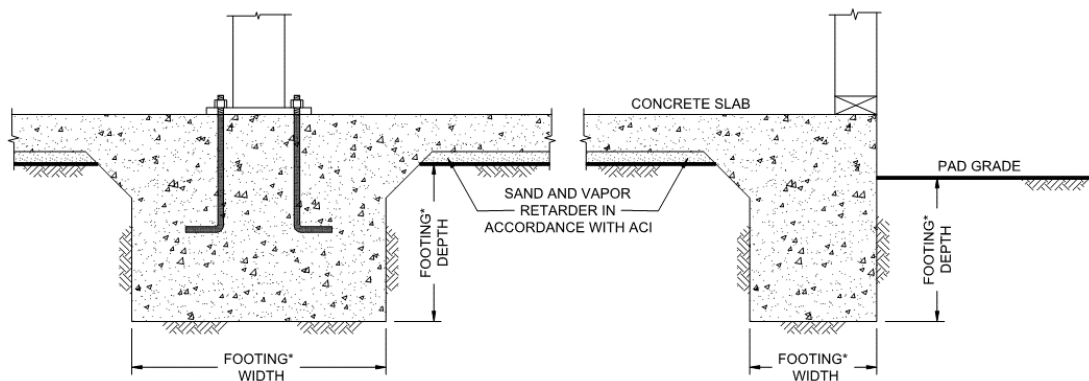

**Wall/Column Footing Dimension Detail**

6.6.6 The bearing capacity values presented herein are for dead plus live loads and may be increased by one-third when considering transient loads due to wind or seismic forces.



- 6.6.7 Under the recommended allowable bearing pressures provided, we expect settlement as a result of building loading to be less than 1-inch total and ½-inch differential over a span of 40 feet.
- 6.6.8 Conventional building concrete slabs-on-grade should be at least 4 inches thick for Foundation Categories I and II and 5 inches thick for Foundation Category III.
- 6.6.9 A vapor retarder should underlie slabs that may receive moisture-sensitive floor coverings or may be used to store moisture-sensitive materials. The vapor retarder design should be consistent with the guidelines presented in the American Concrete Institute's (ACI) *Guide for Concrete Slabs that Receive Moisture-Sensitive Flooring Materials* (ACI 302.2R-06). In addition, the membrane should be installed in accordance with manufacturer's recommendations and ASTM requirements and in a manner that prevents puncture. The project architect or developer should specify the type of vapor retarder used based on the type of floor covering that will be installed and if the structure will possess a humidity controlled environment.
- 6.6.10 The project foundation engineer, architect, and/or developer should determine the thickness of bedding sand below the slab. However, Geocon should be contacted to provide recommendations if the bedding sand is thicker than 6 inches.
- 6.6.11 The foundation design engineer should provide appropriate concrete mix design criteria and curing measures to assure proper curing of the slab by reducing the potential for rapid moisture loss and subsequent cracking and/or slab curl. We suggest that the foundation design engineer present the concrete mix design and proper curing methods on the foundation plans. It is critical that the foundation contractor understands and follows the specifications presented on the foundation plans.
- 6.6.12 As an alternative to the conventional foundation recommendations, consideration should be given to the use of post-tensioned concrete slab and foundation systems for the support of the proposed structures. The post-tensioned systems should be designed by a structural engineer experienced in post-tensioned slab design and design criteria of the Post-Tensioning Institute (PTI) DC10.5 *Standard Requirements for Design and Analysis of Shallow Post-Tensioned Concrete Foundations on Expansive Soils* or *WRI/CRSI Design of Slab-on-Ground Foundations*, as required by the 2019 California Building Code (CBC Section 1808.6.2). Although this procedure was developed for expansive soil conditions, we understand it can also be used to reduce the potential for foundation distress due to differential fill settlement. The post-tensioned design should incorporate the geotechnical

parameters presented on Table 6.6.4. The parameters presented in Table 6.6.4 are based on the guidelines presented in the PTI, DC10.5 design manual.

**TABLE 6.6.4  
POST-TENSIONED FOUNDATION SYSTEM DESIGN PARAMETERS**

Post-Tensioning Institute (PTI), Third Edition Design Parameters	Foundation Category		
	I	II	III
Thornthwaite Index	-20	-20	-20
Equilibrium Suction	3.9	3.9	3.9
Edge Lift Moisture Variation Distance, $e_M$ (feet)	5.3	5.1	4.9
Edge Lift, $y_M$ (inches)	0.61	1.10	1.58
Center Lift Moisture Variation Distance, $e_M$ (feet)	9.0	9.0	9.0
Center Lift, $y_M$ (inches)	0.30	0.47	0.66

6.6.13 The foundations for the post-tensioned slabs should be embedded in accordance with the recommendations of the structural engineer. For moisture cut-off, we recommend the perimeter foundation have an embedment depth of at least 12 inches. If a post-tensioned mat foundation system is planned, the slab should possess a thickened edge with a minimum width of 12 inches that extends at least 12 inches below the clean sand layer.

6.6.14 If the structural engineer proposes a post-tensioned foundation design method other than PTI, DC 10.5:

- The deflection criteria presented in Table 6.6.4 are still applicable.
- Interior stiffener beams should be used for Foundation Categories II and III.
- The width of the perimeter foundations should be at least 12 inches.
- The perimeter footing embedment depths should be at least 12 inches, 18 inches and 24 inches for foundation categories I, II, and III, respectively. The embedment depths should be measured from the lowest adjacent pad grade.

6.6.15 Foundation systems for the lots that possess a foundation Category I and a “very low” expansion potential (expansion index of 20 or less) can be designed using the method described in Section 1808 of the 2019 CBC. If post-tensioned foundations are planned, an alternative, commonly accepted design method (other than PTI) can be used. However, the post-tensioned foundation system should be designed with a total and differential deflection of 1 inch. Geocon Incorporated should be contacted to review the plans and provide additional information, if necessary.

- 6.6.16 If an alternate design method is contemplated, Geocon Incorporated should be contacted to evaluate if additional expansion index testing should be performed to identify the lots that possess a “very low” expansion potential (expansion index of 20 or less).
- 6.6.17 Our experience indicates post-tensioned slabs are susceptible to excessive edge lift, regardless of the underlying soil conditions. Placing reinforcing steel at the bottom of the perimeter footings and the interior stiffener beams may mitigate this potential. Current PTI design procedures primarily address the potential center lift of slabs but, because of the placement of the reinforcing tendons in the top of the slab, the resulting eccentricity after tensioning reduces the ability of the system to mitigate edge lift. The structural engineer should design the foundation system to reduce the potential of edge lift occurring for the proposed structures.
- 6.6.18 During the construction of the post-tension foundation system, the concrete should be placed monolithically. Under no circumstances should cold joints form between the footings/grade beams and the slab during the construction of the post-tension foundation system unless designed by the project structural engineer.
- 6.6.19 Isolated footings outside of the slab area, if present, should have the minimum embedment depth and width recommended for conventional foundations for a particular Foundation Category. The use of isolated footings, which are located beyond the perimeter of the building and support structural elements connected to the building, are not recommended for Category III. Where this condition cannot be avoided, the isolated footings should be connected to the building foundation system with grade beams. In addition, consideration should be given to connecting patio slabs, which exceed 5 feet in width, to the building foundation to reduce the potential for future separation to occur.
- 6.6.20 Interior stiffening beams should be incorporated into the design of the foundation system in accordance with the PTI design procedures.
- 6.6.21 Special subgrade presaturation is not deemed necessary prior to placing concrete; however, the exposed foundation and slab subgrade soil should be moisture conditioned, as necessary, to maintain a moist condition as would be expected in any such concrete placement.
- 6.6.22 Where buildings or other improvements are planned near the top of a slope steeper than 3:1 (horizontal:vertical), special foundations and/or design considerations are recommended due to the tendency for lateral soil movement to occur.

- For fill slopes less than 20 feet high or cut slopes regardless of height, footings should be deepened such that the bottom outside edge of the footing is at least 7 feet horizontally from the face of the slope.
- For fill slopes greater than 20 feet high, foundations should be extended to a depth where the minimum horizontal distance is equal to  $H/3$  (where H equals the vertical distance from the top of the fill slope to the base of the fill soil) with a minimum of 7 feet but need not exceed 40 feet. The horizontal distance is measured from the outer, deepest edge of the footing to the face of the slope. A post-tensioned slab and foundation system or mat foundation system can be used to help reduce potential foundation distress associated with slope creep and lateral fill extension. Specific design parameters or recommendations for either of these alternatives can be provided once the building location and fill slope geometry have been determined.
- If swimming pools are planned, Geocon Incorporated should be contacted for a review of specific site conditions.
- Swimming pools located within 7 feet of the top of cut or fill slopes are not recommended. Where such a condition cannot be avoided, the portion of the swimming pool wall within 7 feet of the slope face be designed assuming that the adjacent soil provides no lateral support. This recommendation applies to fill slopes up to 30 feet in height, and cut slopes regardless of height. For swimming pools located near the top of fill slopes greater than 30 feet in height, additional recommendations may be required and Geocon Incorporated should be contacted for a review of specific site conditions.
- Although other improvements that are relatively rigid or brittle, such as concrete flatwork or masonry walls, may experience some distress if located near the top of a slope, it is generally not economical to mitigate this potential. It may be possible, however, to incorporate design measures that would permit some lateral soil movement without causing extensive distress. Geocon Incorporated should be consulted for specific recommendations.

6.6.23 The recommendations of this report are intended to reduce the potential for cracking of slabs due to expansive soil (if present), differential settlement of existing soil or soil with varying thicknesses. However, even with the incorporation of the recommendations presented herein, foundations, stucco walls, and slabs-on-grade placed on such conditions may still exhibit some cracking due to soil movement and/or shrinkage. The occurrence of concrete shrinkage cracks is independent of the supporting soil characteristics. The occurrence may be reduced and/or controlled by: limiting the slump of the concrete, proper concrete placement and curing, and by the placement of crack control joints at periodic intervals, in particular, where re-entrant slab corners occur.

6.6.24 Geocon Incorporated should be consulted to provide additional design parameters as required by the structural engineer.

## 6.7 Conventional Retaining Wall Recommendations

6.7.1 Retaining walls should be designed using the values presented in Table 6.7.1. Soil with an expansion index (EI) of greater than 50 should not be used as backfill material behind retaining walls.

**TABLE 6.7.1  
RETAINING WALL DESIGN RECOMMENDATIONS**

Parameter	Value	
	EI <sub>≤</sub> 50	EI <sub>≤</sub> 90
Active Soil Pressure, A (Fluid Density, Level Backfill)	35 pcf	40 pcf
Active Soil Pressure, A (Fluid Density, 2:1 Sloping Backfill)	45 psf	55 psf
Seismic Pressure, S	15H psf	
At-Rest/Restrained Walls Additional Uniform Pressure (0 to 8 Feet High)	7H psf	
At-Rest/Restrained Walls Additional Uniform Pressure (8+ Feet High)	13H psf	
Expected Expansion Index for the Subject Property	EI <sub>≤</sub> 50	

H equals the height of the retaining portion of the wall

6.7.2 The project retaining walls should be designed as shown in the Retaining Wall Loading Diagram.

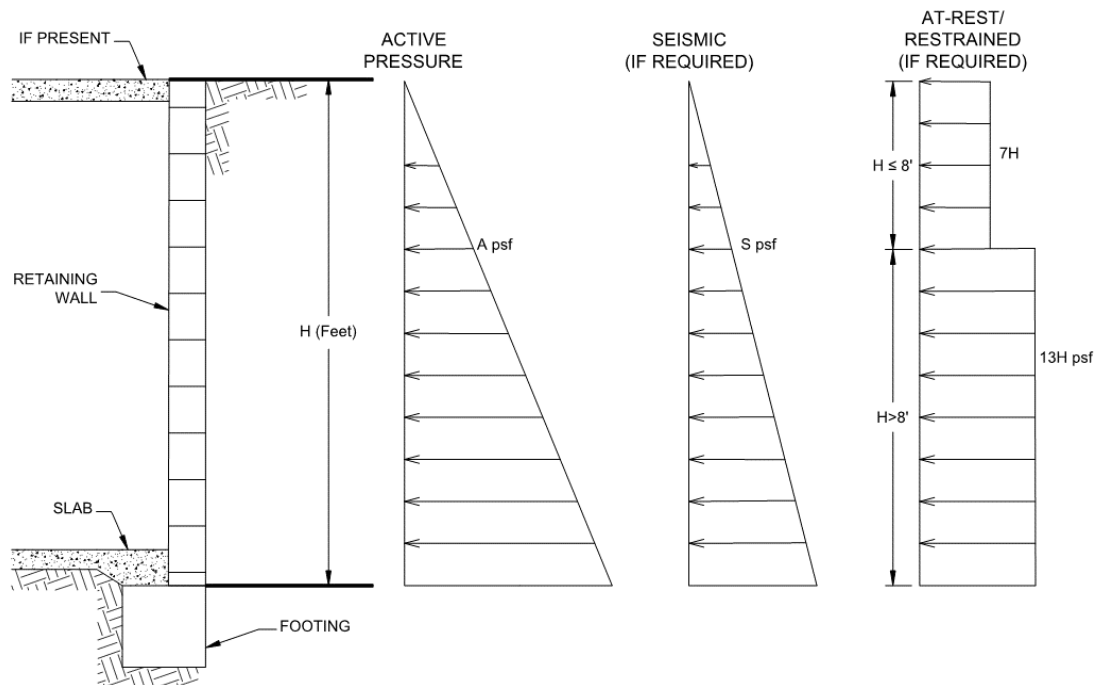

**Retaining Wall Loading Diagram**

- 6.7.3 Unrestrained walls are those that are allowed to rotate more than  $0.001H$  (where  $H$  equals the height of the retaining portion of the wall) at the top of the wall. Where walls are restrained from movement at the top (at-rest condition), an additional uniform pressure of  $7H$  psf should be added to the active soil pressure for walls 8 feet or less. For walls greater than 8 feet tall, an additional uniform pressure of  $13H$  psf should be applied to the wall starting at 8 feet from the top of the wall to the base of the wall. For retaining walls subject to vehicular loads within a horizontal distance equal to two-thirds the wall height, a surcharge equivalent to 2 feet of fill soil should be added.
- 6.7.4 The structural engineer should determine the Seismic Design Category for the project in accordance with Section 1613.2.5 of the 2019 CBC or Section 11.6 of ASCE 7-16. For structures assigned to Seismic Design Category of D, E, or F, retaining walls that support more than 6 feet of backfill should be designed with seismic lateral pressure in accordance with Section 1803.5.12 of the 2019 CBC. The seismic load is dependent on the retained height where  $H$  is the height of the wall, in feet, and the calculated loads result in pounds per square foot (psf) exerted at the base of the wall and zero at the top of the wall. A seismic load of  $17H$  psf should be used for design. We used the peak ground acceleration adjusted for Site Class effects,  $PGA_M$ , of  $0.477g$  calculated from ASCE 7-16 Section 11.8.3 and applied a pseudo-static coefficient of 0.3.
- 6.7.5 Retaining walls should be designed to ensure stability against overturning sliding, and excessive foundation pressure. Where a keyway is extended below the wall base with the intent to engage passive pressure and enhance sliding stability, it is not necessary to consider active pressure on the keyway.
- 6.7.6 Drainage openings through the base of the wall (weep holes) should not be used where the seepage could be a nuisance or otherwise adversely affect the property adjacent to the base of the wall. The recommendations herein assume a properly compacted granular (EI of 50 or less) free-draining backfill material with no hydrostatic forces or imposed surcharge load. The retaining wall should be properly drained as shown in the Typical Retaining Wall Drainage Detail. If conditions different than those described are expected, or if specific drainage details are desired, Geocon Incorporated should be contacted for additional recommendations.

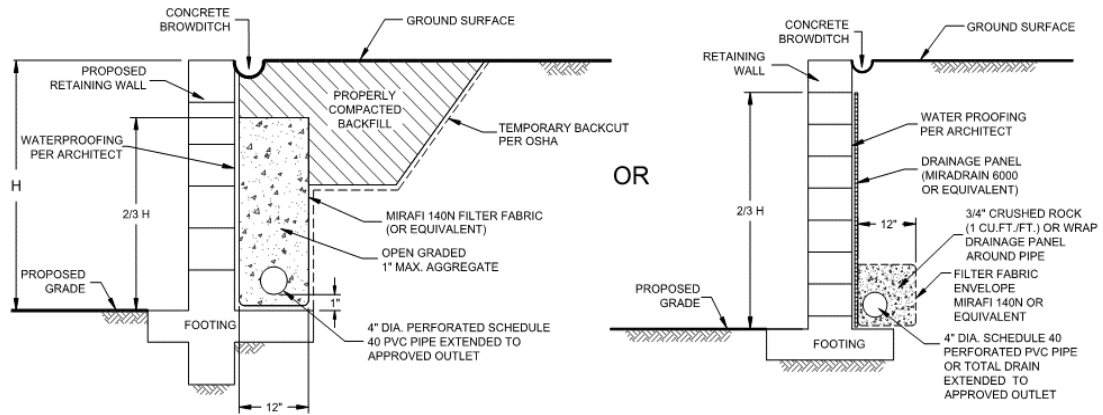

**Typical Retaining Wall Drainage Detail**

6.7.7 The retaining walls may be designed using either the active and restrained (at-rest) loading condition or the active and seismic loading condition as suggested by the structural engineer. Typically, it appears the design of the restrained condition for retaining wall loading may be adequate for the seismic design of the retaining walls. However, the active earth pressure combined with the seismic design load should be reviewed and also considered in the design of the retaining walls.

6.7.8 In general, wall foundations having should be designed in accordance with Table 6.7.2. The proximity of the foundation to the top of a slope steeper than 3:1 could impact the allowable soil bearing pressure. Therefore, retaining wall foundations should be deepened such that the bottom outside edge of the footing is at least 7 feet horizontally from the face of the slope.

**TABLE 6.7.2  
SUMMARY OF RETAINING WALL FOUNDATION RECOMMENDATIONS**

Parameter	Value
Minimum Retaining Wall Foundation Width	12 inches
Minimum Retaining Wall Foundation Depth	12 Inches
Minimum Steel Reinforcement	Per Structural Engineer
Bearing Capacity	2,000 psf
Bearing Capacity Increase	500 psf per additional foot of footing depth
	300 psf per additional foot of footing width
Maximum Bearing Capacity	4,000 psf
Estimated Total Settlement	1 Inch
Estimated Differential Settlement	½ Inch in 40 Feet

- 6.7.9 The recommendations presented herein are generally applicable to the design of rigid concrete or masonry retaining walls. In the event that other types of walls (such as mechanically stabilized earth [MSE] walls, soil nail walls, or soldier pile walls) are planned, Geocon Incorporated should be consulted for additional recommendations.
- 6.7.10 Unrestrained walls will move laterally when backfilled and loading is applied. The amount of lateral deflection is dependent on the wall height, the type of soil used for backfill, and loads acting on the wall. The retaining walls and improvements above the retaining walls should be designed to incorporate an appropriate amount of lateral deflection as determined by the structural engineer.
- 6.7.11 Soil contemplated for use as retaining wall backfill, including import materials, should be identified in the field prior to backfill. At that time, Geocon Incorporated should obtain samples for laboratory testing to evaluate its suitability. Modified lateral earth pressures may be necessary if the backfill soil does not meet the required expansion index or shear strength. City or regional standard wall designs, if used, are based on a specific active lateral earth pressure and/or soil friction angle. In this regard, on-site soil to be used as backfill may or may not meet the values for standard wall designs. Geocon Incorporated should be consulted to assess the suitability of the on-site soil for use as wall backfill if standard wall designs will be used.

## 6.8 Lateral Loading

- 6.8.1 Table 6.8 should be used to help design the proposed structures and improvements to resist lateral loads for the design of footings or shear keys. The allowable passive pressure assumes a horizontal surface extending at least 5 feet, or three times the surface generating the passive pressure, whichever is greater. The upper 12 inches of material in areas not protected by floor slabs or pavement should not be included in design for passive resistance. Where walls are planned adjacent to and/or on descending slopes, a passive pressure of 150 pcf should be used in design.

**TABLE 6.8  
SUMMARY OF LATERAL LOAD DESIGN RECOMMENDATIONS**

Parameter	Value
Passive Pressure Fluid Density	300 pcf
Passive Pressure Fluid Density Adjacent to and/or on Descending Slopes	150 pcf
Coefficient of Friction (Concrete and Soil)	0.35
Coefficient of Friction (Along Vapor Barrier)	0.2 to 0.25*

\* Per manufacturer's recommendations.



6.8.2 The passive and frictional resistant loads can be combined for design purposes. The lateral passive pressures may be increased by one-third when considering transient loads due to wind or seismic forces.

## 6.9 Preliminary Pavement Recommendations

6.9.1 Preliminary pavement recommendations for the streets and parking areas are provided below. The final pavement sections should be based on the R-Value of the subgrade soil encountered at final subgrade elevation. For pavement design we used a laboratory R-Value of 10. Preliminary flexible pavement sections are presented in 6.9.1. We calculated the flexible pavement sections in general conformance with the Caltrans Method of Flexible Pavement Design (Highway Design Manual, Section 608.4) using estimated Traffic Indices (TI) in general accordance with City of Chula Vista guidelines (the City requires that private streets be designed in general accordance with City standards). The project civil engineer or traffic engineer should determine the appropriate Traffic Index (TI) or traffic loading expected on the project for the various pavement areas that will be constructed.

**TABLE 6.9.1  
PRELIMINARY ASPHALT CONCRETE PAVEMENT SECTIONS**

Location	Minimum Traffic Index	Assumed Subgrade R-Value	Asphalt Concrete (inches)	Class 2 Aggregate Base (inches)
Residential Cul-De-Sac	5.0	10	3	9
Residential	6.0	10	3	12.5

6.9.2 Asphalt concrete should conform to Section 203-6 of the *Standard Specifications for Public Works Construction* (Green Book). Cement treated base should conform to Greenbook Section 301-3.3. Class 2 aggregate base materials should conform to Section 26-1.02B of the *Standard Specifications of the State of California, Department of Transportation* (Caltrans).

6.9.3 Prior to placing base material, the subgrade should be scarified, moisture conditioned and recompacted to a minimum of 95 percent relative compaction. The depth of compaction should be at least 12 inches. The base material should be compacted to at least 95 percent relative compaction. Asphalt concrete should be compacted to a density of at least 95 percent of the laboratory Hveem density in accordance with ASTM D 2726.

6.9.4 A rigid Portland Cement concrete (PCC) pavement section should be placed in driveway entrance aprons. The concrete pad for trash truck areas should be large enough such that the

truck wheels will be positioned on the concrete during loading. We calculated the rigid pavement section in general conformance with the procedure recommended by the American Concrete Institute report ACI 330R-08 Guide for Design and Construction of Concrete Parking Lots using the parameters presented in Table 6.9.2.

**TABLE 6.9.2  
PRELIMINARY RIGID PAVEMENT DESIGN PARAMETERS**

Design Parameter	Design Value
Modulus of subgrade reaction, k	50 pci
Modulus of rupture for concrete, $M_R$	500 psi
Traffic Category, TC	A-1 and B
Average daily truck traffic, ADTT	1 and 25

6.9.5 Based on the criteria presented herein, the PCC pavement sections should have a minimum thickness as presented in Table 6.9.3.

**TABLE 6.9.3  
PRELIMINARY RIGID PAVEMENT RECOMMENDATIONS**

Location	Portland Cement Concrete (inches)
Automobile Areas (TC=A-1, ADTT = 1)	5.5
Heavy Truck and Fire Lane Areas (TC=C, ADTT = 100)	7.0

6.9.6 The PCC pavement should be placed over subgrade soil that is compacted to a dry density of at least 95 percent of the laboratory maximum dry density near to slightly above optimum moisture content. For single-family residential lot driveways, 90 percent of the laboratory maximum dry density near to slightly above optimum moisture content is acceptable. This pavement section is based on a minimum concrete compressive strength of approximately 3,200 psi (pounds per square inch).

6.9.7 A thickened edge or integral curb should be constructed on the outside of concrete slabs subjected to wheel loads. The thickened edge should be 1.2 times the slab thickness or a minimum thickness of 2 inches, whichever results in a thicker edge, at the slab edge and taper back to the recommended slab thickness 3 feet behind the face of the slab (e.g., a 7-inch-thick slab would have a 9-inch-thick edge). Reinforcing steel will not be necessary within the concrete for geotechnical purposes with the exception of loading docks, trash bin enclosures, and dowels at construction joints as discussed below.

- 6.9.8 To control the location and spread of concrete shrinkage cracks, crack-control joints (weakened plane joints) should be included in the design of the concrete pavement slab. Crack-control joints should not exceed 30 times the slab thickness with a maximum spacing of 15 feet (e.g., a 7-inch-thick slab would have a 15-foot spacing pattern) and should be sealed with an appropriate sealant to prevent the migration of water through the control joint to the subgrade materials. The depth of the crack-control joints should be determined by the referenced ACI report.
- 6.9.9 To provide load transfer between adjacent pavement slab sections, a trapezoidal-keyed construction joint should be installed. As an alternative to the keyed joint, dowelling is recommended between construction joints. As discussed in the referenced ACI guide, dowels should consist of smooth, 7/8-inch-diameter reinforcing steel 14 inches long embedded a minimum of 6 inches into the slab on either side of the construction joint. Dowels should be located at the midpoint of the slab, spaced at 12 inches on center and lubricated to allow joint movement while still transferring loads. The project structural engineer may provide alternative recommendations for load transfer.
- 6.9.10 The performance of pavement is highly dependent on providing positive surface drainage away from the edge of the pavement. Ponding of water on or adjacent to the pavement will likely result in pavement distress and subgrade failure. Drainage from landscaped areas should be directed to controlled drainage structures. Landscape areas adjacent to the edge of asphalt pavements are not recommended due to the potential for surface or irrigation water to infiltrate the underlying permeable aggregate base and cause distress. Where such a condition cannot be avoided, consideration should be given to incorporating measures that will significantly reduce the potential for subsurface water migration into the aggregate base. If planter islands are planned, the perimeter curb should extend at least 6 inches below the level of the base materials.

## **6.10 Exterior Concrete Flatwork**

- 6.10.1 Exterior concrete flatwork not subject to vehicular traffic should be constructed in accordance with the recommendations presented in Table 6.10. The recommended steel reinforcement would help reduce the potential for cracking.

**TABLE 6.10  
MINIMUM CONCRETE FLATWORK RECOMMENDATIONS**

Expansion Index, EI	Minimum Steel Reinforcement* Options	Minimum Thickness
EI ≤ 90	6x6-W2.9/W2.9 (6x6-6/6) welded wire mesh	4 Inches
	No. 3 Bars 18 inches on center, Both Directions	
EI ≤ 130	4x4-W4.0/W4.0 (4x4-4/4) welded wire mesh	
	No. 4 Bars 12 inches on center, Both Directions	

\* In excess of 8 feet square.

- 6.10.2 Even with the incorporation of the recommendations of this report, the exterior concrete flatwork has a potential to experience some uplift due to expansive soil beneath grade. The steel reinforcement should overlap continuously in flatwork to reduce the potential for vertical offsets within flatwork. Additionally, flatwork should be structurally connected to the curbs, where possible, to reduce the potential for offsets between the curbs and the flatwork.
- 6.10.3 Concrete flatwork should be provided with crack control joints to reduce and/or control shrinkage cracking. Crack control spacing should be determined by the project structural engineer based upon the slab thickness and intended usage. Criteria of the American Concrete Institute (ACI) should be taken into consideration when establishing crack control spacing. Subgrade soil for exterior slabs not subjected to vehicle loads should be compacted in accordance with criteria presented in the grading section prior to concrete placement. Subgrade soil should be properly compacted, and the moisture content of subgrade soil should be verified prior to placing concrete. Base materials will not be required below concrete improvements.
- 6.10.4 The recommendations presented herein are intended to reduce the potential for cracking of exterior slabs as a result of differential movement. However, even with the incorporation of the recommendations presented herein, slabs-on-grade will still crack. The occurrence of concrete shrinkage cracks is independent of the soil supporting characteristics. Their occurrence may be reduced and/or controlled by limiting the slump of the concrete, the use of crack control joints and proper concrete placement and curing. Crack control joints should be spaced at intervals no greater than 12 feet. Literature provided by the Portland Concrete Association (PCA) and American Concrete Institute (ACI) present recommendations for proper concrete mix, construction, and curing practices, and should be incorporated into project construction.

## **6.11 Slope Maintenance**

- 6.11.1 Slopes that are steeper than 3:1 (horizontal:vertical) may, under conditions which are both difficult to prevent and predict, be susceptible to near surface (surficial) slope instability. The instability is typically limited to the outer three feet of a portion of the slope and usually does not directly impact the improvements on the pad areas above or below the slope. The occurrence of surficial instability is more prevalent on fill slopes and is generally preceded by a period of heavy rainfall, excessive irrigation, or the migration of subsurface seepage. The disturbance and/or loosening of the surficial soils, as might result from root growth, soil expansion, or excavation for irrigation lines and slope planting, may also be a significant contributing factor to surficial instability. It is, therefore, recommended that, to the maximum extent practical: (a) disturbed/loosened surficial soils be either removed or properly recompacted, (b) irrigation systems be periodically inspected and maintained to eliminate leaks and excessive irrigation, and (c) surface drains on and adjacent to slopes be periodically maintained to preclude ponding or erosion. Although the incorporation of the above recommendations should reduce the potential for surficial slope instability, it will not eliminate the possibility, and, therefore, it may be necessary to rebuild or repair a portion of the project's slopes in the future.

## **6.12 Storm Water Management**

- 6.12.1 If storm water management devices are not properly designed and constructed, there is a risk for distress to improvements and property located hydrologically down gradient or adjacent to these devices. Factors such as the amount of water being detained, its residence time, and soil permeability have an important effect on seepage transmission and the potential adverse impacts that may occur if the storm water management features are not properly designed and constructed. We have not performed a hydrogeological study at the site. If infiltration of storm water runoff into the subsurface occurs, downstream improvements may be subjected to seeps, springs, slope instability, raised groundwater, movement of foundations and slabs, or other undesirable impacts as a result of water infiltration.
- 6.12.2 We performed an infiltration study on the property. A summary of our study and storm water management recommendations are provided in Appendix C. Based on the results of our study, full and partial infiltration is considered infeasible due to the presence of undocumented fills, low infiltration characteristics, and existing nearby utilities. Basins should utilize a liner to prevent infiltration from causing adverse settlement, migrating to adjacent slopes, utilities, and foundations.

### **6.13 Site Drainage and Moisture Protection**

- 6.13.1 Adequate site drainage is critical to reduce the potential for differential soil movement, erosion and subsurface seepage. Under no circumstances should water be allowed to pond adjacent to footings. The site should be graded and maintained such that surface drainage is directed away from structures in accordance with 2019 CBC 1803.3 or other applicable standards. In addition, surface drainage should be directed away from the top of slopes into swales or other controlled drainage devices. Roof and pavement drainage should be directed into conduits that carry runoff away from the proposed structure.
- 6.13.2 In the case of basement walls or building walls retaining landscaping areas, a water-proofing system should be used on the wall and joints, and a Miradrain drainage panel (or similar) should be placed over the waterproofing. The project architect or civil engineer should provide detailed specifications on the plans for all waterproofing and drainage.
- 6.13.3 Underground utilities should be leak free. Utility and irrigation lines should be checked periodically for leaks, and detected leaks should be repaired promptly. Detrimental soil movement could occur if water is allowed to infiltrate the soil for prolonged periods of time.
- 6.13.4 Landscaping planters adjacent to paved areas are not recommended due to the potential for surface or irrigation water to infiltrate the pavement's subgrade and base course. We recommend that subdrains to collect excess irrigation water and transmit it to drainage structures, or impervious above-grade planter boxes be used. In addition, where landscaping is planned adjacent to the pavement, we recommend construction of a cutoff wall along the edge of the pavement that extends at least 6 inches below the bottom of the base material.

### **6.14 Grading and Foundation Plan Review**

- 6.14.1 Geocon Incorporated should review the grading plans and foundation plans for the project prior to final design submittal to evaluate whether additional analyses and/or recommendations are required.

## LIMITATIONS AND UNIFORMITY OF CONDITIONS

1. The firm that performed the geotechnical investigation for the project should be retained to provide testing and observation services during construction to provide continuity of geotechnical interpretation and to check that the recommendations presented for geotechnical aspects of site development are incorporated during site grading, construction of improvements, and excavation of foundations. If another geotechnical firm is selected to perform the testing and observation services during construction operations, that firm should prepare a letter indicating their intent to assume the responsibilities of project geotechnical engineer of record. A copy of the letter should be provided to the regulatory agency for their records. In addition, that firm should provide revised recommendations concerning the geotechnical aspects of the proposed development, or a written acknowledgement of their concurrence with the recommendations presented in our report. They should also perform additional analyses deemed necessary to assume the role of Geotechnical Engineer of Record.
2. The recommendations of this report pertain only to the site investigated and are based upon the assumption that the soil conditions do not deviate from those disclosed in the investigation. If any variations or undesirable conditions are encountered during construction, or if the proposed construction will differ from that anticipated herein, Geocon Incorporated should be notified so that supplemental recommendations can be given. The evaluation or identification of the potential presence of hazardous or corrosive materials was not part of the scope of services provided by Geocon Incorporated.
3. This report is issued with the understanding that it is the responsibility of the owner or his representative to ensure that the information and recommendations contained herein are brought to the attention of the architect and engineer for the project and incorporated into the plans, and the necessary steps are taken to see that the contractor and subcontractors carry out such recommendations in the field.
4. The findings of this report are valid as of the present date. However, changes in the conditions of a property can occur with the passage of time, whether they be due to natural processes or the works of man on this or adjacent properties. In addition, changes in applicable or appropriate standards may occur, whether they result from legislation or the broadening of knowledge. Accordingly, the findings of this report may be invalidated wholly or partially by changes outside our control. Therefore, this report is subject to review and should not be relied upon after a period of three years.

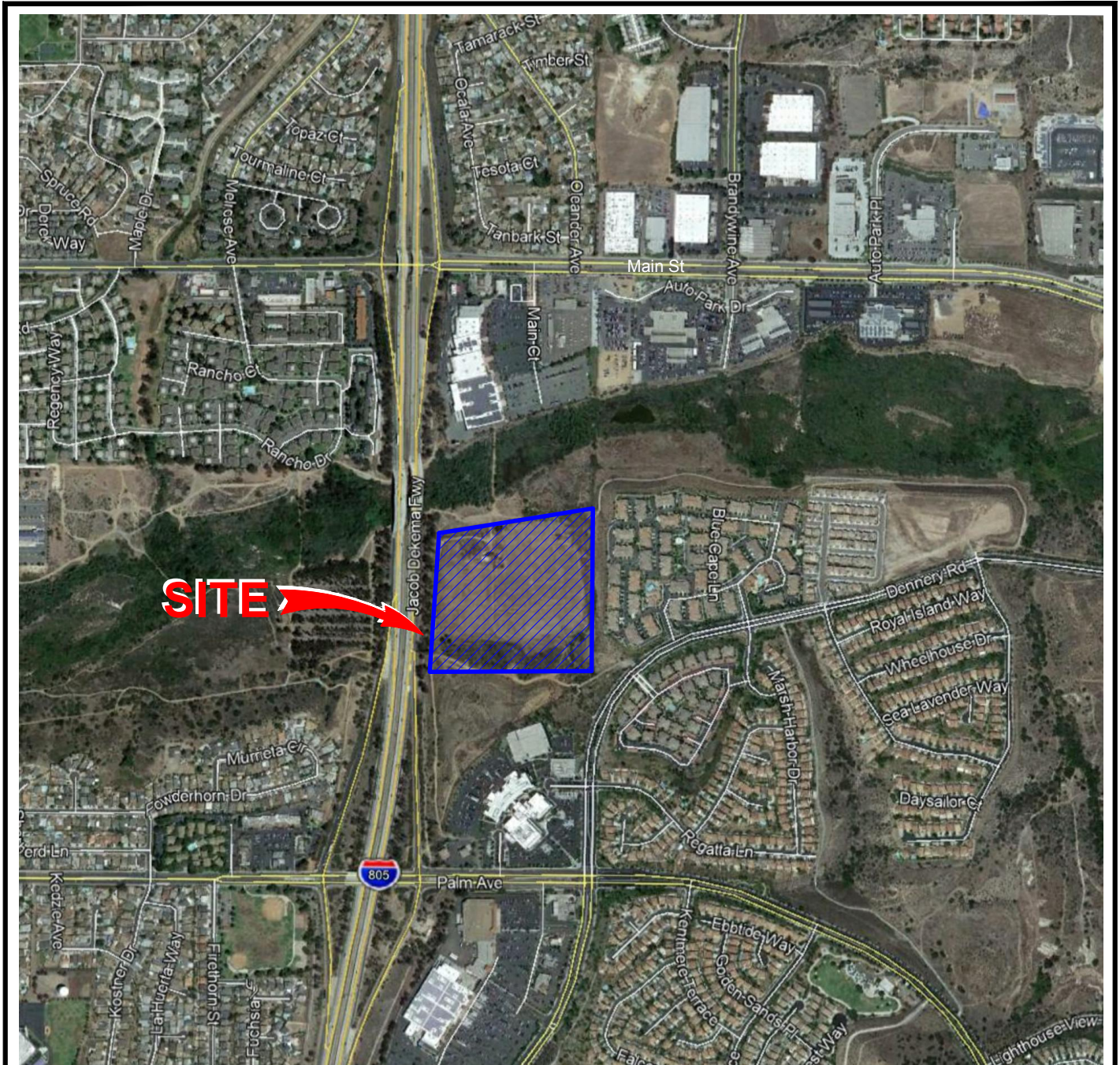

THE GEOGRAPHICAL INFORMATION MADE AVAILABLE FOR DISPLAY WAS PROVIDED BY GOOGLE EARTH, SUBJECT TO A LICENSING AGREEMENT. THE INFORMATION IS FOR ILLUSTRATIVE PURPOSES ONLY; IT IS NOT INTENDED FOR CLIENT'S USE OR RELIANCE AND SHALL NOT BE REPRODUCED BY CLIENT. CLIENT SHALL INDEMNIFY, DEFEND AND HOLD HARMLESS GEOCON FROM ANY LIABILITY INCURRED AS A RESULT OF SUCH USE OR RELIANCE BY CLIENT.



NO SCALE

### VICINITY MAP

**GEOCON**  
INCORPORATED



GEOTECHNICAL ■ ENVIRONMENTAL ■ MATERIALS  
6960 FLANDERS DRIVE - SAN DIEGO, CALIFORNIA 92121 - 2974  
PHONE 858 558-6900 - FAX 858 558-6159

NAKANO  
CHULA VISTA, CALIFORNIA

RM / AML	DSK/GTYPD	DATE 09 - 18 - 2020	PROJECT NO. 07516 - 42 - 02	FIG. 1
----------	-----------	---------------------	-----------------------------	--------



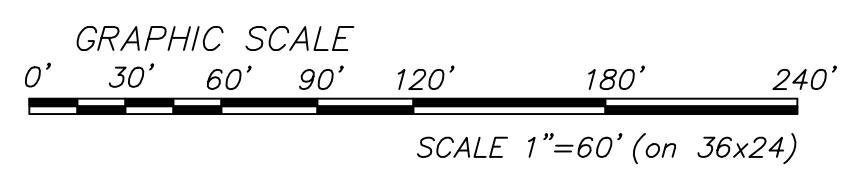
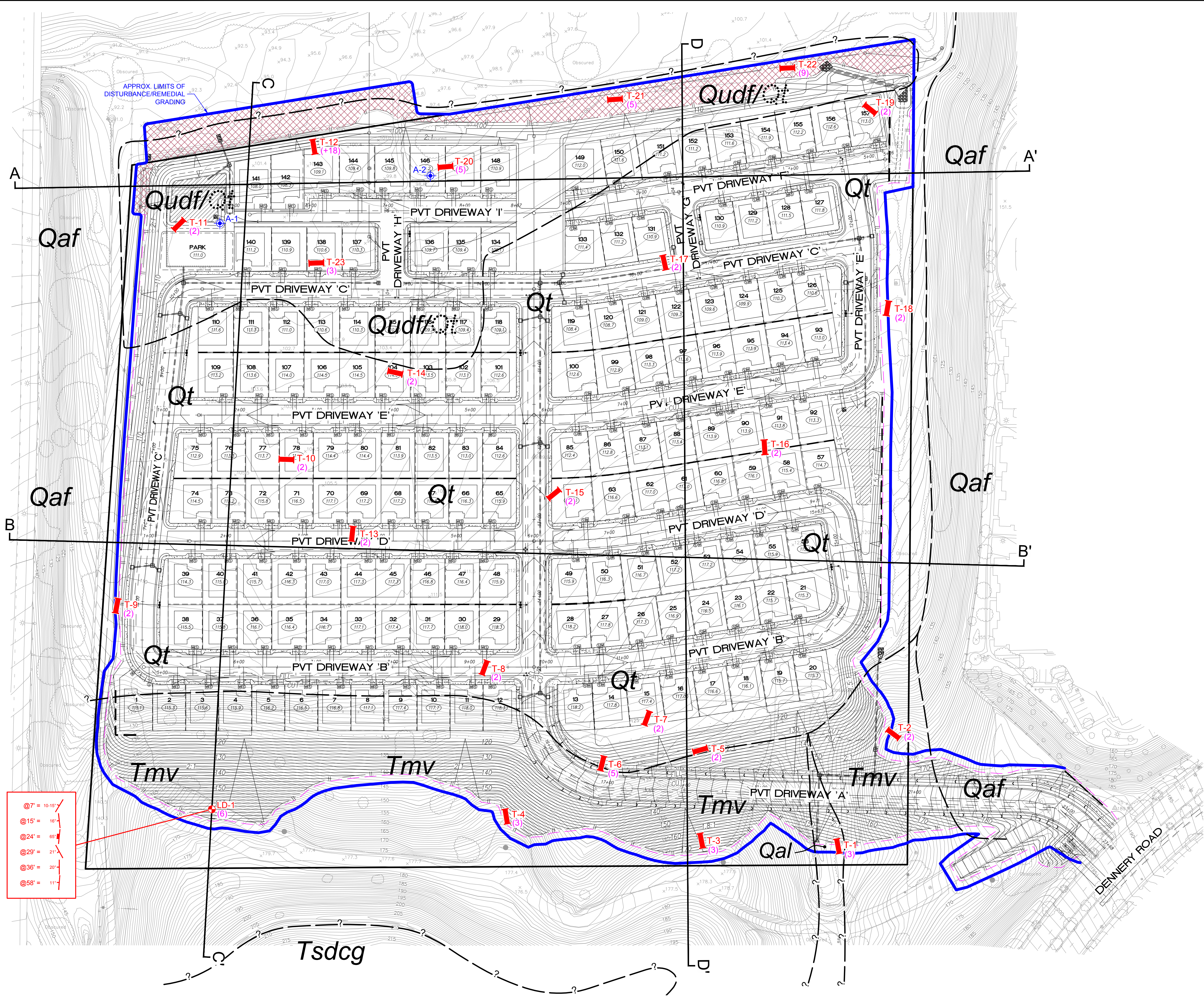

**GEOCON LEGEND**

- Qudf* ..... UNDOCUMENTED FILL
- Qaf* ..... ARTIFICIAL FILL
- Qal* ..... ALLUVIUM
- Qt* ..... TERRACE DEPOSITS  
(Dotted Where Buried)
- Tsdcg* ..... SAN DIEGO FORMATION (Conglomerate)
- Tmv* ..... MISSION VALLEY FORMATION
- ..... APPROX. LOCATION OF GEOLOGIC CONTACT  
(Queried Where Uncertain)
- LD-1 ..... APPROX. LOCATION OF BORING
- A-2 ..... APPROX. LOCATION OF INFILTRATION TEST
- (5) ..... APPROX. DEPTH OF REMEDIAL GRADING (in Feet, MSL)
- D ..... APPROX. LOCATION OF GEOLOGIC CROSS SECTION

<b>GEOLOGIC MAP</b>		
NAKANO CHULA VISTA, CALIFORNIA		
<b>GEOCON</b> INCORPORATED GEOTECHNICAL ■ ENVIRONMENTAL ■ MATERIALS 6940 ANDERS DRIVE ■ SAN DIEGO, CALIFORNIA 92121-2974 PHONE 858.558.4900 ■ FAX 858.558.4159	SCALE 1" = 60'	DATE 09 - 18 - 2020
PROJECT NO. 07516 - 42 - 02	FIGURE	<b>2</b>
SHEET 1 OF 1		

Printed 09/17/2020 10:27AM | By ALVIN LADRILLON | File Location V:\PROJ\07516-42-02 (Nakano)\SHEET\07516-42-02-02 Map 20.dwg

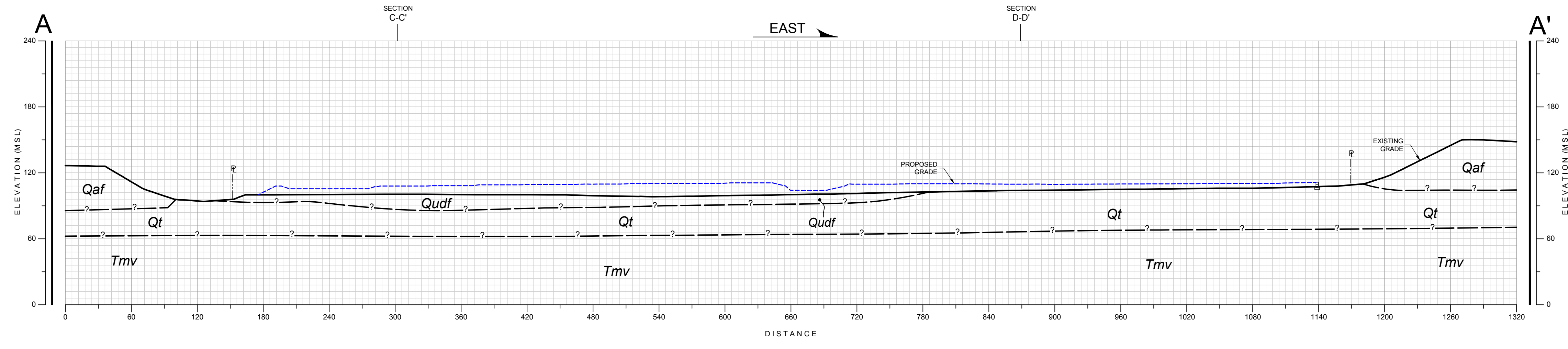

**GEOLOGIC CROSS-SECTION A-A'**  
SCALE: 1" = 60' (Vert. = Horiz.)

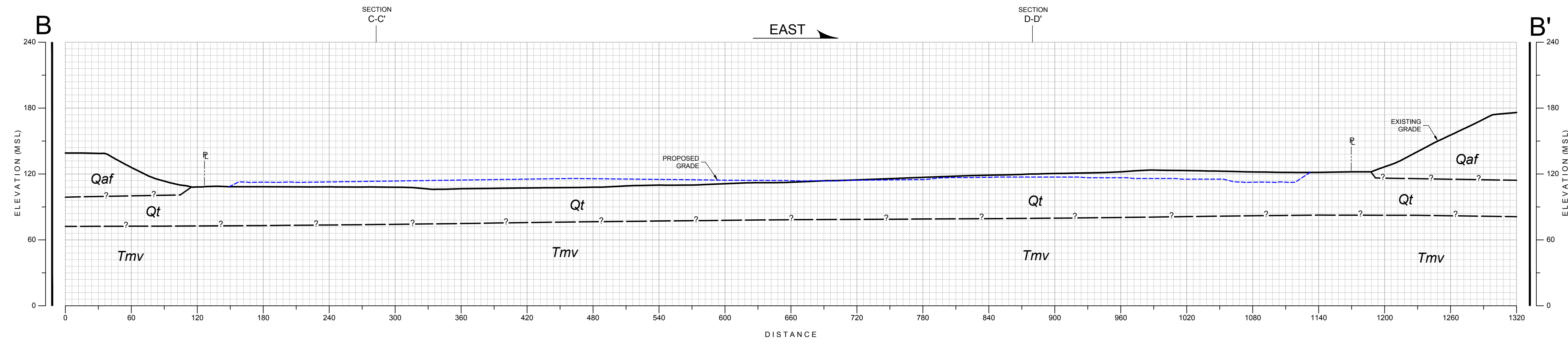

**GEOLOGIC CROSS-SECTION B-B'**  
SCALE: 1" = 60' (Vert. = Horiz.)

<b>GEOLOGIC CROSS SECTION</b>				
NAKANO CHULA VISTA, CALIFORNIA				
<b>GEOCON</b> <small>INCORPORATED</small> GEOTECHNICAL ■ ENVIRONMENTAL ■ MATERIALS 6940 SANDERS DRIVE ■ SAN DIEGO, CALIFORNIA 92121-2974 PHONE 858.558.4900 ■ FAX 858.558.4159	SCALE 1" = 60'	DATE 09 - 18 - 2020	<b>3</b>	
	PROJECT NO. 07516 - 42 - 02			FIGURE
	SHEET 1 OF 2			

PlotNo:001170205 10.38AM | By ALVIN LADRILLANO | File Location: Y:\PROJECTS\07516-42-02 (NAKANO)\SHEETS\07516-42-02 Section 20.dwg

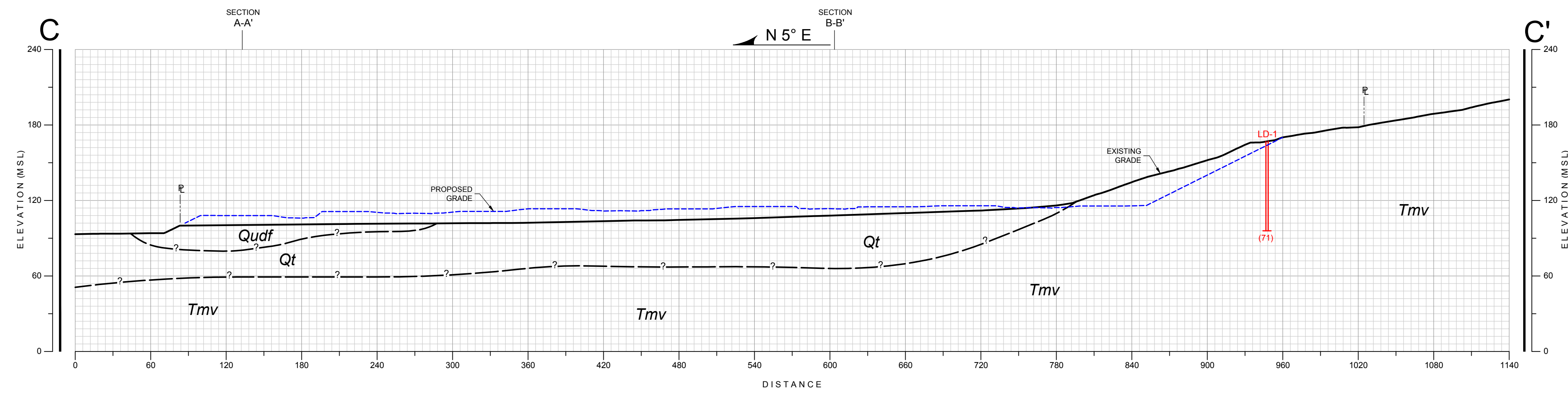

**GEOLOGIC CROSS-SECTION C-C'**  
SCALE: 1" = 60' (Vert. = Horiz.)

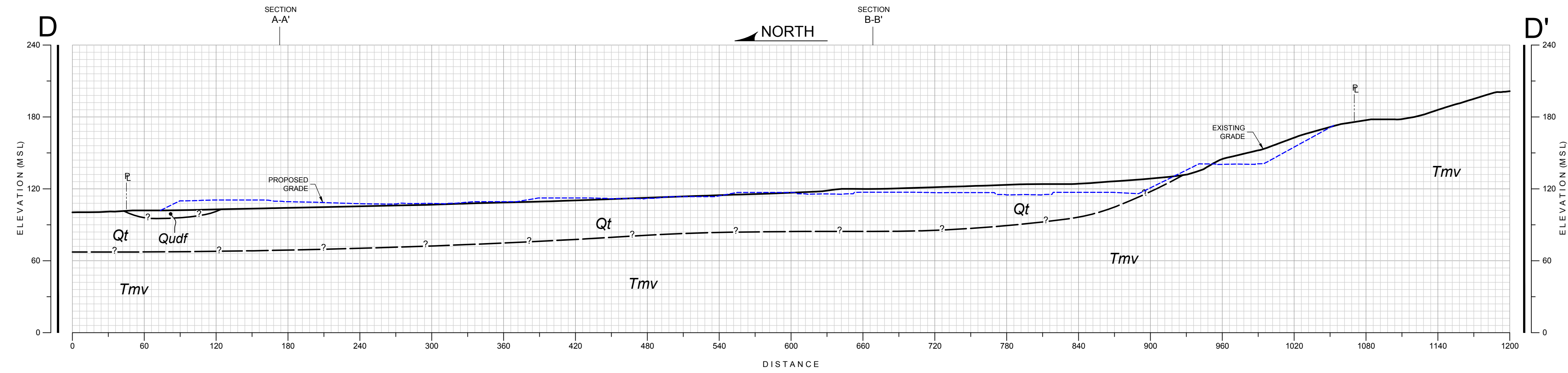

**GEOLOGIC CROSS-SECTION D-D'**  
SCALE: 1" = 60' (Vert. = Horiz.)

<b>GEOLOGIC CROSS SECTION</b>			
NAKANO CHULA VISTA, CALIFORNIA			
<b>GEOCON</b> INCORPORATED <small>GEOTECHNICAL ■ ENVIRONMENTAL ■ MATERIALS</small> <small>6940 SANDERS DRIVE ■ SAN DIEGO, CALIFORNIA 92121-2974</small> <small>PHONE 858.558.4900 ■ FAX 858.558.4159</small>	SCALE	DATE	<b>4</b>
	PROJECT NO.	07516 - 42 - 02	
	SHEET	2 OF 2	
		1" = 60'	09 - 18 - 2020

Plotfile:001170205 10.38AM | By ALVIN LADRILLON | File Location: Y:\PROJECTS\07516-42-02 (Nakano)\SHEETS\07516-42-02 (Section 2).dwg

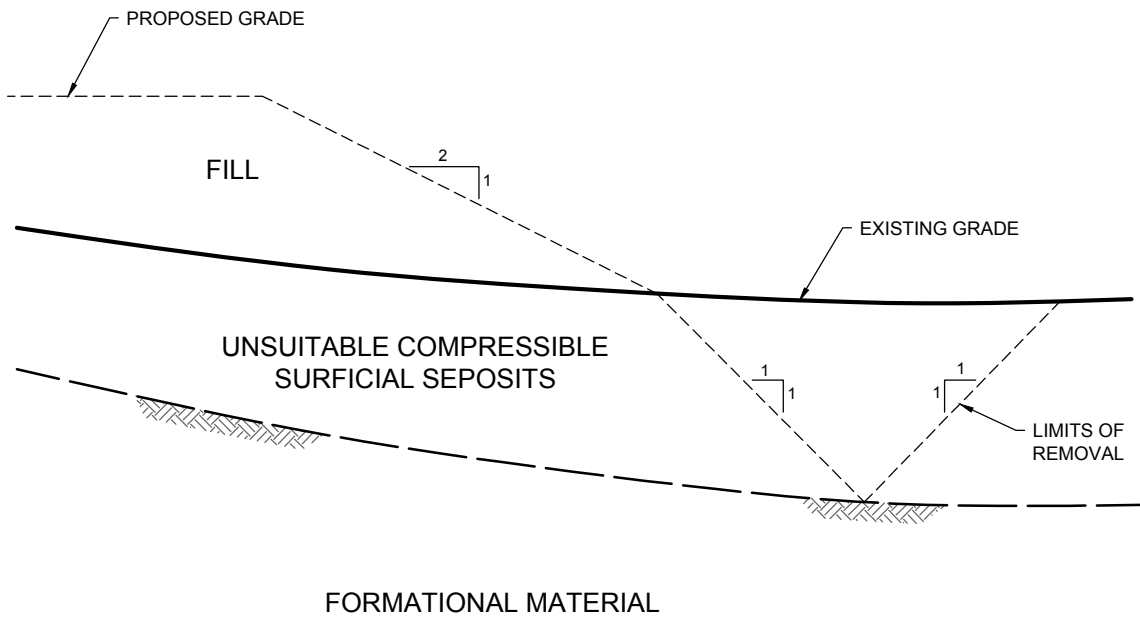

NOT TO SCALE

**NOTE:**

SLOPE OF BACKCUT MAY BE STEEPENED WITH THE APPROVAL OF THE PROJECT ENGINEER/GEOLOGIST WHERE BOUNDARY CONSTRAINTS LIMIT EXTENT OF REMOVALS

NO SCALE

**CONSTRUCTION DETAIL FOR LATERAL EXTENT OF REMOVAL**

**GEOCON**  
INCORPORATED



GEOTECHNICAL ■ ENVIRONMENTAL ■ MATERIALS  
6960 FLANDERS DRIVE - SAN DIEGO, CALIFORNIA 92121 - 2974  
PHONE 858 558-6900 - FAX 858 558-6159

**NAKANO**  
**CHULA VISTA, CALIFORNIA**

RM / AML

DSK/GTYPD

DATE 09 - 18 - 2020

PROJECT NO. 07516 - 42 - 02

FIG. 5

ASSUMED CONDITIONS :

SLOPE HEIGHT	H = 55 feet
SLOPE INCLINATION	2 : 1 (Horizontal : Vertical)
TOTAL UNIT WEIGHT OF SOIL	$\gamma_t = 120$ pounds per cubic foot
ANGLE OF INTERNAL FRICTION	$\phi = 30$ degrees
APPARENT COHESION	C = 675 pounds per square foot
NO SEEPAGE FORCES	

ANALYSIS :

$\lambda_{c\phi} = \frac{\gamma_t H \tan \phi}{C}$	EQUATION (3-3), REFERENCE 1
FS = $\frac{NcfC}{\gamma_t H}$	EQUATION (3-2), REFERENCE 1
$\lambda_{c\phi} = 5.6$	CALCULATED USING EQ. (3-3)
Ncf = 22	DETERMINED USING FIGURE 10, REFERENCE 2
FS = 2.2	FACTOR OF SAFETY CALCULATED USING EQ. (3-2)

REFERENCES :

- 1.....Janbu, N., Stability Analysis of Slopes with Dimensionless Parameters, Harvard Soil Mechanics, Series No. 46, 1954
- 2.....Janbu, N., Discussion of J.M. Bell, Dimensionless Parameters for Homogeneous Earth Slopes, Journal of Soil Mechanics and Foundation Design, No. SM6, November 1967.

SLOPE STABILITY ANALYSIS - CUT SLOPES

**GEOCON**  
INCORPORATED



GEOTECHNICAL ■ ENVIRONMENTAL ■ MATERIALS  
6960 FLANDERS DRIVE - SAN DIEGO, CALIFORNIA 92121 - 2974  
PHONE 858 558-6900 - FAX 858 558-6159

NAKANO  
CHULA VISTA, CALIFORNIA

RM / AML

DSK/GTYPD

DATE 09 - 18 - 2020

PROJECT NO. 07516 - 42 - 02

FIG. 6

ASSUMED CONDITIONS :

SLOPE HEIGHT	H = 120 feet
SLOPE INCLINATION	2.5 : 1 (Horizontal : Vertical)
TOTAL UNIT WEIGHT OF SOIL	$\gamma_t = 120$ pounds per cubic foot
ANGLE OF INTERNAL FRICTION	$\phi = 30$ degrees
APPARENT COHESION	C = 675 pounds per square foot
NO SEEPAGE FORCES	

ANALYSIS :

$\lambda_{c\phi} = \frac{\gamma_t H \tan \phi}{C}$	EQUATION (3-3), REFERENCE 1
FS = $\frac{NcfC}{\gamma_t H}$	EQUATION (3-2), REFERENCE 1
$\lambda_{c\phi} = 12.3$	CALCULATED USING EQ. (3-3)
Ncf = 42	DETERMINED USING FIGURE 10, REFERENCE 2
FS = 2.0	FACTOR OF SAFETY CALCULATED USING EQ. (3-2)

REFERENCES :

- 1.....Janbu, N., Stability Analysis of Slopes with Dimensionless Parameters, Harvard Soil Mechanics, Series No. 46, 1954
- 2.....Janbu, N., Discussion of J.M. Bell, Dimensionless Parameters for Homogeneous Earth Slopes, Journal of Soil Mechanics and Foundation Design, No. SM6, November 1967.

SLOPE STABILITY ANALYSIS - NATIVE HILLSIDE

**GEOCON**  
INCORPORATED



GEOTECHNICAL ■ ENVIRONMENTAL ■ MATERIALS  
6960 FLANDERS DRIVE - SAN DIEGO, CALIFORNIA 92121 - 2974  
PHONE 858 558-6900 - FAX 858 558-6159

NAKANO  
CHULA VISTA, CALIFORNIA

RM / AML

DSK/GTYPD

DATE 09 - 18 - 2020

PROJECT NO. 07516 - 42 - 02

FIG. 7



ASSUMED CONDITIONS :

SLOPE HEIGHT	H = Infinite
DEPTH OF SATURATION	Z = 4 feet
SLOPE INCLINATION	2 : 1 (Horizontal : Vertical)
SLOPE ANGLE	i = 26.6 degrees
UNIT WEIGHT OF WATER	$\gamma_w$ = 62.4 pounds per cubic foot
TOTAL UNIT WEIGHT OF SOIL	$\gamma_t$ = 125 pounds per cubic foot
ANGLE OF INTERNAL FRICTION	$\phi$ = 27 degrees
APPARENT COHESION	C = 300 pounds per square foot

SLOPE SATURATED TO VERTICAL DEPTH Z BELOW SLOPE FACE

SEEPAGE FORCES PARALLEL TO SLOPE FACE

ANALYSIS :

$$FS = \frac{C + (\gamma_t - \gamma_w) Z \cos^2 i \tan \phi}{\gamma_t Z \sin i \cos i} = 2.0$$

REFERENCES :

- 1.....Haefeli, R. *The Stability of Slopes Acted Upon by Parallel Seepage*, Proc. Second International Conference, SMFE, Rotterdam, 1948, 1, 57-62
- 2.....Skempton, A. W., and F.A. Delory, *Stability of Natural Slopes in London Clay*, Proc. Fourth International Conference, SMFE, London, 1957, 2, 378-81

SURFICIAL SLOPE STABILITY ANALYSIS

**GEOCON**  
INCORPORATED



GEOTECHNICAL ■ ENVIRONMENTAL ■ MATERIALS  
6960 FLANDERS DRIVE - SAN DIEGO, CALIFORNIA 92121 - 2974  
PHONE 858 558-6900 - FAX 858 558-6159

NAKANO  
CHULA VISTA, CALIFORNIA

RM / AML

DSK/GTYPD

DATE 09 - 18 - 2020

PROJECT NO. 07516 - 42 - 02

FIG. 9



APPENDIX

A

## APPENDIX A

### FIELD INVESTIGATION

Our original field investigation performed on April 14, 2005, consisted of a site reconnaissance and logging of exploratory trenches excavated with a rubber-tired backhoe. The approximate locations of the exploratory trenches are shown on Figure 2. The backhoe trenches were excavated to depths between 2 and 18 feet below the existing ground surface using a JD 305 backhoe equipped with a 24-inch-wide bucket.

Our recent field investigation performed on January 3, 2020, consisted of a site reconnaissance and logging of one large diameter boring excavated with a truck mounted EZ-Bore drill rig using a 30-inch diameter bucket auger. The boring was advanced to a depth of 70 feet below existing grades near the top of slope on the south side of the site. The boring was backfilled in accordance with County of San Diego guidelines.







For the large diameter boring, the samplers were driven 12 inches into the bottom of the excavations with the use of a telescoping Kelly bar. The weight of the Kelly bar (4,500 lbs. maximum) drives the sampler and varies with depth. The height of drop is usually 12 inches. Blow counts are recorded for every 12 inches the sampler is driven. The penetration resistance values shown on the boring logs are shown in terms of blows per foot. These values are not to be taken as N-values; adjustments have not been applied. Elevations shown on the boring logs were determined either from a topographic map or by using a benchmark.

The soil conditions encountered in the trenches were visually examined, classified, and logged in general conformance with the American Society for Testing and Materials (ASTM) Practice for Description and Identification of Soils (Visual-Manual Procedure D 2488-00). The logs of the exploratory trenches are presented on Figures A-1 through A-23. The logs depict the various soil types encountered and indicate the depths at which samples were obtained.

DEPTH IN FEET	SAMPLE NO.	LITHOLOGY	GROUNDWATER	SOIL CLASS (USCS)	<b>BORING LD 1</b>		PENETRATION RESISTANCE (BLOWS/FT.)	DRY DENSITY (P.C.F.)	MOISTURE CONTENT (%)
					ELEV. (MSL.) <u>+/-168'</u>	DATE COMPLETED <u>01-03-2020</u>			
					EQUIPMENT <u>EZ BORE</u>		BY: <u>R. ADAMS</u>		
MATERIAL DESCRIPTION									
0				SM	<b>UNDOCUMENTED FILL (Qudf)</b> Loose to medium dense, damp, grayish-brown, Silty SAND; some cobble, trace clay				
2									
4				SC	<b>COLLUVIUM (Qco)</b> Medium dense, damp, brown and grayish brown, Clayey SAND; some gravel and cobble. Cobble is sub-rounded up to 10-inch in width				
6									
8				SM	<b>MISSION VALLEY FORMATION (Tmv)</b> Irregular contact at 6-7 feet Medium dense to dense, damp, pale yellowish-orange to whitish orange, very fine grained Silty SAND; micaceous, friable, massive to weakly laminated/bedded				
10	LD1-1				-At 7 feet: thin 2-inch thick gravel bed. Gravel is sub-rounded 1/2-inch to 3-inch in width. Bedding: N30E/10-15°W (undulatory)		3		
12									
14									
16					-At 15 feet: grayish white 3/4-inch thick sand bed. Bedding: N5W/16°W				
18					-At 17 feet: 6-inch thick clayey sand/gravel bed; gravel sub-rounded 1/2 to 4-inch in width				
20	LD1-2			SM	Dense, damp, whitish gray, very fine grained Silty SAND; highly micaceous, abundant lithic grains, weakly to moderately laminated		3		
22									
24					-At 24 feet: 1/4-1/2-inch sand filled fractures. N5E/65°E				
26									
28					-At 29 feet: bedding N31W/21°W				

**Figure A-1,**  
**Log of Boring LD 1, Page 1 of 3**

07516-42-02.GPJ

SAMPLE SYMBOLS	 ... SAMPLING UNSUCCESSFUL	 ... STANDARD PENETRATION TEST	 ... DRIVE SAMPLE (UNDISTURBED)
	 ... DISTURBED OR BAG SAMPLE	 ... CHUNK SAMPLE	 ... WATER TABLE OR SEEPAGE

NOTE: THE LOG OF SUBSURFACE CONDITIONS SHOWN HEREON APPLIES ONLY AT THE SPECIFIC BORING OR TRENCH LOCATION AND AT THE DATE INDICATED. IT IS NOT WARRANTED TO BE REPRESENTATIVE OF SUBSURFACE CONDITIONS AT OTHER LOCATIONS AND TIMES.

DEPTH IN FEET	SAMPLE NO.	LITHOLOGY	GROUNDWATER	SOIL CLASS (USCS)	<b>BORING LD 1</b>		PENETRATION RESISTANCE (BLOWS/FT.)	DRY DENSITY (P.C.F.)	MOISTURE CONTENT (%)	
					ELEV. (MSL.) <u>+/-168'</u>	DATE COMPLETED <u>01-03-2020</u>				
					EQUIPMENT <u>EZ BORE</u> BY: <u>R. ADAMS</u>					
					<b>MATERIAL DESCRIPTION</b>					
30	LD1-3			SM	-At 30 feet: becomes dense to very dense		6			
32										
34										
36						-At 36 feet: small 12-inch wide clay filled load structure (small channel). Bedding: N-S/20°W				
38						-At 38 feet: 4-inch thick gray brown sandy clay bed; not remolded				
40	LD1-4					-At 39 feet: dense, damp, whitish gray, medium coarse sand bed; trace sub-rounded gravel up to 4-inch in width -At 40 feet: few oval white-sand filled burrows (krotovina) 2 to 4-inch diameter.		7		
42						-At 41 feet: 1/4-inch wide, high angle sand filled fracture with partial caliche infill.				
44										
46						-At 45 feet: becomes white, fine to medium grained silty sand				
48										
50	LD1-5					-No sample recovery at 50 feet		10		
52	LD1-5							15		
54										
56										
58						-At 58 feet: bedding N5E/11°W				

**Figure A-1,**  
**Log of Boring LD 1, Page 2 of 3**

07516-42-02.GPJ

SAMPLE SYMBOLS	... SAMPLING UNSUCCESSFUL	... STANDARD PENETRATION TEST	... DRIVE SAMPLE (UNDISTURBED)
	... DISTURBED OR BAG SAMPLE	... CHUNK SAMPLE	... WATER TABLE OR SEEPAGE

NOTE: THE LOG OF SUBSURFACE CONDITIONS SHOWN HEREON APPLIES ONLY AT THE SPECIFIC BORING OR TRENCH LOCATION AND AT THE DATE INDICATED. IT IS NOT WARRANTED TO BE REPRESENTATIVE OF SUBSURFACE CONDITIONS AT OTHER LOCATIONS AND TIMES.



DEPTH IN FEET	SAMPLE NO.	LITHOLOGY	GROUNDWATER	SOIL CLASS (USCS)	<b>BORING LD 1</b> ELEV. (MSL.) <u>+/-168'</u> DATE COMPLETED <u>01-03-2020</u> EQUIPMENT <u>EZ BORE</u> BY: <u>R. ADAMS</u>	PENETRATION RESISTANCE (BLOWS/FT.)	DRY DENSITY (P.C.F.)	MOISTURE CONTENT (%)
60					MATERIAL DESCRIPTION Dense to very dense, damp, white to orange-white Silty, fine to medium SAND; trace gravel, laminated and weakly bedded, friable			
62								
64								
66								
68								
70	LD1-6			SM		10		
					TERMINATED AT 71 FEET No groundwater encountered Backfilled 01-03-2020			

**Figure A-1,**  
**Log of Boring LD 1, Page 3 of 3**

07516-42-02.GPJ



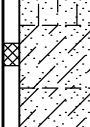



SAMPLE SYMBOLS		... SAMPLING UNSUCCESSFUL		... STANDARD PENETRATION TEST		... DRIVE SAMPLE (UNDISTURBED)
		... DISTURBED OR BAG SAMPLE		... CHUNK SAMPLE		... WATER TABLE OR SEEPAGE

NOTE: THE LOG OF SUBSURFACE CONDITIONS SHOWN HEREON APPLIES ONLY AT THE SPECIFIC BORING OR TRENCH LOCATION AND AT THE DATE INDICATED. IT IS NOT WARRANTED TO BE REPRESENTATIVE OF SUBSURFACE CONDITIONS AT OTHER LOCATIONS AND TIMES.

DEPTH IN FEET	SAMPLE NO.	LITHOLOGY	GROUNDWATER	SOIL CLASS (USCS)	TRENCH T 1		PENETRATION RESISTANCE (BLOWS/FT.)	DRY DENSITY (P.C.F.)	MOISTURE CONTENT (%)
					ELEV. (MSL.) 142'	DATE COMPLETED 04-14-2005			
					EQUIPMENT JD 305 BY: C. JENSEN				
MATERIAL DESCRIPTION									
0	T1-1			SM	ALLUVIUM Loose, humid, light brown, Silty, fine-grained SAND with roots				
2				SC					
4	T1-2			SC	Moderately dense, moist to wet, brown, Clayey SAND with roots and gravel				
6				SC/CL	TERRACE DEPOSIT Stiff, moist, reddish brown, yellow, gray and black, Cobbly, Clayey GRAVEL with little fine- to coarse-grained sand, with angular to subrounded gravel and cobble up to 6" diameter				
8				SP	Dense to very dense, damp, reddish brown, Cobbly SAND with cobble up to 6" diameter				
10	TRENCH TERMINATED AT 10 FEET								

**Figure A-2,**  
**Log of Trench T 1, Page 1 of 1**

07516-42-02.GPJ







SAMPLE SYMBOLS		... SAMPLING UNSUCCESSFUL		... STANDARD PENETRATION TEST		... DRIVE SAMPLE (UNDISTURBED)
		... DISTURBED OR BAG SAMPLE		... CHUNK SAMPLE		... WATER TABLE OR SEEPAGE

NOTE: THE LOG OF SUBSURFACE CONDITIONS SHOWN HEREON APPLIES ONLY AT THE SPECIFIC BORING OR TRENCH LOCATION AND AT THE DATE INDICATED. IT IS NOT WARRANTED TO BE REPRESENTATIVE OF SUBSURFACE CONDITIONS AT OTHER LOCATIONS AND TIMES.

DEPTH IN FEET	SAMPLE NO.	LITHOLOGY	GROUNDWATER	SOIL CLASS (USCS)	<b>TRENCH T 2</b>		PENETRATION RESISTANCE (BLOWS/FT.)	DRY DENSITY (P.C.F.)	MOISTURE CONTENT (%)
					ELEV. (MSL.) <u>160'</u>	DATE COMPLETED <u>04-14-2005</u>			
					EQUIPMENT <u>JD 305</u> BY: <u>C. JENSEN</u>				
MATERIAL DESCRIPTION									
0				SC	<b>TOPSOIL</b> Loose to moderately dense, dry, reddish brown, Clayey SAND with gravel, cobbles and roots				
2				CL	<b>TERRACE DEPOSITS</b> Strong to very strong, humid, reddish brown, Clayey, CONGLOMERATE, very difficult digging				
					TRENCH TERMINATED AT 2 FEET				

**Figure A-3,**  
**Log of Trench T 2, Page 1 of 1**

07516-42-02.GPJ

SAMPLE SYMBOLS	 ... SAMPLING UNSUCCESSFUL	 ... STANDARD PENETRATION TEST	 ... DRIVE SAMPLE (UNDISTURBED)
	 ... DISTURBED OR BAG SAMPLE	 ... CHUNK SAMPLE	 ... WATER TABLE OR SEEPAGE

NOTE: THE LOG OF SUBSURFACE CONDITIONS SHOWN HEREON APPLIES ONLY AT THE SPECIFIC BORING OR TRENCH LOCATION AND AT THE DATE INDICATED. IT IS NOT WARRANTED TO BE REPRESENTATIVE OF SUBSURFACE CONDITIONS AT OTHER LOCATIONS AND TIMES.

DEPTH IN FEET	SAMPLE NO.	LITHOLOGY	GROUNDWATER	SOIL CLASS (USCS)	<b>TRENCH T 3</b>		PENETRATION RESISTANCE (BLOWS/FT.)	DRY DENSITY (P.C.F.)	MOISTURE CONTENT (%)
					ELEV. (MSL.) <u>170'</u>	DATE COMPLETED <u>04-14-2005</u>			
					EQUIPMENT <u>JD 305</u> BY: <u>C. JENSEN</u>				
MATERIAL DESCRIPTION									
0	T3-1			GP	<b>TOPSOIL</b> Loose, dry, brown, Sandy COBBLE with cobbles up to 6" diameter with roots				
2				CL	Firm, damp, brown, Sandy CLAY with roots				
4	T3-2			SM	<b>MISSION VALLEY FORMATION</b> Moderately dense, weak, humid, tan, Silty, very fine-grained SAND, porous				
6				SM	Dense, humid, weak to friable, deeply weathered, humid, light reddish brown, fine to medium-grained SANDSTONE				
8					TRENCH TERMINATED AT 9 FEET				

**Figure A-4,**  
**Log of Trench T 3, Page 1 of 1**

07516-42-02.GPJ

SAMPLE SYMBOLS		... SAMPLING UNSUCCESSFUL		... STANDARD PENETRATION TEST		... DRIVE SAMPLE (UNDISTURBED)
		... DISTURBED OR BAG SAMPLE		... CHUNK SAMPLE		... WATER TABLE OR SEEPAGE

NOTE: THE LOG OF SUBSURFACE CONDITIONS SHOWN HEREON APPLIES ONLY AT THE SPECIFIC BORING OR TRENCH LOCATION AND AT THE DATE INDICATED. IT IS NOT WARRANTED TO BE REPRESENTATIVE OF SUBSURFACE CONDITIONS AT OTHER LOCATIONS AND TIMES.



DEPTH IN FEET	SAMPLE NO.	LITHOLOGY	GROUNDWATER	SOIL CLASS (USCS)	<b>TRENCH T 4</b>		PENETRATION RESISTANCE (BLOWS/FT.)	DRY DENSITY (P.C.F.)	MOISTURE CONTENT (%)
					ELEV. (MSL.) <u>170'</u>	DATE COMPLETED <u>04-14-2005</u>			
					EQUIPMENT <u>JD 305</u> BY: <u>C. JENSEN</u>				
MATERIAL DESCRIPTION									
0				GP	<b>TOPSOIL</b> Loose to moderately dense, dry, brown, Sandy COBBLE with roots and boulders approximately 2 feet in diameter				
2			CL		Firm, humid, brown, Sandy CLAY with roots				
4				SM	<b>MISSION VALLEY FORMATION</b> Moderately dense to dense, weak to friable, humid, light reddish brown, fine to medium-grained, SANDSTONE				
6									
8									
10									
TRENCH TERMINATED AT 10 FEET									





**Figure A-5,**  
**Log of Trench T 4, Page 1 of 1**

07516-42-02.GPJ

SAMPLE SYMBOLS	... SAMPLING UNSUCCESSFUL	... STANDARD PENETRATION TEST	... DRIVE SAMPLE (UNDISTURBED)
	... DISTURBED OR BAG SAMPLE	... CHUNK SAMPLE	... WATER TABLE OR SEEPAGE







NOTE: THE LOG OF SUBSURFACE CONDITIONS SHOWN HEREON APPLIES ONLY AT THE SPECIFIC BORING OR TRENCH LOCATION AND AT THE DATE INDICATED. IT IS NOT WARRANTED TO BE REPRESENTATIVE OF SUBSURFACE CONDITIONS AT OTHER LOCATIONS AND TIMES.



DEPTH IN FEET	SAMPLE NO.	LITHOLOGY	GROUNDWATER	SOIL CLASS (USCS)	<b>TRENCH T 6</b>		PENETRATION RESISTANCE (BLOWS/FT.)	DRY DENSITY (P.C.F.)	MOISTURE CONTENT (%)
					ELEV. (MSL.) <u>130'</u>	DATE COMPLETED <u>04-14-2005</u>			
					EQUIPMENT <u>JD 305</u> BY: <u>C. JENSEN</u>				
MATERIAL DESCRIPTION									
0				SM	<b>TOPSOIL</b> Loose to moderately dense, humid, light brown, Silty SAND with roots				
2				SC	<b>COLLUVIUM</b> Moderately dense to dense, damp to moist, olive brown, Clayey SAND with cobbles, with roots, cobbles up to 8" diameter				
4				SC/CL	<b>TERRACE DEPOSIT</b> Stiff, moist, reddish brown, yellow and black, Sandy CLAY with cobbles and gravel				
6				GC	Dense to very dense, humid, Sandy COBBLES with clay, angular to sub-rounded cobbles up to 1 foot diameter				
TRENCH TERMINATED AT 7 FEET									

**Figure A-7,**  
**Log of Trench T 6, Page 1 of 1**

07516-42-02.GPJ







SAMPLE SYMBOLS		... SAMPLING UNSUCCESSFUL		... STANDARD PENETRATION TEST		... DRIVE SAMPLE (UNDISTURBED)
		... DISTURBED OR BAG SAMPLE		... CHUNK SAMPLE		... WATER TABLE OR SEEPAGE

NOTE: THE LOG OF SUBSURFACE CONDITIONS SHOWN HEREON APPLIES ONLY AT THE SPECIFIC BORING OR TRENCH LOCATION AND AT THE DATE INDICATED. IT IS NOT WARRANTED TO BE REPRESENTATIVE OF SUBSURFACE CONDITIONS AT OTHER LOCATIONS AND TIMES.

DEPTH IN FEET	SAMPLE NO.	LITHOLOGY	GROUNDWATER	SOIL CLASS (USCS)	<b>TRENCH T 7</b>		PENETRATION RESISTANCE (BLOWS/FT.)	DRY DENSITY (P.C.F.)	MOISTURE CONTENT (%)
					ELEV. (MSL.) <u>125'</u>	DATE COMPLETED <u>04-14-2005</u>			
					EQUIPMENT <u>JD 305</u> BY: <u>C. JENSEN</u>				
MATERIAL DESCRIPTION									
0				SM	<b>TOPSOIL</b> Loose to moderately dense, humid, brown, Silty, fine-grained SAND with roots				
2				SC	<b>TERRACE DEPOSIT</b> Moderately dense to dense, damp, brown, Clayey, fine-grained SAND with gravel and cobbles				
4									
6	T7-1			CL	Firm to stiff, moist, mottled reddish brown and gray, Sandy CLAY with gravel and cobbles				
8									
10	T7-2			CL	Stiff, moist, gray with reddish brown, Silty CLAY with cobbles up to 6" diameter				
12									
TRENCH TERMINATED AT 13 FEET									

**Figure A-8,**  
**Log of Trench T 7, Page 1 of 1**

07516-42-02.GPJ

SAMPLE SYMBOLS	 ... SAMPLING UNSUCCESSFUL	 ... STANDARD PENETRATION TEST	 ... DRIVE SAMPLE (UNDISTURBED)
	 ... DISTURBED OR BAG SAMPLE	 ... CHUNK SAMPLE	 ... WATER TABLE OR SEEPAGE

NOTE: THE LOG OF SUBSURFACE CONDITIONS SHOWN HEREON APPLIES ONLY AT THE SPECIFIC BORING OR TRENCH LOCATION AND AT THE DATE INDICATED. IT IS NOT WARRANTED TO BE REPRESENTATIVE OF SUBSURFACE CONDITIONS AT OTHER LOCATIONS AND TIMES.



DEPTH IN FEET	SAMPLE NO.	LITHOLOGY	GROUNDWATER	SOIL CLASS (USCS)	<b>TRENCH T 8</b>		PENETRATION RESISTANCE (BLOWS/FT.)	DRY DENSITY (P.C.F.)	MOISTURE CONTENT (%)
					ELEV. (MSL.) <u>115'</u>	DATE COMPLETED <u>04-14-2005</u>			
					EQUIPMENT <u>JD 305</u> BY: <u>C. JENSEN</u>				
MATERIAL DESCRIPTION									
0	T8-1			SM	<b>TOPSOIL</b> Loose to moderately dense, humid, brown, Silty, fine-grained SAND with roots charcoal and organics				
2				SM	Moderately dense, humid, light reddish brown, Silty SAND with roots				
4				SC	<b>TERRACE DEPOSIT</b> Moderately dense to dense, damp, dark grayish brown, Clayey SAND with trace lenses of light reddish brown silty sand				
				SC	Very dense, humid, dark brown, Clayey SAND				
TRENCH TERMINATED AT 5.5 FEET									

**Figure A-9,**  
**Log of Trench T 8, Page 1 of 1**

07516-42-02.GPJ







<b>SAMPLE SYMBOLS</b>	... SAMPLING UNSUCCESSFUL	... STANDARD PENETRATION TEST	... DRIVE SAMPLE (UNDISTURBED)
	... DISTURBED OR BAG SAMPLE	... CHUNK SAMPLE	... WATER TABLE OR SEEPAGE

NOTE: THE LOG OF SUBSURFACE CONDITIONS SHOWN HEREON APPLIES ONLY AT THE SPECIFIC BORING OR TRENCH LOCATION AND AT THE DATE INDICATED. IT IS NOT WARRANTED TO BE REPRESENTATIVE OF SUBSURFACE CONDITIONS AT OTHER LOCATIONS AND TIMES.



DEPTH IN FEET	SAMPLE NO.	LITHOLOGY	GROUNDWATER	SOIL CLASS (USCS)	<b>TRENCH T 9</b>		PENETRATION RESISTANCE (BLOWS/FT.)	DRY DENSITY (P.C.F.)	MOISTURE CONTENT (%)
					ELEV. (MSL.) <u>110'</u>	DATE COMPLETED <u>04-14-2005</u>			
					EQUIPMENT <u>JD 305</u> BY: <u>C. JENSEN</u>				
MATERIAL DESCRIPTION									
0				CL	<b>TOPSOIL</b> Firm, humid, dark brown, Sandy CLAY with roots and gravel				
2	T9-1			CL	<b>TERRACE DEPOSIT</b> Very stiff, humid, dark brown, Silty CLAY with cobbles, with interbedded gravel and cobble lenses		121.2	11.9	
TRENCH TERMINATED AT 3.5 FEET									

**Figure A-10,**  
**Log of Trench T 9, Page 1 of 1**

07516-42-02.GPJ







SAMPLE SYMBOLS	 ... SAMPLING UNSUCCESSFUL	 ... STANDARD PENETRATION TEST	 ... DRIVE SAMPLE (UNDISTURBED)
	 ... DISTURBED OR BAG SAMPLE	 ... CHUNK SAMPLE	 ... WATER TABLE OR SEEPAGE

NOTE: THE LOG OF SUBSURFACE CONDITIONS SHOWN HEREON APPLIES ONLY AT THE SPECIFIC BORING OR TRENCH LOCATION AND AT THE DATE INDICATED. IT IS NOT WARRANTED TO BE REPRESENTATIVE OF SUBSURFACE CONDITIONS AT OTHER LOCATIONS AND TIMES.

DEPTH IN FEET	SAMPLE NO.	LITHOLOGY	GROUNDWATER	SOIL CLASS (USCS)	<b>TRENCH T 10</b>		PENETRATION RESISTANCE (BLOWS/FT.)	DRY DENSITY (P.C.F.)	MOISTURE CONTENT (%)
					ELEV. (MSL.) <u>105'</u>	DATE COMPLETED <u>04-14-2005</u>			
					EQUIPMENT <u>JD 305</u>		BY: <u>C. JENSEN</u>		
MATERIAL DESCRIPTION									
0				SC	<b>TOPSOIL</b> Loose to moderately dense, dry, light brown, Clayey SAND with roots				
2						<b>TERRACE DEPOSIT</b> Dense, humid to damp, dark brown, Clayey SAND			
4				SC					
6									
8									
10									
12				SP	Very dense, damp, dark brown, Cobbly fine-grained SAND with subangular to subrounded gravel and cobbles up to 1 foot diameter				
14					SM	Dense, moist, dark reddish brown, Gravelly, fine to medium-grained SAND with trace cobbles			
TRENCH TERMINATED AT 15 FEET									

**Figure A-11,**  
**Log of Trench T 10, Page 1 of 1**

07516-42-02.GPJ







SAMPLE SYMBOLS		... SAMPLING UNSUCCESSFUL		... STANDARD PENETRATION TEST		... DRIVE SAMPLE (UNDISTURBED)
		... DISTURBED OR BAG SAMPLE		... CHUNK SAMPLE		... WATER TABLE OR SEEPAGE

NOTE: THE LOG OF SUBSURFACE CONDITIONS SHOWN HEREON APPLIES ONLY AT THE SPECIFIC BORING OR TRENCH LOCATION AND AT THE DATE INDICATED. IT IS NOT WARRANTED TO BE REPRESENTATIVE OF SUBSURFACE CONDITIONS AT OTHER LOCATIONS AND TIMES.

DEPTH IN FEET	SAMPLE NO.	LITHOLOGY	GROUNDWATER	SOIL CLASS (USCS)	<b>TRENCH T 11</b>		PENETRATION RESISTANCE (BLOWS/FT.)	DRY DENSITY (P.C.F.)	MOISTURE CONTENT (%)
					ELEV. (MSL.) <u>100'</u>	DATE COMPLETED <u>04-14-2005</u>			
					EQUIPMENT <u>JD 305</u> BY: <u>C. JENSEN</u>				
MATERIAL DESCRIPTION									
0				SC	<b>ARTIFICIAL FILL</b> Moderately dense, damp, brown, Clayey SAND with roots				
2				GC	<b>TERRACE DEPOSITS</b> Dense to stiff, moist, reddish brown, Cobbly Sandy CLAY with gravel and cobbles up to 1 foot diameter				
4									
6									
TRENCH TERMINATED AT 7 FEET									

**Figure A-12,**  
**Log of Trench T 11, Page 1 of 1**

07516-42-02.GPJ

SAMPLE SYMBOLS	 ... SAMPLING UNSUCCESSFUL	 ... STANDARD PENETRATION TEST	 ... DRIVE SAMPLE (UNDISTURBED)
	 ... DISTURBED OR BAG SAMPLE	 ... CHUNK SAMPLE	 ... WATER TABLE OR SEEPAGE

NOTE: THE LOG OF SUBSURFACE CONDITIONS SHOWN HEREON APPLIES ONLY AT THE SPECIFIC BORING OR TRENCH LOCATION AND AT THE DATE INDICATED. IT IS NOT WARRANTED TO BE REPRESENTATIVE OF SUBSURFACE CONDITIONS AT OTHER LOCATIONS AND TIMES.





DEPTH IN FEET	SAMPLE NO.	LITHOLOGY	GROUNDWATER	SOIL CLASS (USCS)	TRENCH T 12		PENETRATION RESISTANCE (BLOWS/FT.)	DRY DENSITY (P.C.F.)	MOISTURE CONTENT (%)
					ELEV. (MSL.) <u>100'</u>	DATE COMPLETED <u>04-14-2005</u>			
					EQUIPMENT <u>JD 305</u> BY: <u>C. JENSEN</u>				
					MATERIAL DESCRIPTION				
0	T12-1			SM	<b>ARTIFICIAL FILL</b> Very loose to loose, dry, light brown to white, Silty, fine-grained SAND with roots, with plastic				
2				SM	Loose to moderately dense, humid, light reddish brown, Silty, fine-grained SAND with roots				
4				SM	Moderately dense, humid, light brown, Silty, fine-grained SAND with roots				
6				GP-GM	Moderately dense to dense, humid, dark brown, Sandy COBBLES with asphalt debris				
8				SM	Moderately dense, humid, olive, Silty, fine-grained SAND with plastic and cobbles				
10				SM	Moderately dense, moist, greenish gray, Silty, fine-grained SAND with plastic pipe with cobbles up to 1.5 feet in diameter				
12				SM					
14									
16									
18					TRENCH TERMINATED AT 18 FEET				

**Figure A-13,**  
**Log of Trench T 12, Page 1 of 1**

07516-42-02.GPJ







SAMPLE SYMBOLS		... SAMPLING UNSUCCESSFUL		... STANDARD PENETRATION TEST		... DRIVE SAMPLE (UNDISTURBED)
		... DISTURBED OR BAG SAMPLE		... CHUNK SAMPLE		... WATER TABLE OR SEEPAGE

NOTE: THE LOG OF SUBSURFACE CONDITIONS SHOWN HEREON APPLIES ONLY AT THE SPECIFIC BORING OR TRENCH LOCATION AND AT THE DATE INDICATED. IT IS NOT WARRANTED TO BE REPRESENTATIVE OF SUBSURFACE CONDITIONS AT OTHER LOCATIONS AND TIMES.

DEPTH IN FEET	SAMPLE NO.	LITHOLOGY	GROUNDWATER	SOIL CLASS (USCS)	<b>TRENCH T 13</b>		PENETRATION RESISTANCE (BLOWS/FT.)	DRY DENSITY (P.C.F.)	MOISTURE CONTENT (%)
					ELEV. (MSL.) <u>105'</u>	DATE COMPLETED <u>04-15-2005</u>			
					EQUIPMENT <u>JD 305</u> BY: <u>C. JENSEN</u>				
MATERIAL DESCRIPTION									
0				SM	<b>TOPSOIL</b> Moderately dense, dry to damp, brown, Silty, fine-grained SAND with roots				
2				SC	<b>TERRACE DEPOSIT</b> Moderately dense, moist, dark brown, Clayey, fine-grained SAND with carbonate				
4					Stiff to very stiff, moist, dark brown, Sandy CLAY				
6				CL					
8									
10									
12									
14				SP	Dense to very dense, damp, brown, Gravelly, fine to medium grained SAND with subrounded to subangular gravel and cobbles up to 4" diameter				
TRENCH TERMINATED AT 14 FEET									

**Figure A-14,**  
**Log of Trench T 13, Page 1 of 1**

07516-42-02.GPJ

SAMPLE SYMBOLS	 ... SAMPLING UNSUCCESSFUL	 ... STANDARD PENETRATION TEST	 ... DRIVE SAMPLE (UNDISTURBED)
	 ... DISTURBED OR BAG SAMPLE	 ... CHUNK SAMPLE	 ... WATER TABLE OR SEEPAGE

NOTE: THE LOG OF SUBSURFACE CONDITIONS SHOWN HEREON APPLIES ONLY AT THE SPECIFIC BORING OR TRENCH LOCATION AND AT THE DATE INDICATED. IT IS NOT WARRANTED TO BE REPRESENTATIVE OF SUBSURFACE CONDITIONS AT OTHER LOCATIONS AND TIMES.





DEPTH IN FEET	SAMPLE NO.	LITHOLOGY	GROUNDWATER	SOIL CLASS (USCS)	<b>TRENCH T 14</b>		PENETRATION RESISTANCE (BLOWS/FT.)	DRY DENSITY (P.C.F.)	MOISTURE CONTENT (%)
					ELEV. (MSL.) <u>105'</u>	DATE COMPLETED <u>04-15-2005</u>			
					EQUIPMENT <u>JD 305</u> BY: <u>C. JENSEN</u>				
					MATERIAL DESCRIPTION				
0	T14-1			SM	<b>TOPSOIL</b> Moderately dense, dry to damp, brown, Silty, fine-grained SAND with roots				
2			SC	<b>TERRACE DEPOSIT</b> Moderately dense, moist, dark brown, Clayey, fine-grained SAND with carbonate					
4			SC	Dense, moist, dark brown, Clayey, fine-grained SAND with trace gravel					
6			SP	Dense to very dense, damp, brown, Gravelly, fine to medium-grained SAND with cobbles up to 6" diameter, cobbles and gravel subrounded					
8					TRENCH TERMINATED AT 10 FEET				
10									

**Figure A-15,**  
**Log of Trench T 14, Page 1 of 1**

07516-42-02.GPJ





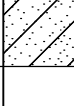

<b>SAMPLE SYMBOLS</b>	... SAMPLING UNSUCCESSFUL	... STANDARD PENETRATION TEST	... DRIVE SAMPLE (UNDISTURBED)
	... DISTURBED OR BAG SAMPLE	... CHUNK SAMPLE	... WATER TABLE OR SEEPAGE

NOTE: THE LOG OF SUBSURFACE CONDITIONS SHOWN HEREON APPLIES ONLY AT THE SPECIFIC BORING OR TRENCH LOCATION AND AT THE DATE INDICATED. IT IS NOT WARRANTED TO BE REPRESENTATIVE OF SUBSURFACE CONDITIONS AT OTHER LOCATIONS AND TIMES.



DEPTH IN FEET	SAMPLE NO.	LITHOLOGY	GROUNDWATER	SOIL CLASS (USCS)	<b>TRENCH T 15</b>		PENETRATION RESISTANCE (BLOWS/FT.)	DRY DENSITY (P.C.F.)	MOISTURE CONTENT (%)
					ELEV. (MSL.) <u>110'</u>	DATE COMPLETED <u>04-15-2005</u>			
					EQUIPMENT <u>JD 305</u> BY: <u>C. JENSEN</u>				
MATERIAL DESCRIPTION									
0				SM	<b>TOPSOIL</b> Loose to moderately dense, dry to humid, light brown, Silty, fine-grained SAND with roots				
2				SC	<b>TERRACE DEPOSIT</b> Moderately dense, damp to moist, reddish brown, Clayey, fine-grained SAND with micas				
4				SC	Moderately dense to dense, moist, Clayey, fine-grained SAND				
6				SC					
8				CL	Firm to stiff, damp, mottled reddish brown and dark brown, Sandy CLAY				
10					TRENCH TERMINATED AT 10 FEET				

**Figure A-16,**  
**Log of Trench T 15, Page 1 of 1**

07516-42-02.GPJ







SAMPLE SYMBOLS	 ... SAMPLING UNSUCCESSFUL	 ... STANDARD PENETRATION TEST	 ... DRIVE SAMPLE (UNDISTURBED)
	 ... DISTURBED OR BAG SAMPLE	 ... CHUNK SAMPLE	 ... WATER TABLE OR SEEPAGE

NOTE: THE LOG OF SUBSURFACE CONDITIONS SHOWN HEREON APPLIES ONLY AT THE SPECIFIC BORING OR TRENCH LOCATION AND AT THE DATE INDICATED. IT IS NOT WARRANTED TO BE REPRESENTATIVE OF SUBSURFACE CONDITIONS AT OTHER LOCATIONS AND TIMES.

DEPTH IN FEET	SAMPLE NO.	LITHOLOGY	GROUNDWATER	SOIL CLASS (USCS)	<b>TRENCH T 16</b>		PENETRATION RESISTANCE (BLOWS/FT.)	DRY DENSITY (P.C.F.)	MOISTURE CONTENT (%)
					ELEV. (MSL.) <u>115'</u>	DATE COMPLETED <u>04-15-2005</u>			
					EQUIPMENT <u>JD 305</u>		BY: <u>C. JENSEN</u>		
MATERIAL DESCRIPTION									
0				SM	<b>TOPSOIL</b> Loose to moderately dense, dry to damp, light brown, Silty, fine- grained SAND with roots				
2				SM	<b>TERRACE DEPOSIT</b> Moderately dense, damp, light reddish brown, Silty, fine-grained SAND with carbonate				
4						Moderately dense to dense, moist, dark brown, Clayey, fine-grained SAND			
6				SC					
8									
10						TRENCH TERMINATED AT 10 FEET			

**Figure A-17,**  
**Log of Trench T 16, Page 1 of 1**

07516-42-02.GPJ







SAMPLE SYMBOLS		... SAMPLING UNSUCCESSFUL		... STANDARD PENETRATION TEST		... DRIVE SAMPLE (UNDISTURBED)
		... DISTURBED OR BAG SAMPLE		... CHUNK SAMPLE		... WATER TABLE OR SEEPAGE

NOTE: THE LOG OF SUBSURFACE CONDITIONS SHOWN HEREON APPLIES ONLY AT THE SPECIFIC BORING OR TRENCH LOCATION AND AT THE DATE INDICATED. IT IS NOT WARRANTED TO BE REPRESENTATIVE OF SUBSURFACE CONDITIONS AT OTHER LOCATIONS AND TIMES.



DEPTH IN FEET	SAMPLE NO.	LITHOLOGY	GROUNDWATER	SOIL CLASS (USCS)	<b>TRENCH T 17</b>		PENETRATION RESISTANCE (BLOWS/FT.)	DRY DENSITY (P.C.F.)	MOISTURE CONTENT (%)
					ELEV. (MSL.) <u>105'</u>	DATE COMPLETED <u>04-15-2005</u>			
					EQUIPMENT <u>JD 305</u> BY: <u>C. JENSEN</u>				
MATERIAL DESCRIPTION									
0				SM	<b>TOPSOIL</b> Loose to moderately dense, dry, light brown, Silty, fine-grained SAND with roots				
2				SC	<b>TERRACE DEPOSIT</b> Moderately dense, moist, light reddish brown, Clayey, fine-grained SAND with carbonate				
4	T17-1			SC	Moderately dense to dense, moist, dark brown, Clayey, fine-grained SAND with granitic floater boulders		99.4	18.0	
6									
8				CL	Dense, moist, mottled reddish brown and dark brown Sandy CLAY				
TRENCH TERMINATED AT 8 FEET									

**Figure A-18,**  
**Log of Trench T 17, Page 1 of 1**

07516-42-02.GPJ



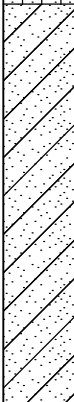



SAMPLE SYMBOLS	 ... SAMPLING UNSUCCESSFUL	 ... STANDARD PENETRATION TEST	 ... DRIVE SAMPLE (UNDISTURBED)
	 ... DISTURBED OR BAG SAMPLE	 ... CHUNK SAMPLE	 ... WATER TABLE OR SEEPAGE

NOTE: THE LOG OF SUBSURFACE CONDITIONS SHOWN HEREON APPLIES ONLY AT THE SPECIFIC BORING OR TRENCH LOCATION AND AT THE DATE INDICATED. IT IS NOT WARRANTED TO BE REPRESENTATIVE OF SUBSURFACE CONDITIONS AT OTHER LOCATIONS AND TIMES.

DEPTH IN FEET	SAMPLE NO.	LITHOLOGY	GROUNDWATER	SOIL CLASS (USCS)	<b>TRENCH T 18</b>		PENETRATION RESISTANCE (BLOWS/FT.)	DRY DENSITY (P.C.F.)	MOISTURE CONTENT (%)
					ELEV. (MSL.) <u>110'</u>	DATE COMPLETED <u>04-15-2005</u>			
					EQUIPMENT <u>JD 305</u>		BY: <u>C. JENSEN</u>		
MATERIAL DESCRIPTION									
0				SM	<b>TOPSOIL</b> Loose to moderately dense, dry to humid, light brown, Silty SAND with roots				
2				CL	<b>TERRACE DEPOSIT</b> Firm to stiff, damp to moist, dark brown with white specs, Sandy CLAY with carbonate				
4									
6									
8									
10									
12				SP	Dense to very dense, damp, reddish brown, Gravelly, fine to coarse grained SAND, with subrounded gravel and cobbles up to 6" diameter				
TRENCH TERMINATED AT 12 FEET									

**Figure A-19,**  
**Log of Trench T 18, Page 1 of 1**

07516-42-02.GPJ

SAMPLE SYMBOLS	 ... SAMPLING UNSUCCESSFUL	 ... STANDARD PENETRATION TEST	 ... DRIVE SAMPLE (UNDISTURBED)
	 ... DISTURBED OR BAG SAMPLE	 ... CHUNK SAMPLE	 ... WATER TABLE OR SEEPAGE

NOTE: THE LOG OF SUBSURFACE CONDITIONS SHOWN HEREON APPLIES ONLY AT THE SPECIFIC BORING OR TRENCH LOCATION AND AT THE DATE INDICATED. IT IS NOT WARRANTED TO BE REPRESENTATIVE OF SUBSURFACE CONDITIONS AT OTHER LOCATIONS AND TIMES.

DEPTH IN FEET	SAMPLE NO.	LITHOLOGY	GROUNDWATER	SOIL CLASS (USCS)	<b>TRENCH T 19</b>		PENETRATION RESISTANCE (BLOWS/FT.)	DRY DENSITY (P.C.F.)	MOISTURE CONTENT (%)
					ELEV. (MSL.) <u>105'</u>	DATE COMPLETED <u>04-15-2005</u>			
					EQUIPMENT <u>JD 305</u>		BY: <u>C. JENSEN</u>		
MATERIAL DESCRIPTION									
0	T19-1			SM	<b>TOPSOIL</b> Loose to moderately dense, dry to humid, light brown, Silty SAND with roots				
2				CL	<b>TERRACE DEPOSIT</b> Firm to stiff, damp to moist, dark brown with white specs, Sandy CLAY with abundant carbonate			104.0	13.8
4					Dense, damp, reddish brown, Clayey, fine-grained SAND				
6				SC					
8									
10				SP	Dense to very dense, damp, reddish brown, GRAVELLY, medium-to coarse-grained SAND with subrounded gravels and cobbles up to 4" diameter				
TRENCH TERMINATED AT 10 FEET									



**Figure A-20,**  
**Log of Trench T 19, Page 1 of 1**

07516-42-02.GPJ

SAMPLE SYMBOLS		... SAMPLING UNSUCCESSFUL		... STANDARD PENETRATION TEST		... DRIVE SAMPLE (UNDISTURBED)
		... DISTURBED OR BAG SAMPLE		... CHUNK SAMPLE		... WATER TABLE OR SEEPAGE







NOTE: THE LOG OF SUBSURFACE CONDITIONS SHOWN HEREON APPLIES ONLY AT THE SPECIFIC BORING OR TRENCH LOCATION AND AT THE DATE INDICATED. IT IS NOT WARRANTED TO BE REPRESENTATIVE OF SUBSURFACE CONDITIONS AT OTHER LOCATIONS AND TIMES.



DEPTH IN FEET	SAMPLE NO.	LITHOLOGY	GROUNDWATER	SOIL CLASS (USCS)	<b>TRENCH T 20</b>		PENETRATION RESISTANCE (BLOWS/FT.)	DRY DENSITY (P.C.F.)	MOISTURE CONTENT (%)
					ELEV. (MSL.) <u>100'</u>	DATE COMPLETED <u>04-15-2005</u>			
					EQUIPMENT <u>JD 305</u>		BY: <u>C. JENSEN</u>		
MATERIAL DESCRIPTION									
0				SM	<b>ARTIFICIAL FILL</b> Loose to moderately dense, dry to humid, light brown, Silty, fine-grained SAND with plastic debris and roots				
2				CL	<b>ALLUVIUM</b> Stiff, damp, dark brown, Sandy CLAY with trace gravel				
4				GP	<b>TERRACE DEPOSIT</b> Dense, damp, dark reddish brown, Clayey Sandy COBBLES with subrounded gravel and cobbles				
6					TRENCH TERMINATED AT 6 FEET				

**Figure A-21,**  
**Log of Trench T 20, Page 1 of 1**

07516-42-02.GPJ

SAMPLE SYMBOLS	 ... SAMPLING UNSUCCESSFUL	 ... STANDARD PENETRATION TEST	 ... DRIVE SAMPLE (UNDISTURBED)
	 ... DISTURBED OR BAG SAMPLE	 ... CHUNK SAMPLE	 ... WATER TABLE OR SEEPAGE

NOTE: THE LOG OF SUBSURFACE CONDITIONS SHOWN HEREON APPLIES ONLY AT THE SPECIFIC BORING OR TRENCH LOCATION AND AT THE DATE INDICATED. IT IS NOT WARRANTED TO BE REPRESENTATIVE OF SUBSURFACE CONDITIONS AT OTHER LOCATIONS AND TIMES.

DEPTH IN FEET	SAMPLE NO.	LITHOLOGY	GROUNDWATER	SOIL CLASS (USCS)	<b>TRENCH T 21</b>		PENETRATION RESISTANCE (BLOWS/FT.)	DRY DENSITY (P.C.F.)	MOISTURE CONTENT (%)
					ELEV. (MSL.) <u>100'</u>	DATE COMPLETED <u>04-15-2005</u>			
					EQUIPMENT <u>JD 305</u> BY: <u>C. JENSEN</u>				
MATERIAL DESCRIPTION									
0				SM	<b>ARTIFICIAL FILL</b> Very loose to loose, damp, light reddish brown, Silty SAND with gravel with roots				
2				SC	Loose to moderately dense, moist, mottled dark brown and olive, Clayey SAND				
4				SP	<b>TERRACE DEPOSIT</b> Moderately dense to very dense, moist, reddish brown, Gravelly, medium to coarse-grained SAND with subrounded gravel and cobbles up to 1 foot diameter				
6					TRENCH TERMINATED AT 7 FEET				

**Figure A-22,**  
**Log of Trench T 21, Page 1 of 1**

07516-42-02.GPJ

SAMPLE SYMBOLS		... SAMPLING UNSUCCESSFUL		... STANDARD PENETRATION TEST		... DRIVE SAMPLE (UNDISTURBED)
		... DISTURBED OR BAG SAMPLE		... CHUNK SAMPLE		... WATER TABLE OR SEEPAGE

NOTE: THE LOG OF SUBSURFACE CONDITIONS SHOWN HEREON APPLIES ONLY AT THE SPECIFIC BORING OR TRENCH LOCATION AND AT THE DATE INDICATED. IT IS NOT WARRANTED TO BE REPRESENTATIVE OF SUBSURFACE CONDITIONS AT OTHER LOCATIONS AND TIMES.





DEPTH IN FEET	SAMPLE NO.	LITHOLOGY	GROUNDWATER	SOIL CLASS (USCS)	<b>TRENCH T 22</b>		PENETRATION RESISTANCE (BLOWS/FT.)	DRY DENSITY (P.C.F.)	MOISTURE CONTENT (%)	
					ELEV. (MSL.) <u>100'</u>	DATE COMPLETED <u>04-15-2005</u>				
					EQUIPMENT <u>JD 305</u>		BY: <u>C. JENSEN</u>			
MATERIAL DESCRIPTION										
0				SM	<b>ARTIFICIAL FILL</b> Loose, dry to damp, brown, Silty SAND with debris greater than 2 feet diameter asphalt concrete curb, brick, plastic and wood					
2										
4										
6										
8				CL	<b>TOPSOIL</b> Firm, moist, black, Sandy CLAY with gravel					
				SP	<b>TERRACE DEPOSIT</b> Dense, moist, reddish brown, Gravelly Cobbly SAND with subrounded gravel and cobbles to 1 foot diameter					
10					TRENCH TERMINATED AT 10 FEET					

**Figure A-23,**  
**Log of Trench T 22, Page 1 of 1**

07516-42-02.GPJ







SAMPLE SYMBOLS		... SAMPLING UNSUCCESSFUL		... STANDARD PENETRATION TEST		... DRIVE SAMPLE (UNDISTURBED)
		... DISTURBED OR BAG SAMPLE		... CHUNK SAMPLE		... WATER TABLE OR SEEPAGE

NOTE: THE LOG OF SUBSURFACE CONDITIONS SHOWN HEREON APPLIES ONLY AT THE SPECIFIC BORING OR TRENCH LOCATION AND AT THE DATE INDICATED. IT IS NOT WARRANTED TO BE REPRESENTATIVE OF SUBSURFACE CONDITIONS AT OTHER LOCATIONS AND TIMES.

DEPTH IN FEET	SAMPLE NO.	LITHOLOGY	GROUNDWATER	SOIL CLASS (USCS)	<b>TRENCH T 23</b>		PENETRATION RESISTANCE (BLOWS/FT.)	DRY DENSITY (P.C.F.)	MOISTURE CONTENT (%)
					ELEV. (MSL.) <u>100'</u>	DATE COMPLETED <u>04-15-2005</u>			
					EQUIPMENT <u>JD 305</u> BY: <u>C. JENSEN</u>				
MATERIAL DESCRIPTION									
0				CL	<b>ARTIFICIAL FILL</b> Firm, moist, light brown to brown, Sandy CLAY with rock fragments				
2				SC	<b>TOPSOIL</b> Moderately dense, moist, dark brown, Clayey SAND				
4				SC	<b>TERRACE DEPOSIT</b> Moderately dense, reddish brown, Clayey SAND with cobbles and boulders up to 1.5 foot diameter				
6				SM	Dense, damp to moist, reddish brown, Silty, fine to medium grained SAND with cobbles				
TRENCH TERMINATED AT 6 FEET									

**Figure A-24,**  
**Log of Trench T 23, Page 1 of 1**

07516-42-02.GPJ

SAMPLE SYMBOLS		... SAMPLING UNSUCCESSFUL		... STANDARD PENETRATION TEST		... DRIVE SAMPLE (UNDISTURBED)
		... DISTURBED OR BAG SAMPLE		... CHUNK SAMPLE		... WATER TABLE OR SEEPAGE

NOTE: THE LOG OF SUBSURFACE CONDITIONS SHOWN HEREON APPLIES ONLY AT THE SPECIFIC BORING OR TRENCH LOCATION AND AT THE DATE INDICATED. IT IS NOT WARRANTED TO BE REPRESENTATIVE OF SUBSURFACE CONDITIONS AT OTHER LOCATIONS AND TIMES.

APPENDIX

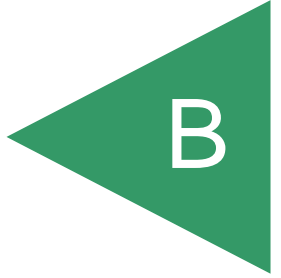

## APPENDIX B

### LABORATORY TESTING

Laboratory tests were performed in accordance with generally accepted test methods of the American Society for Testing and Materials (ASTM) or other suggested procedures. Selected samples were tested for expansion potential, maximum dry density and optimum moisture content, shear strength characteristics and sulfate content. The results of these tests are summarized on Tables B-I through B-IV.

**TABLE B-I  
SUMMARY OF LABORATORY EXPANSION INDEX TEST RESULTS  
ASTM D 4829-03**

Sample No.	Moisture Content (%)		Dry Density (pcf)	Expansion Index
	Before Test	After Test		
T1-2	10.4	21.4	108.7	51
T3-2	12.1	23.3	101.9	31
T7-1	10.7	22.5	106.4	49
T12-1	12.8	21.1	100.4	1

**TABLE B-II  
SUMMARY OF LABORATORY MAXIMUM DRY DENSITY  
AND OPTIMUM MOISTURE CONTENT TEST RESULTS  
ASTM D 1557-02**

Sample No.	Description	Maximum Dry Density (pcf)	Optimum Moisture Content (% dry wt.)
T1-2	Light brown, Clayey GRAVEL with little fine to course Sand	132.6	8.2
T3-2	Light yellowish brown fine Sandy SILT with little Clay	120.5	11.9

**TABLE B-III  
SUMMARY OF DIRECT SHEAR TEST RESULTS  
ASTM D 3080-03**

Sample No.	Dry Density (pcf)	Moisture Content (%)	Unit Cohesion (psf) [ultimate]	Angle of Shear Resistance [ultimate] (degrees)
*T1-2	117.8	9.2	400	18
*T3-2	108.5	11.6	200	36
LD1-2	101.0	14.1	28 [31]	740 [500]
LD1-5	103.1	13.2	29 [28]	900 [870]

\* Samples remolded to 90 percent relative density near optimum moisture content.

**TABLE B-IV  
SUMMARY OF LABORATORY WATER-SOLUBLE SULFATE TEST RESULTS  
CALIFORNIA TEST NO. 417**

<b>Sample No.</b>	<b>Water-Soluble Sulfate(%)</b>	<b>Sulfate Class</b>
T1-2	0.088	S0
T3-2	0.026	S0
T7-1	0.054	S0
T12-1	0.008	S0

SAMPLE NO.: 1-2 GEOLOGIC UNIT: Tmv  
 SAMPLE DEPTH (FT): 20' NATURAL/REMOLDED: N

INITIAL CONDITIONS				
NORMAL STRESS TEST LOAD	1 K	2 K	4 K	AVERAGE
ACTUAL NORMAL STRESS (PSF):	890	2030	4300	--
WATER CONTENT (%):	14.5	13.5	14.3	14.1
DRY DENSITY (PCF):	103.2	98.0	101.6	101.0

AFTER TEST CONDITIONS				
NORMAL STRESS TEST LOAD	1 K	2 K	4 K	AVERAGE
WATER CONTENT (%):	22.3	25.1	23.9	23.8
PEAK SHEAR STRESS (PSF):	1310	1750	3050	--
ULT.-E.O.T. SHEAR STRESS (PSF):	983	1760	3101	--

RESULTS		
PEAK	COHESION, C (PSF)	740
	FRICTION ANGLE (DEGREES)	28
ULTIMATE	COHESION, C (PSF)	500
	FRICTION ANGLE (DEGREES)	31

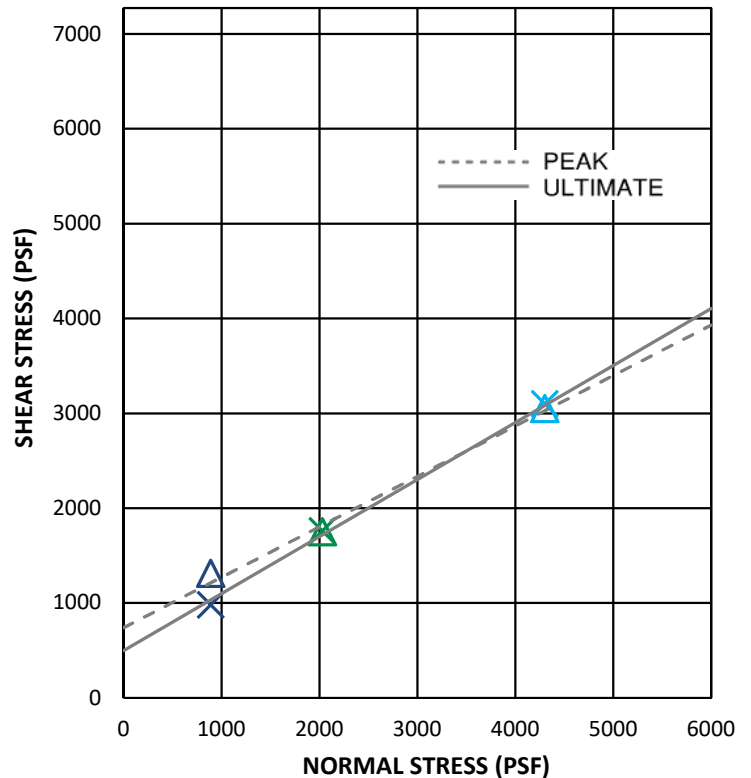
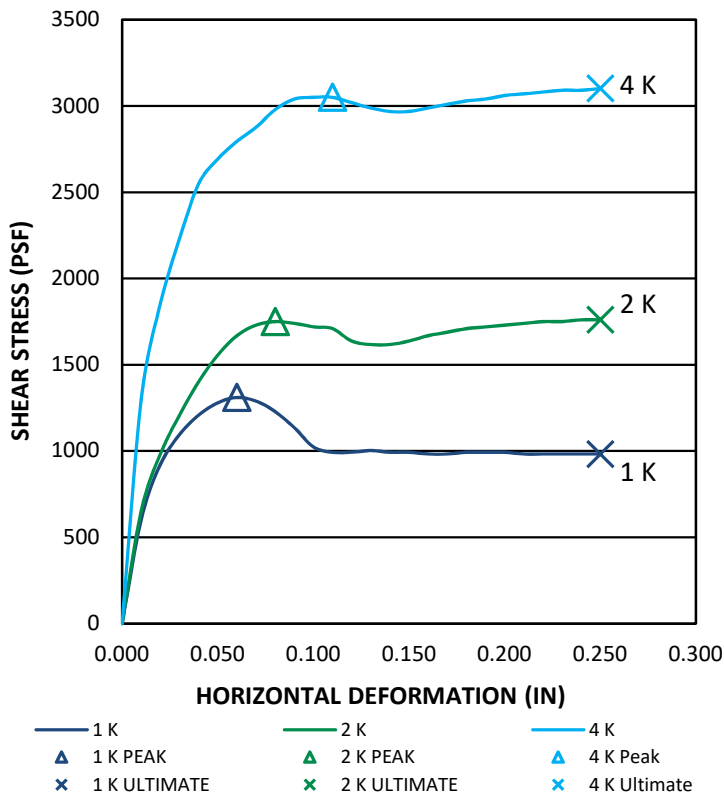

**DIRECT SHEAR - ASTM D 3080**

**GEOCON**  
INCORPORATED



GEOTECHNICAL CONSULTANTS  
 6960 FLANDERS DRIVE - SAN DIEGO, CALIFORNIA 92121-2974  
 PHONE 858 558-6900 - FAX 858 558-6159

**NAKANO PROPERTY**

**PROJECT NO.: 7516-42-02**



SAMPLE NO.: 1-5 GEOLOGIC UNIT: Tmv  
 SAMPLE DEPTH (FT): 50' NATURAL/REMOLDED: N

INITIAL CONDITIONS				
NORMAL STRESS TEST LOAD	1 K	2 K	4 K	AVERAGE
ACTUAL NORMAL STRESS (PSF):	890	2030	4300	--
WATER CONTENT (%):	13.0	13.7	12.7	13.2
DRY DENSITY (PCF):	102.8	101.5	104.9	103.1

AFTER TEST CONDITIONS				
NORMAL STRESS TEST LOAD	1 K	2 K	4 K	AVERAGE
WATER CONTENT (%):	22.3	23.6	22.0	22.7
PEAK SHEAR STRESS (PSF):	1341	2159	3234	--
ULT.-E.O.T. SHEAR STRESS (PSF):	1177	2200	3070	--

RESULTS		
PEAK	COHESION, C (PSF)	900
	FRICTION ANGLE (DEGREES)	29
ULTIMATE	COHESION, C (PSF)	870
	FRICTION ANGLE (DEGREES)	28

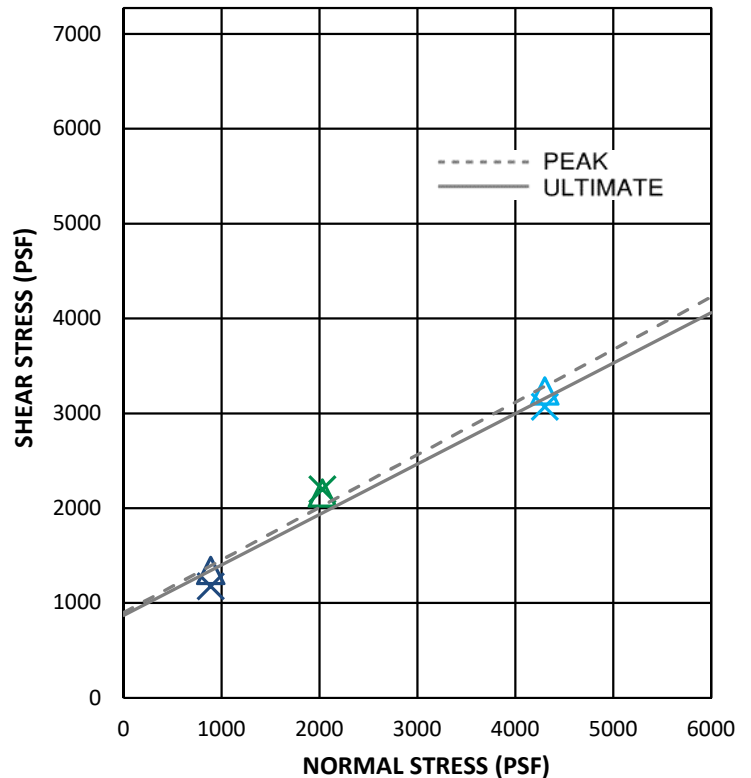
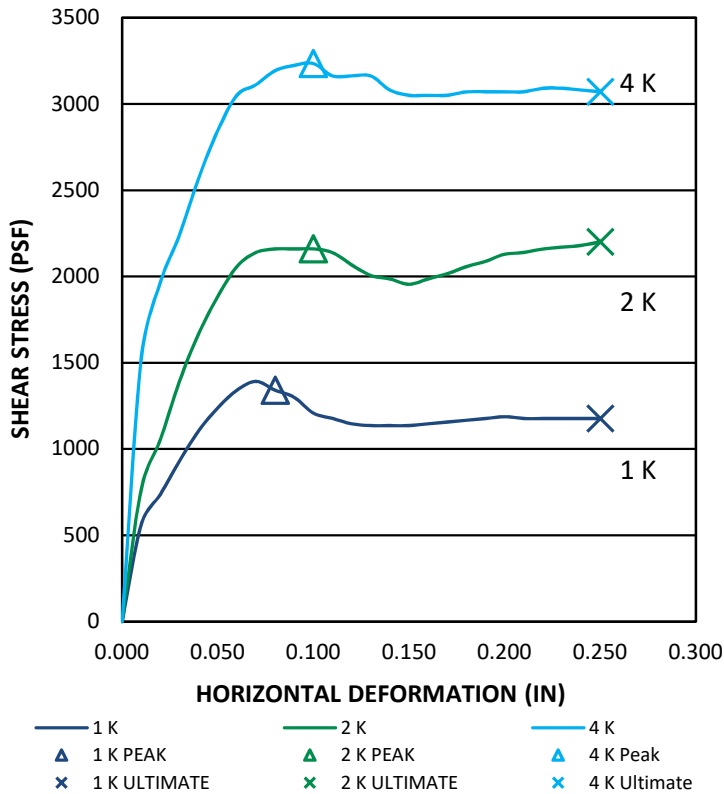

**DIRECT SHEAR - ASTM D 3080**

**GEOCON**  
INCORPORATED



GEOTECHNICAL CONSULTANTS  
 6960 FLANDERS DRIVE - SAN DIEGO, CALIFORNIA 92121-2974  
 PHONE 858 558-6900 - FAX 858 558-6159

**NAKANO PROPERTY**

**PROJECT NO.: 7516-42-02**

APPENDIX

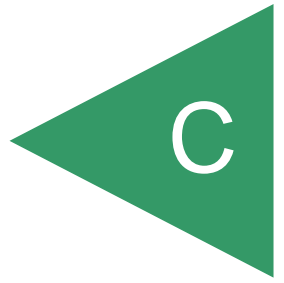

## APPENDIX C

### STORM WATER MANAGEMENT

We understand storm water management devices are being proposed in accordance with the current Storm Water Standards (SWS). If not properly constructed, there is a potential for distress to improvements and properties located hydrologically down gradient or adjacent to these devices. Factors such as the amount of water to be detained, its residence time, and soil permeability have an important effect on seepage transmission and the potential adverse impacts that may occur if the storm water management features are not properly designed and constructed. We have not performed a hydrogeological study at the site. If infiltration of storm water runoff occurs, downstream properties and improvements may be subjected to seeps, springs, slope instability, raised groundwater, movement of foundations and slabs, or other undesirable impacts as a result of water infiltration.

#### Hydrologic Soil Group

The United States Department of Agriculture (USDA), Natural Resources Conservation Services, possesses general information regarding the existing soil conditions for areas within the United States. The USDA website also provides the Hydrologic Soil Group. Table C-1 presents the descriptions of the hydrologic soil groups. In addition, the USDA website also provides an estimated saturated hydraulic conductivity for the existing soil.

**TABLE C-1  
HYDROLOGIC SOIL GROUP DEFINITIONS**

Soil Group	Soil Group Definition
A	Soils having a high infiltration rate (low runoff potential) when thoroughly wet. These consist mainly of deep, well drained to excessively drained sands or gravelly sands. These soils have a high rate of water transmission.
B	Soils having a moderate infiltration rate when thoroughly wet. These consist chiefly of moderately deep or deep, moderately well drained or well drained soils that have moderately fine texture to moderately coarse texture. These soils have a moderate rate of water transmission.
C	Soils having a slow infiltration rate when thoroughly wet. These consist chiefly of soils having a layer that impedes the downward movement of water or soils of moderately fine texture or fine texture. These soils have a slow rate of water transmission.
D	Soils having a very slow infiltration rate (high runoff potential) when thoroughly wet. These consist chiefly of clays that have a high shrink-swell potential, soils that have a high water table, soils that have a claypan or clay layer at or near the surface, and soils that are shallow over nearly impervious material. These soils have a very slow rate of water transmission.

The property is underlain by undocumented fill, surficial deposits such as topsoil, colluvium and alluvium, Terrace Deposits, and the Mission Valley Formation. Table C-2 presents the information from the USDA website for the subject property.

**TABLE C-2  
USDA WEB SOIL SURVEY – HYDROLOGIC SOIL GROUP**

Map Unit Name	Map Unit Symbol	Approximate Percentage of Property	Hydrologic Soil Group
Olivenhain cobbly loam, 9 to 30 percent slopes	OhE	5.0	D
Riverwash	Rm	18.5	D
Salinas clay loam, 0 to 2 percent slopes, warm MAAT, MLRA 19	SbA	76.6	C

### Infiltration Testing

We performed two borehole infiltration tests at the locations shown on Figure 2. The tests were performed in 8-inch-diameter, drilled borings. Table C-3 presents the results of the testing. The calculation sheets are provided herein.

We used the guidelines presented in the Riverside County Low Impact Development BMP Design Handbook. Based on this widely accepted guideline, the saturated hydraulic conductivity (Ksat) is equivalent to the infiltration rate. Therefore, the Ksat value determined from our testing is assumed to be the unfactored infiltration rate.

**TABLE C-3  
UNFACTORED, FIELD-SATURATED, INFILTRATION TEST RESULTS**

Test No.	Depth (inches)	Geologic Unit	Field Infiltration Rate, I (in/hr)	Factored* Field Infiltration Rate, I (in/hr)
A-1	68	Qudf	0.004	0.002
A-2	92	Qudf	0.244	0.12

\* Factor of Safety of 2.0 for feasibility determination.

## STORM WATER MANAGEMENT CONCLUSIONS

### Soil Types

**Undocumented Fill (Qpudf)** – We encountered undocumented fill up to 18 feet thick at the north end of the property. The undocumented fill within structural improvement areas will be removed and replaced with compacted fill. Water that is allowed to migrate into the undocumented fill or

compacted fill will cause settlement. Therefore, full and partial infiltration should be considered infeasible within fill.

**Topsoil (Unmapped)** – We encountered topsoil varying between 0.5 and 3 feet thick across the site. Topsoil within structural improvement areas will be removed and replaced with compacted fill. Water that is allowed to migrate into the topsoil will cause settlement. Therefore, full and partial infiltration should be considered infeasible within topsoil.

**Colluvium (Qcol)** – We encountered colluvium on the north-facing slopes at the south property boundary, varying between 0.5 and 5 feet thick. Colluvium within structural improvement areas will be removed and replaced with compacted fill. Water that is allowed to migrate into colluvium will cause settlement. Therefore, full and partial infiltration should be considered infeasible within areas underlain by colluvium.

**Alluvium (Qal)** – Alluvium is present in a drainage located at the southeast corner of the property. Alluvium was also encountered in Trench T-20 beneath undocumented fill at the north end of the site. Alluvium within structural improvement areas will be removed and replaced with compacted fill. Water that is allowed to migrate into alluvium will cause settlement. Therefore, full and partial infiltration should be considered infeasible within areas underlain by alluvium.

**Terrace Deposits (Qt)** – We encountered Terrace Deposits underlying most of the site below the artificial fill, topsoil, and alluvium. Infiltration into Terrace Deposits may be possible.

**Mission Valley Formation (Tmv)** – We encountered age Mission Valley in slopes along the southern portion of the site. Mission Valley Formation may also be present underlying the Terrace Deposits in the central portion of the site. Infiltration into the Mission Valley Formation is not feasible due to low infiltration characteristics.

## Groundwater Elevation

Groundwater was not encountered in our borings or trenches to a depths explored. Infiltration should not impact groundwater.

## Existing Utilities

Existing utilities are located on the north side of the property and along the west and east property margins. Infiltration near these utilities is considered infeasible. Otherwise, infiltration due to utility concerns would be feasible.

## Soil or Groundwater Contamination

We are unaware of contaminated soil or groundwater on the property. Therefore, full and partial infiltration associated with this risk is considered feasible.

## Slopes

There are no existing slopes that would be impacted by infiltration. There are proposed fill slopes where infiltration adjacent to the slopes is not feasible.

## Infiltration Rates

Our test results indicated slow infiltration rates. The factored rates were 0.002 and 0.12 inches per hour. The infiltration rates are not high enough to support full or partial infiltration in the area of the proposed BMP.

## Storm Water Management Devices

Liners should be incorporated in the proposed basin. The liner should be impermeable (e.g. High-density polyethylene, HDPE, with a thickness of about 30 mil or equivalent Polyvinyl Chloride, PVC). Penetration of the liners should be properly sealed. The devices should also be installed in accordance with the manufacturer's recommendations. Overflow protection devices should also be incorporated into the design and construction of the storm water management device.

## Storm Water Standard Worksheets

The SWS requests the geotechnical engineer complete the *Categorization of Infiltration Feasibility Condition* (Worksheet C.4-1) worksheet information to help evaluate the potential for infiltration on the property. The attached Worksheet C.4-1 presents the completed information for the submittal process.

The regional storm water standards also have a worksheet (Worksheet Form D.5-1) that helps the project civil engineer estimate the factor of safety based on several factors. Table C-4 describes the suitability assessment input parameters related to the geotechnical engineering aspects for the factor of safety determination.

**TABLE C-4**  
**SUITABILITY ASSESSMENT RELATED CONSIDERATIONS FOR INFILTRATION FACILITY**  
**SAFETY FACTORS**

Consideration	High Concern – 3 Points	Medium Concern – 2 Points	Low Concern – 1 Point
Assessment Methods	Use of soil survey maps or simple texture analysis to estimate short-term infiltration rates. Use of well permeameter or borehole methods without accompanying continuous boring log. Relatively sparse testing with direct infiltration methods	Use of well permeameter or borehole methods with accompanying continuous boring log. Direct measurement of infiltration area with localized infiltration measurement methods (e.g., Infiltrometer). Moderate spatial resolution	Direct measurement with localized (i.e. small-scale) infiltration testing methods at relatively high resolution or use of extensive test pit infiltration measurement methods.
Predominant Soil Texture	Silty and clayey soils with significant fines	Loamy soils	Granular to slightly loamy soils
Site Soil Variability	Highly variable soils indicated from site assessment or unknown variability	Soil boring/test pits indicate moderately homogenous soils	Soil boring/test pits indicate relatively homogenous soils
Depth to Groundwater/ Impervious Layer	<5 feet below facility bottom	5-15 feet below facility bottom	>15 feet below facility bottom

Table C-5 presents the estimated factor values for the evaluation of the factor of safety. This table only presents the suitability assessment safety factor (Part A) of the worksheet. The project civil engineer should evaluate the safety factor for design (Part B) and use the combined safety factor for the design infiltration rate.

**TABLE C-5**  
**FACTOR OF SAFETY WORKSHEET D.5-1 DESIGN VALUES<sup>1</sup>**

Suitability Assessment Factor Category	Assigned Weight (w)	Factor Value (v)	Product (p = w x v)
Assessment Methods	0.25	2	0.50
Predominant Soil Texture	0.25	3	0.75
Site Soil Variability	0.25	2	0.50
Depth to Groundwater/Impervious Layer	0.25	1	0.25
Suitability Assessment Safety Factor, $S_A = \Sigma p$			2.0

<sup>1</sup> The project civil engineer should complete Worksheet D.5-1 using the data on this table. Additional information is required to evaluate the design factor of safety.

## CONCLUSIONS

Our results indicate the site has relatively slow infiltration characteristics. Because of the site conditions, it is our opinion that there is a potential for lateral water migration. Undocumented and previously placed fill exists on the property and has a high potential for adverse settlement when wetted. It is our opinion that full or partial infiltration is infeasible on this site. Our evaluation included the soil and geologic conditions, estimated settlement and volume change of the underlying soil, slope stability, utility considerations, groundwater mounding, retaining walls, foundations and existing groundwater elevations.





### Aardvark Permeameter Data Analysis

Project Name: Nakano  
 Project Number: 07516-42-02  
 Test Number: A-1

Date: 12/20/2019  
 By: BRK

Borehole Diameter, d (in.): 8.00  
 Borehole Depth, H (in.): 68.00  
 Distance Between Reservoir & Top of Borehole (in.): 26.00  
 Height APM Raised from Bottom (in.): 2.00  
 Pressure Reducer Used: No

Ref. EL (feet, MSL): 102.0  
 Bottom EL (feet, MSL): 96.3

Distance Between Reservoir and APM Float, D (in.): 84.75  
 Head Height Measured, h (in.): 5.50

Reading	Time Elapsed (min)	Water Weight Consummed (lbs)	Water Volume Consummed (in <sup>3</sup> )	Q (in <sup>3</sup> /min)
1	0.00	0.000	0.00	0.00
2	5.00	11.530	319.29	63.858
3	5.00	1.665	46.11	9.222
4	5.00	0.155	4.29	0.858
5	5.00	0.045	1.25	0.249
6	5.00	0.045	1.25	0.249
7	5.00	0.035	0.97	0.194
8	5.00	0.035	0.97	0.194
9	10.00	0.045	1.25	0.125
10	10.00	0.045	1.25	0.125
11	10.00	0.030	0.83	0.083
12	10.00	0.025	0.69	0.069
13	10.00	0.020	0.55	0.055
14	10.00	0.015	0.42	0.042
15	10.00	0.015	0.42	0.042

Steady Flow Rate, Q (in<sup>3</sup>/min): 0.046

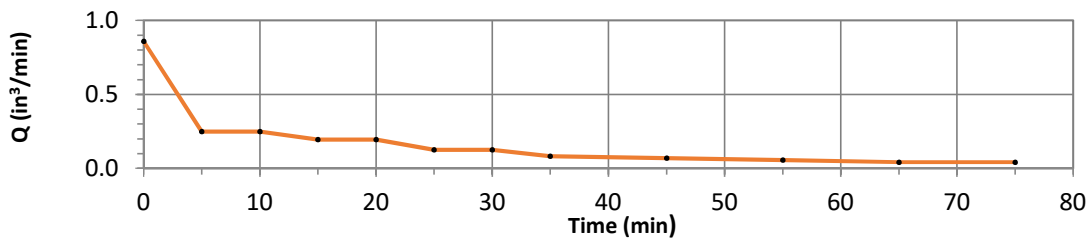

#### Soil Matric Flux Potential, $\phi_m$

$\phi_m =$  0.00060 in<sup>2</sup>/min

#### Field-Saturated Hydraulic Conductivity (Infiltration Rate)

$K_{sat} =$  6.07E-05 in/min      0.004 in/hr



**Borehole Infiltration Test**

Project Name: Nakano  
 Project Number: 07516-42-02  
 Test Number: A-2

Date: 12/20/2019  
 By: BRK  
 Ref. EL (feet, MSL): 100.0  
 Bottom EL (feet, MSL): 92.3

Borehole Diameter, d (in.): 8.00  
 Borehole Depth, H (in.): 92.00  
 Distance Between Reservoir & Top of Borehole (in.): 26.00  
 Height APM Raised from Bottom (in.): 2.00  
 Pressure Reducer Used: No

Distance Between Reservoir and APM Float, D (in.): 108.75  
 Head Height Measured, h (in.): 4.75

Reading	Time Elapsed (min)	Water Weight Consummed (lbs)	Water Volume Consummed (in <sup>3</sup> )	Q (in <sup>3</sup> /min)
1	0.00	0.000	0.00	0.00
2	5.00	11.255	311.68	62.335
3	5.00	1.095	30.32	6.065
4	5.00	0.315	8.72	1.745
5	5.00	0.995	27.55	5.511
6	5.00	1.075	29.77	5.954
7	5.00	0.985	27.28	5.455
8	5.00	0.915	25.34	5.068
9	5.00	0.890	24.65	4.929
10	5.00	0.845	23.40	4.680
11	5.00	0.770	21.32	4.265
12	5.00	0.740	20.49	4.098
13	5.00	0.695	19.25	3.849
14	5.00	0.665	18.42	3.683
15	5.00	0.655	18.14	3.628
16	6.00	0.750	20.77	3.462
17	4.00	0.440	12.18	3.046
18	5.00	0.565	15.65	3.129
19	5.00	0.535	14.82	2.963
20	5.00	0.530	14.68	2.935
21	5.00	0.510	14.12	2.825
22	6.00	0.610	16.89	2.815
23	4.00	0.405	11.22	2.804
Steady Flow Rate, Q (in <sup>3</sup> /min):				2.815

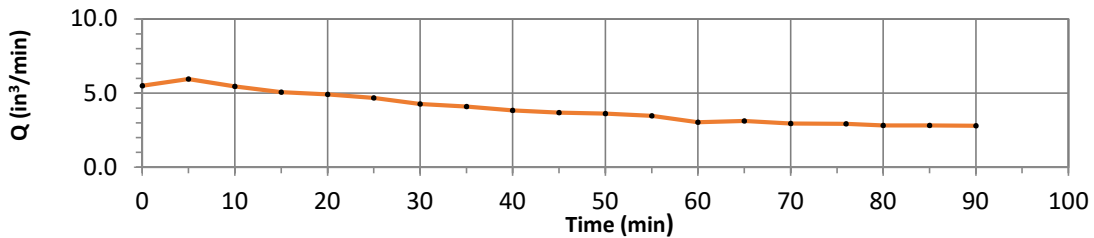

**Soil Matric Flux Potential,  $\phi_m$**

$\phi_m =$  0.0538 in<sup>2</sup>/min

**Field-Saturated Hydraulic Conductivity (Infiltration Rate)**

$K_{sat} =$  1.37E-03 in/min      0.082 in/hr

Project Name: \_\_\_\_\_

Categorization of Infiltration Feasibility Condition based on Geotechnical Conditions		Form I-8A <sup>1</sup> (Worksheet C.4-1)
<b>Part 1 - Full Infiltration Feasibility Screening Criteria</b>		
<b>DMA(s) Being Analyzed:</b>		<b>Project Phase:</b>
Entire Site		Planning
<b>Criteria 1: Infiltration Rate Screening</b>		
<b>1A</b>	<p>Is the mapped hydrologic soil group according to the NRCS Web Soil Survey or UC Davis Soil Web Mapper Type A or B and corroborated by available site soil data<sup>2</sup>?</p> <p><input type="checkbox"/> Yes; the DMA may feasibly support full infiltration. Answer “Yes” to Criteria 1 Result or continue to Step 1B if the applicant elects to perform infiltration testing.</p> <p><input type="checkbox"/> No; the mapped soil types are A or B but is not corroborated by available site soil data (continue to Step 1B).</p> <p><input checked="" type="checkbox"/> No; the mapped soil types are C, D, or “urban/unclassified” and is corroborated by available site soil data. Answer “No” to Criteria 1 Result.</p> <p><input type="checkbox"/> No; the mapped soil types are C, D, or “urban/unclassified” but is not corroborated by available site soil data (continue to Step 1B).</p>	
<b>1B</b>	<p>Is the reliable infiltration rate calculated using planning phase methods from Table D.3-1?</p> <p><input checked="" type="checkbox"/> Yes; Continue to Step 1C.</p> <p><input type="checkbox"/> No; Skip to Step 1D.</p>	
<b>1C</b>	<p>Is the reliable infiltration rate calculated using planning phase methods from Table D.3-1 greater than 0.5 inches per hour?</p> <p><input type="checkbox"/> Yes; the DMA may feasibly support full infiltration. Answer “Yes” to Criteria 1 Result.</p> <p><input checked="" type="checkbox"/> No; full infiltration is not required. Answer “No” to Criteria 1 Result.</p>	
<b>1D</b>	<p><b>Infiltration Testing Method.</b> Is the selected infiltration testing method suitable during the design phase (see Appendix D.3)? Note: Alternative testing standards may be allowed with appropriate rationales and documentation.</p> <p><input type="checkbox"/> Yes; continue to Step 1E.</p> <p><input type="checkbox"/> No; select an appropriate infiltration testing method.</p>	
<b>1E</b>	<p><b>Number of Percolation/Infiltration Tests.</b> Does the infiltration testing method performed satisfy the minimum number of tests specified in Table D.3-2?</p> <p><input type="checkbox"/> Yes; continue to Step 1F.</p> <p><input type="checkbox"/> No; conduct appropriate number of tests.</p>	

<sup>1</sup> This form must be completed each time there is a change to the site layout that would affect the infiltration feasibility condition. Previously completed forms shall be retained to document the evolution of the site storm water design.

<sup>2</sup> Available data includes site-specific sampling or observation of soil types or texture classes, such as obtained from borings or test pits necessary to support other design elements.



Project Name: \_\_\_\_\_

Categorization of Infiltration Feasibility Condition based on Geotechnical Conditions		Form I-8A <sup>1</sup> (Worksheet C.4-1)
<b>IF</b>	<p><b>Factor of Safety.</b> Is the suitable Factor of Safety selected for full infiltration design? See guidance in D.5; Tables D.5-1 and D.5-2; and Worksheet D.5-1 (Form I-9).</p> <p><input type="checkbox"/> Yes; continue to Step 1G.  <input type="checkbox"/> No; select appropriate factor of safety.</p>	
<b>1G</b>	<p><b>Full Infiltration Feasibility.</b> Is the average measured infiltration rate divided by the Factor of Safety greater than 0.5 inches per hour?</p> <p><input type="checkbox"/> Yes; answer “Yes” to Criteria 1 Result.  <input type="checkbox"/> No; answer “No” to Criteria 1 Result.</p>	
<b>Criteria 1 Result</b>	<p>Is the estimated reliable infiltration rate greater than 0.5 inches per hour within the DMA where runoff can reasonably be routed to a BMP?</p> <p><input type="checkbox"/> Yes; the DMA may feasibly support full infiltration. Continue to Criteria 2.  <input checked="" type="checkbox"/> No; full infiltration is not required. Skip to Part 1 Result.</p>	
<p>Summarize infiltration testing methods, testing locations, replicates, and results and summarize estimates of reliable infiltration rates according to procedures outlined in D.5. Documentation should be included in project geotechnical report.</p> <p><b>Infiltration was performed at two locations within the project site using borehole infiltration tests. The test results were as follows:</b></p> <p>A-1: 0.004 in/hr (0.002 in/hr using a factor of safety of 2.0 for feasibility determination)  A-2: 0.082 in/hr (0.041 in/hr using a factor of safety of 2.0 for feasibility determination)</p> <p><b>Infiltration test information is contained in the geotechnical investigation dated September 18, 2020.</b></p>		
<b>Criteria 2: Geologic/Geotechnical Screening</b>		
<b>2A</b>	<p><b>If all questions in Step 2A are answered “Yes,” continue to Step 2B.</b></p> <p>For any “No” answer in Step 2A answer “No” to Criteria 2 and submit an “Infiltration Feasibility Condition Letter” that meets the requirements in Appendix C.1.1.</p> <p>The geologic/geotechnical analyses listed in Appendix C.2.1 do not apply to the DMA because one of the following setbacks cannot be avoided and therefore result in the DMA being in a no infiltration condition. The setbacks must be the closest horizontal radial distance from the surface edge (at the overflow elevation) of the BMP.</p>	

Project Name: \_\_\_\_\_

Categorization of Infiltration Feasibility Condition based on Geotechnical Conditions		Form I-8A <sup>1</sup> (Worksheet C.4-1)	
2A-1	Can the proposed full infiltration BMP(s) avoid areas with existing fill materials greater than 5 feet thick below the infiltrating surface?	<input type="checkbox"/> Yes	<input type="checkbox"/> No
2A-2	Can the proposed full infiltration BMP(s) avoid placement within 10 feet of existing underground utilities, structures, or retaining walls?	<input type="checkbox"/> Yes	<input type="checkbox"/> No
2A-3	Can the proposed full infiltration BMP(s) avoid placement within 50 feet of a natural slope (>25%) or within a distance of 1.5H from fill slopes where H is the height of the fill slope?	<input type="checkbox"/> Yes	<input type="checkbox"/> No
<b>2B</b>	When full infiltration is determined to be feasible, a geotechnical investigation report must be prepared that considers the relevant factors identified in Appendix C.2.1. If all questions in Step 2B are answered “Yes,” then answer “Yes” to Criteria 2 Result. If there are “No” answers continue to Step 2C.		
2B-1	<b>Hydroconsolidation.</b> Analyze hydroconsolidation potential per approved ASTM standard due to a proposed full infiltration BMP. Can full infiltration BMPs be proposed within the DMA without increasing hydroconsolidation risks?	<input type="checkbox"/> Yes	<input type="checkbox"/> No
2B-2	<b>Expansive Soils.</b> Identify expansive soils (soils with an expansion index greater than 20) and the extent of such soils due to proposed full infiltration BMPs. Can full infiltration BMPs be proposed within the DMA without increasing expansive soil risks?	<input type="checkbox"/> Yes	<input type="checkbox"/> No
2B-3	<b>Liquefaction.</b> If applicable, identify mapped liquefaction areas. Evaluate liquefaction hazards in accordance with Section 6.4.2 of the City of San Diego's Guidelines for Geotechnical Reports (2011 or most recent edition). Liquefaction hazard assessment shall take into account any increase in groundwater elevation or groundwater mounding that could occur as a result of proposed infiltration or percolation facilities. Can full infiltration BMPs be proposed within the DMA without increasing liquefaction risks?	<input type="checkbox"/> Yes	<input type="checkbox"/> No
2B-4	<b>Slope Stability.</b> If applicable, perform a slope stability analysis in accordance with the ASCE and Southern California Earthquake Center (2002) Recommended Procedures for Implementation of DMG Special Publication 117, Guidelines for Analyzing and Mitigating Landslide Hazards in California to determine minimum slope setbacks for full infiltration BMPs. See the City of San Diego's Guidelines for Geotechnical Reports (2011) to determine which type of slope stability analysis is required. Can full infiltration BMPs be proposed within the DMA without increasing slope stability risks?	<input type="checkbox"/> Yes	<input type="checkbox"/> No
2B-5	<b>Other Geotechnical Hazards.</b> Identify site-specific geotechnical hazards not already mentioned (refer to Appendix C.2.1). Can full infiltration BMPs be proposed within the DMA without increasing risk of geologic or geotechnical hazards not already mentioned?	<input type="checkbox"/> Yes	<input type="checkbox"/> No

Project Name: \_\_\_\_\_

Categorization of Infiltration Feasibility Condition based on Geotechnical Conditions		Form I-8A <sup>1</sup> (Worksheet C.4-1)	
2B-6	<p><b>Setbacks.</b> Establish setbacks from underground utilities, structures, and/or retaining walls. Reference applicable ASTM or other recognized standard in the geotechnical report.</p> <p>Can full infiltration BMPs be proposed within the DMA using established setbacks from underground utilities, structures, and/or retaining walls?</p>	<input type="checkbox"/> Yes	<input type="checkbox"/> No
2C	<p><b>Mitigation Measures.</b> Propose mitigation measures for each geologic/geotechnical hazard identified in Step 2B. Provide a discussion of geologic/geotechnical hazards that would prevent full infiltration BMPs that cannot be reasonably mitigated in the geotechnical report. See Appendix C.2.1.8 for a list of typically reasonable and typically unreasonable mitigation measures.</p> <p>Can mitigation measures be proposed to allow for full infiltration BMPs? If the question in Step 2 is answered “Yes,” then answer “Yes” to Criteria 2 Result.</p> <p>If the question in Step 2C is answered “No,” then answer “No” to Criteria 2 Result.</p>	<input type="checkbox"/> Yes	<input type="checkbox"/> No
<b>Criteria 2 Result</b>	Can infiltration greater than 0.5 inches per hour be allowed without increasing risk of geologic or geotechnical hazards that cannot be reasonably mitigated to an acceptable level?	<input type="checkbox"/> Yes	<input type="checkbox"/> No
Summarize findings and basis; provide references to related reports or exhibits.			
<b>Part 1 Result – Full Infiltration Geotechnical Screening</b> <sup>3</sup>		<b>Result</b>	
<p>If answers to both Criteria 1 and Criteria 2 are “Yes”, a full infiltration design is potentially feasible based on Geotechnical conditions only.</p> <p>If either answer to Criteria 1 or Criteria 2 is “No”, a full infiltration design is not required.</p>		<input type="checkbox"/> <b>Full infiltration Condition</b> <input checked="" type="checkbox"/> <b>Complete Part 2</b>	

<sup>3</sup> To be completed using gathered site information and best professional judgement considering the definition of MEP in the MS4 Permit. Additional testing and/or studies may be required by City Engineer to substantiate findings.



Project Name: \_\_\_\_\_

Categorization of Infiltration Feasibility Condition based on Geotechnical Conditions		Form I-8A <sup>1</sup> (Worksheet C.4-1)
<b>Part 2 – Partial vs. No Infiltration Feasibility Screening Criteria</b>		
<b>DMA(s) Being Analyzed:</b>		<b>Project Phase:</b>
Entire Site		Planning
<b>Criteria 3 : Infiltration Rate Screening</b>		
<b>3A</b>	<p><b>NRCS Type C, D, or “urban/unclassified”:</b> Is the mapped hydrologic soil group according to the NRCS Web Soil Survey or UC Davis Soil Web Mapper is Type C, D, or “urban/unclassified” and corroborated by available site soil data?</p> <p><input type="checkbox"/> Yes; the site is mapped as C soils and a reliable infiltration rate of 0.15 in/hr. is used to size partial infiltration BMPS. Answer “Yes” to Criteria 3 Result.</p> <p><input type="checkbox"/> Yes; the site is mapped as D soils or “urban/unclassified” and a reliable infiltration rate of 0.05 in/hr. is used to size partial infiltration BMPS. Answer “Yes” to Criteria 3 Result.</p> <p><input checked="" type="checkbox"/> No; infiltration testing is conducted (refer to Table D.3-1), continue to Step 3B.</p>	
<b>3B</b>	<p><b>Infiltration Testing Result:</b> Is the reliable infiltration rate (i.e. average measured infiltration rate/2) greater than 0.05 in/hr. and less than or equal to 0.5 in/hr?</p> <p><input type="checkbox"/> Yes; the site may support partial infiltration. Answer “Yes” to Criteria 3 Result.</p> <p><input checked="" type="checkbox"/> No; the reliable infiltration rate (i.e. average measured rate/2) is less than 0.05 in/hr., partial infiltration is not required. Answer “No” to Criteria 3 Result.</p>	
<b>Criteria 3 Result</b>	<p>Is the estimated reliable infiltration rate (i.e., average measured infiltration rate/2) greater than or equal to 0.05 inches/hour and less than or equal to 0.5 inches/hour at any location within each DMA where runoff can reasonably be routed to a BMP?</p> <p><input type="checkbox"/> Yes; Continue to Criteria 4.</p> <p><input checked="" type="checkbox"/> No: Skip to Part 2 Result.</p>	
<p>Summarize infiltration testing and/or mapping results (i.e. soil maps and series description used for infiltration rate).</p> <p>Infiltration testing was performed in the area of the proposed storm water BMP at the northwest corner of the property. The test results were as follows:</p> <p>A-1: 0.004 in/hr (0.002 in/hr using a factor of safety of 2.0 for feasibility determination)                      A-2: 0.082 in/hr (0.041 in/hr using a factor of safety of 2.0 for feasibility determination)</p> <p>This rate is not fast enough for partial infiltration.</p> <p>Infiltration test information is contained in the geotechnical investigation dated September 18, 2020.</p>		

Categorization of Infiltration Feasibility Condition based on Geotechnical Conditions		Form I-8A <sup>1</sup> (Worksheet C.4-1)	
<b>Criteria 4: Geologic/Geotechnical Screening</b>			
<b>4A</b>	<p>If all questions in Step 4A are answered “Yes,” continue to Step 2B.</p> <p>For any “No” answer in Step 4A answer “No” to Criteria 4 Result, and submit an “Infiltration Feasibility Condition Letter” that meets the requirements in Appendix C.1.1. The geologic/geotechnical analyses listed in Appendix C.2.1 do not apply to the DMA because one of the following setbacks cannot be avoided and therefore result in the DMA being in a no infiltration condition. The setbacks must be the closest horizontal radial distance from the surface edge (at the overflow elevation) of the BMP.</p>		
4A-1	Can the proposed partial infiltration BMP(s) avoid areas with existing fill materials greater than 5 feet thick?	<input type="checkbox"/> Yes	<input type="checkbox"/> No
4A-2	Can the proposed partial infiltration BMP(s) avoid placement within 10 feet of existing underground utilities, structures, or retaining walls?	<input type="checkbox"/> Yes	<input type="checkbox"/> No
4A-3	Can the proposed partial infiltration BMP(s) avoid placement within 50 feet of a natural slope (>25%) or within a distance of 1.5H from fill slopes where H is the height of the fill slope?	<input type="checkbox"/> Yes	<input type="checkbox"/> No
<b>4B</b>	<p>When full infiltration is determined to be feasible, a geotechnical investigation report must be prepared that considers the relevant factors identified in Appendix C.2.1.</p> <p>If all questions in Step 4B are answered “Yes,” then answer “Yes” to Criteria 4 Result. If there are any “No” answers continue to Step 4C.</p>		
4B-1	<p><b>Hydroconsolidation.</b> Analyze hydroconsolidation potential per approved ASTM standard due to a proposed full infiltration BMP.</p> <p>Can partial infiltration BMPs be proposed within the DMA without increasing hydroconsolidation risks?</p>	<input type="checkbox"/> Yes	<input type="checkbox"/> No
4B-2	<p><b>Expansive Soils.</b> Identify expansive soils (soils with an expansion index greater than 20) and the extent of such soils due to proposed full infiltration BMPs.</p> <p>Can partial infiltration BMPs be proposed within the DMA without increasing expansive soil risks?</p>	<input type="checkbox"/> Yes	<input type="checkbox"/> No
4B-3	<p><b>Liquefaction.</b> If applicable, identify mapped liquefaction areas. Evaluate liquefaction hazards in accordance with Section 6.4.2 of the City of San Diego's Guidelines for Geotechnical Reports (2011). Liquefaction hazard assessment shall take into account any increase in groundwater elevation or groundwater mounding that could occur as a result of proposed infiltration or percolation facilities.</p> <p>Can partial infiltration BMPs be proposed within the DMA without increasing liquefaction risks?</p>	<input type="checkbox"/> Yes	<input type="checkbox"/> No



Project Name: \_\_\_\_\_

Categorization of Infiltration Feasibility Condition based on Geotechnical Conditions		Form I-8A <sup>1</sup> (Worksheet C.4-1)	
4B-4	<p><b>Slope Stability.</b> If applicable, perform a slope stability analysis in accordance with the ASCE and Southern California Earthquake Center (2002) Recommended Procedures for Implementation of DMG Special Publication 117, Guidelines for Analyzing and Mitigating Landslide Hazards in California to determine minimum slope setbacks for full infiltration BMPs. See the City of San Diego's Guidelines for Geotechnical Reports (2011) to determine which type of slope stability analysis is required.</p> <p>Can partial infiltration BMPs be proposed within the DMA without increasing slope stability risks?</p>	<input type="checkbox"/> Yes	<input type="checkbox"/> No
4B-5	<p><b>Other Geotechnical Hazards.</b> Identify site-specific geotechnical hazards not already mentioned (refer to Appendix C.2.1).</p> <p>Can partial infiltration BMPs be proposed within the DMA without increasing risk of geologic or geotechnical hazards not already mentioned?</p>	<input type="checkbox"/> Yes	<input type="checkbox"/> No
4B-6	<p><b>Setbacks.</b> Establish setbacks from underground utilities, structures, and/or retaining walls. Reference applicable ASTM or other recognized standard in the geotechnical report.</p> <p>Can partial infiltration BMPs be proposed within the DMA using recommended setbacks from underground utilities, structures, and/or retaining walls?</p>	<input type="checkbox"/> Yes	<input type="checkbox"/> No
4C	<p><b>Mitigation Measures.</b> Propose mitigation measures for each geologic/geotechnical hazard identified in Step 4B. Provide a discussion on geologic/geotechnical hazards that would prevent partial infiltration BMPs that cannot be reasonably mitigated in the geotechnical report. See Appendix C.2.1.8 for a list of typically reasonable and typically unreasonable mitigation measures.</p> <p>Can mitigation measures be proposed to allow for partial infiltration BMPs? If the question in Step 4C is answered "Yes," then answer "Yes" to Criteria 4 Result.</p> <p>If the question in Step 4C is answered "No," then answer "No" to Criteria 4 Result.</p>	<input type="checkbox"/> Yes	<input type="checkbox"/> No
<b>Criteria 4 Result</b>	<p>Can infiltration of greater than or equal to 0.05 inches/hour and less than or equal to 0.5 inches/hour be allowed without increasing the risk of geologic or geotechnical hazards that cannot be reasonably mitigated to an acceptable level?</p>	<input type="checkbox"/> Yes	<input type="checkbox"/> No

Project Name: \_\_\_\_\_

Categorization of Infiltration Feasibility Condition based on Geotechnical Conditions	Form I-8A <sup>1</sup> (Worksheet C.4-1)
<p>Summarize findings and basis; provide references to related reports or exhibits.</p>	
Part 2 – Partial Infiltration Geotechnical Screening Result <sup>4</sup>	Result
<p>If answers to both Criteria 3 and Criteria 4 are “Yes”, a partial infiltration design is potentially feasible based on geotechnical conditions only.</p> <p>If answers to either Criteria 3 or Criteria 4 is “No”, then infiltration of any volume is considered to be infeasible within the site.</p>	<p><input type="checkbox"/> Partial Infiltration Condition</p> <p><input checked="" type="checkbox"/> No Infiltration Condition</p>

<sup>4</sup> To be completed using gathered site information and best professional judgement considering the definition of MEP in the MS4 Permit. Additional testing and/or studies may be required by City Engineer to substantiate findings.



APPENDIX

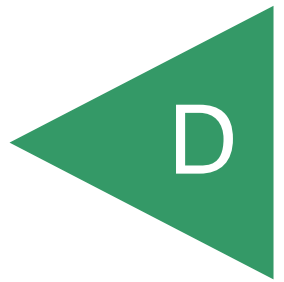

**APPENDIX D**

**RECOMMENDED GRADING SPECIFICATIONS**

**FOR**

**NAKANO PROPERTY**  
**CHULA VISTA, CALIFORNIA**

**PROJECT NO. 07516-42-02**

## RECOMMENDED GRADING SPECIFICATIONS

### 1. GENERAL

- 1.1 These Recommended Grading Specifications shall be used in conjunction with the Geotechnical Report for the project prepared by Geocon. The recommendations contained in the text of the Geotechnical Report are a part of the earthwork and grading specifications and shall supersede the provisions contained hereinafter in the case of conflict.
- 1.2 Prior to the commencement of grading, a geotechnical consultant (Consultant) shall be employed for the purpose of observing earthwork procedures and testing the fills for substantial conformance with the recommendations of the Geotechnical Report and these specifications. The Consultant should provide adequate testing and observation services so that they may assess whether, in their opinion, the work was performed in substantial conformance with these specifications. It shall be the responsibility of the Contractor to assist the Consultant and keep them apprised of work schedules and changes so that personnel may be scheduled accordingly.
- 1.3 It shall be the sole responsibility of the Contractor to provide adequate equipment and methods to accomplish the work in accordance with applicable grading codes or agency ordinances, these specifications and the approved grading plans. If, in the opinion of the Consultant, unsatisfactory conditions such as questionable soil materials, poor moisture condition, inadequate compaction, and/or adverse weather result in a quality of work not in conformance with these specifications, the Consultant will be empowered to reject the work and recommend to the Owner that grading be stopped until the unacceptable conditions are corrected.

### 2. DEFINITIONS

- 2.1 **Owner** shall refer to the owner of the property or the entity on whose behalf the grading work is being performed and who has contracted with the Contractor to have grading performed.
- 2.2 **Contractor** shall refer to the Contractor performing the site grading work.
- 2.3 **Civil Engineer** or **Engineer of Work** shall refer to the California licensed Civil Engineer or consulting firm responsible for preparation of the grading plans, surveying and verifying as-graded topography.
- 2.4 **Consultant** shall refer to the soil engineering and engineering geology consulting firm retained to provide geotechnical services for the project.

- 2.5 **Soil Engineer** shall refer to a California licensed Civil Engineer retained by the Owner, who is experienced in the practice of geotechnical engineering. The Soil Engineer shall be responsible for having qualified representatives on-site to observe and test the Contractor's work for conformance with these specifications.
- 2.6 **Engineering Geologist** shall refer to a California licensed Engineering Geologist retained by the Owner to provide geologic observations and recommendations during the site grading.
- 2.7 **Geotechnical Report** shall refer to a soil report (including all addenda) which may include a geologic reconnaissance or geologic investigation that was prepared specifically for the development of the project for which these Recommended Grading Specifications are intended to apply.

### 3. MATERIALS

- 3.1 Materials for compacted fill shall consist of any soil excavated from the cut areas or imported to the site that, in the opinion of the Consultant, is suitable for use in construction of fills. In general, fill materials can be classified as *soil* fills, *soil-rock* fills or *rock* fills, as defined below.
- 3.1.1 **Soil fills** are defined as fills containing no rocks or hard lumps greater than 12 inches in maximum dimension and containing at least 40 percent by weight of material smaller than  $\frac{3}{4}$  inch in size.
- 3.1.2 **Soil-rock fills** are defined as fills containing no rocks or hard lumps larger than 4 feet in maximum dimension and containing a sufficient matrix of soil fill to allow for proper compaction of soil fill around the rock fragments or hard lumps as specified in Paragraph 6.2. **Oversize rock** is defined as material greater than 12 inches.
- 3.1.3 **Rock fills** are defined as fills containing no rocks or hard lumps larger than 3 feet in maximum dimension and containing little or no fines. Fines are defined as material smaller than  $\frac{3}{4}$  inch in maximum dimension. The quantity of fines shall be less than approximately 20 percent of the rock fill quantity.
- 3.2 Material of a perishable, spongy, or otherwise unsuitable nature as determined by the Consultant shall not be used in fills.
- 3.3 Materials used for fill, either imported or on-site, shall not contain hazardous materials as defined by the California Code of Regulations, Title 22, Division 4, Chapter 30, Articles 9

and 10; 40CFR; and any other applicable local, state or federal laws. The Consultant shall not be responsible for the identification or analysis of the potential presence of hazardous materials. However, if observations, odors or soil discoloration cause Consultant to suspect the presence of hazardous materials, the Consultant may request from the Owner the termination of grading operations within the affected area. Prior to resuming grading operations, the Owner shall provide a written report to the Consultant indicating that the suspected materials are not hazardous as defined by applicable laws and regulations.

- 3.4 The outer 15 feet of *soil-rock* fill slopes, measured horizontally, should be composed of properly compacted *soil* fill materials approved by the Consultant. *Rock* fill may extend to the slope face, provided that the slope is not steeper than 2:1 (horizontal:vertical) and a soil layer no thicker than 12 inches is track-walked onto the face for landscaping purposes. This procedure may be utilized provided it is acceptable to the governing agency, Owner and Consultant.
- 3.5 Samples of soil materials to be used for fill should be tested in the laboratory by the Consultant to determine the maximum density, optimum moisture content, and, where appropriate, shear strength, expansion, and gradation characteristics of the soil.
- 3.6 During grading, soil or groundwater conditions other than those identified in the Geotechnical Report may be encountered by the Contractor. The Consultant shall be notified immediately to evaluate the significance of the unanticipated condition.

#### **4. CLEARING AND PREPARING AREAS TO BE FILLED**

- 4.1 Areas to be excavated and filled shall be cleared and grubbed. Clearing shall consist of complete removal above the ground surface of trees, stumps, brush, vegetation, man-made structures, and similar debris. Grubbing shall consist of removal of stumps, roots, buried logs and other unsuitable material and shall be performed in areas to be graded. Roots and other projections exceeding 1½ inches in diameter shall be removed to a depth of 3 feet below the surface of the ground. Borrow areas shall be grubbed to the extent necessary to provide suitable fill materials.
- 4.2 Asphalt pavement material removed during clearing operations should be properly disposed at an approved off-site facility or in an acceptable area of the project evaluated by Geocon and the property owner. Concrete fragments that are free of reinforcing steel may be placed in fills, provided they are placed in accordance with Section 6.2 or 6.3 of this document.

- 4.3 After clearing and grubbing of organic matter and other unsuitable material, loose or porous soils shall be removed to the depth recommended in the Geotechnical Report. The depth of removal and compaction should be observed and approved by a representative of the Consultant. The exposed surface shall then be plowed or scarified to a minimum depth of 6 inches and until the surface is free from uneven features that would tend to prevent uniform compaction by the equipment to be used.
- 4.4 Where the slope ratio of the original ground is steeper than 5:1 (horizontal:vertical), or where recommended by the Consultant, the original ground should be benched in accordance with the following illustration.

**TYPICAL BENCHING DETAIL**

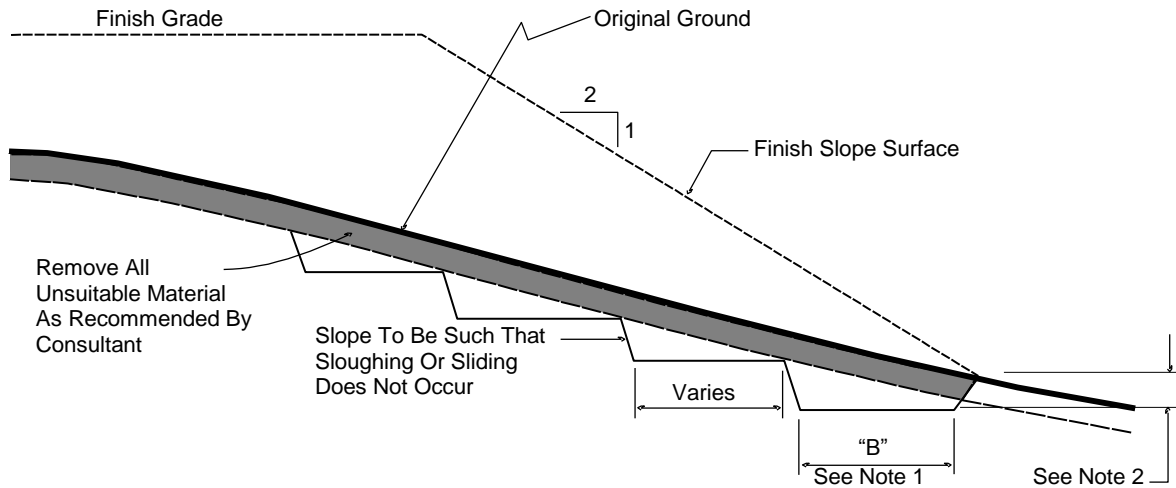

No Scale

- DETAIL NOTES: (1) Key width "B" should be a minimum of 10 feet, or sufficiently wide to permit complete coverage with the compaction equipment used. The base of the key should be graded horizontal, or inclined slightly into the natural slope.
- (2) The outside of the key should be below the topsoil or unsuitable surficial material and at least 2 feet into dense formational material. Where hard rock is exposed in the bottom of the key, the depth and configuration of the key may be modified as approved by the Consultant.

- 4.5 After areas to receive fill have been cleared and scarified, the surface should be moisture conditioned to achieve the proper moisture content, and compacted as recommended in Section 6 of these specifications.



## 5. COMPACTION EQUIPMENT

- 5.1 Compaction of *soil* or *soil-rock* fill shall be accomplished by sheepsfoot or segmented-steel wheeled rollers, vibratory rollers, multiple-wheel pneumatic-tired rollers, or other types of acceptable compaction equipment. Equipment shall be of such a design that it will be capable of compacting the *soil* or *soil-rock* fill to the specified relative compaction at the specified moisture content.
- 5.2 Compaction of *rock* fills shall be performed in accordance with Section 6.3.

## 6. PLACING, SPREADING AND COMPACTION OF FILL MATERIAL

- 6.1 *Soil* fill, as defined in Paragraph 3.1.1, shall be placed by the Contractor in accordance with the following recommendations:
- 6.1.1 *Soil* fill shall be placed by the Contractor in layers that, when compacted, should generally not exceed 8 inches. Each layer shall be spread evenly and shall be thoroughly mixed during spreading to obtain uniformity of material and moisture in each layer. The entire fill shall be constructed as a unit in nearly level lifts. Rock materials greater than 12 inches in maximum dimension shall be placed in accordance with Section 6.2 or 6.3 of these specifications.
- 6.1.2 In general, the *soil* fill shall be compacted at a moisture content at or above the optimum moisture content as determined by ASTM D 1557.
- 6.1.3 When the moisture content of *soil* fill is below that specified by the Consultant, water shall be added by the Contractor until the moisture content is in the range specified.
- 6.1.4 When the moisture content of the *soil* fill is above the range specified by the Consultant or too wet to achieve proper compaction, the *soil* fill shall be aerated by the Contractor by blading/mixing, or other satisfactory methods until the moisture content is within the range specified.
- 6.1.5 After each layer has been placed, mixed, and spread evenly, it shall be thoroughly compacted by the Contractor to a relative compaction of at least 90 percent. Relative compaction is defined as the ratio (expressed in percent) of the in-place dry density of the compacted fill to the maximum laboratory dry density as determined in accordance with ASTM D 1557. Compaction shall be continuous over the entire area, and compaction equipment shall make sufficient passes so that the specified minimum relative compaction has been achieved throughout the entire fill.

- 6.1.6 Where practical, soils having an Expansion Index greater than 50 should be placed at least 3 feet below finish pad grade and should be compacted at a moisture content generally 2 to 4 percent greater than the optimum moisture content for the material.
  - 6.1.7 Properly compacted *soil* fill shall extend to the design surface of fill slopes. To achieve proper compaction, it is recommended that fill slopes be over-built by at least 3 feet and then cut to the design grade. This procedure is considered preferable to track-walking of slopes, as described in the following paragraph.
  - 6.1.8 As an alternative to over-building of slopes, slope faces may be back-rolled with a heavy-duty loaded sheepsfoot or vibratory roller at maximum 4-foot fill height intervals. Upon completion, slopes should then be track-walked with a D-8 dozer or similar equipment, such that a dozer track covers all slope surfaces at least twice.
- 6.2 *Soil-rock* fill, as defined in Paragraph 3.1.2, shall be placed by the Contractor in accordance with the following recommendations:
- 6.2.1 Rocks larger than 12 inches but less than 4 feet in maximum dimension may be incorporated into the compacted *soil* fill, but shall be limited to the area measured 15 feet minimum horizontally from the slope face and 5 feet below finish grade or 3 feet below the deepest utility, whichever is deeper.
  - 6.2.2 Rocks or rock fragments up to 4 feet in maximum dimension may either be individually placed or placed in windrows. Under certain conditions, rocks or rock fragments up to 10 feet in maximum dimension may be placed using similar methods. The acceptability of placing rock materials greater than 4 feet in maximum dimension shall be evaluated during grading as specific cases arise and shall be approved by the Consultant prior to placement.
  - 6.2.3 For individual placement, sufficient space shall be provided between rocks to allow for passage of compaction equipment.
  - 6.2.4 For windrow placement, the rocks should be placed in trenches excavated in properly compacted *soil* fill. Trenches should be approximately 5 feet wide and 4 feet deep in maximum dimension. The voids around and beneath rocks should be filled with approved granular soil having a Sand Equivalent of 30 or greater and should be compacted by flooding. Windrows may also be placed utilizing an "open-face" method in lieu of the trench procedure, however, this method should first be approved by the Consultant.

- 6.2.5 Windrows should generally be parallel to each other and may be placed either parallel to or perpendicular to the face of the slope depending on the site geometry. The minimum horizontal spacing for windrows shall be 12 feet center-to-center with a 5-foot stagger or offset from lower courses to next overlying course. The minimum vertical spacing between windrow courses shall be 2 feet from the top of a lower windrow to the bottom of the next higher windrow.
- 6.2.6 Rock placement, fill placement and flooding of approved granular soil in the windrows should be continuously observed by the Consultant.
- 6.3 *Rock* fills, as defined in Section 3.1.3, shall be placed by the Contractor in accordance with the following recommendations:
- 6.3.1 The base of the *rock* fill shall be placed on a sloping surface (minimum slope of 2 percent). The surface shall slope toward suitable subdrainage outlet facilities. The *rock* fills shall be provided with subdrains during construction so that a hydrostatic pressure buildup does not develop. The subdrains shall be permanently connected to controlled drainage facilities to control post-construction infiltration of water.
- 6.3.2 *Rock* fills shall be placed in lifts not exceeding 3 feet. Placement shall be by rock trucks traversing previously placed lifts and dumping at the edge of the currently placed lift. Spreading of the *rock* fill shall be by dozer to facilitate *seating* of the rock. The *rock* fill shall be watered heavily during placement. Watering shall consist of water trucks traversing in front of the current rock lift face and spraying water continuously during rock placement. Compaction equipment with compactive energy comparable to or greater than that of a 20-ton steel vibratory roller or other compaction equipment providing suitable energy to achieve the required compaction or deflection as recommended in Paragraph 6.3.3 shall be utilized. The number of passes to be made should be determined as described in Paragraph 6.3.3. Once a *rock* fill lift has been covered with *soil* fill, no additional *rock* fill lifts will be permitted over the *soil* fill.
- 6.3.3 Plate bearing tests, in accordance with ASTM D 1196, may be performed in both the compacted *soil* fill and in the *rock* fill to aid in determining the required minimum number of passes of the compaction equipment. If performed, a minimum of three plate bearing tests should be performed in the properly compacted *soil* fill (minimum relative compaction of 90 percent). Plate bearing tests shall then be performed on areas of *rock* fill having two passes, four passes and six passes of the compaction equipment, respectively. The number of passes required for the *rock* fill shall be determined by comparing the results of the plate bearing tests for the *soil* fill and the *rock* fill and by evaluating the deflection

variation with number of passes. The required number of passes of the compaction equipment will be performed as necessary until the plate bearing deflections are equal to or less than that determined for the properly compacted *soil* fill. In no case will the required number of passes be less than two.

- 6.3.4 A representative of the Consultant should be present during *rock* fill operations to observe that the minimum number of “passes” have been obtained, that water is being properly applied and that specified procedures are being followed. The actual number of plate bearing tests will be determined by the Consultant during grading.
- 6.3.5 Test pits shall be excavated by the Contractor so that the Consultant can state that, in their opinion, sufficient water is present and that voids between large rocks are properly filled with smaller rock material. In-place density testing will not be required in the *rock* fills.
- 6.3.6 To reduce the potential for “piping” of fines into the *rock* fill from overlying *soil* fill material, a 2-foot layer of graded filter material shall be placed above the uppermost lift of *rock* fill. The need to place graded filter material below the *rock* should be determined by the Consultant prior to commencing grading. The gradation of the graded filter material will be determined at the time the *rock* fill is being excavated. Materials typical of the *rock* fill should be submitted to the Consultant in a timely manner, to allow design of the graded filter prior to the commencement of *rock* fill placement.
- 6.3.7 *Rock* fill placement should be continuously observed during placement by the Consultant.

## 7. SUBDRAINS

- 7.1 The geologic units on the site may have permeability characteristics and/or fracture systems that could be susceptible under certain conditions to seepage. The use of canyon subdrains may be necessary to mitigate the potential for adverse impacts associated with seepage conditions. Canyon subdrains with lengths in excess of 500 feet or extensions of existing offsite subdrains should use 8-inch-diameter pipes. Canyon subdrains less than 500 feet in length should use 6-inch-diameter pipes.

## TYPICAL CANYON DRAIN DETAIL

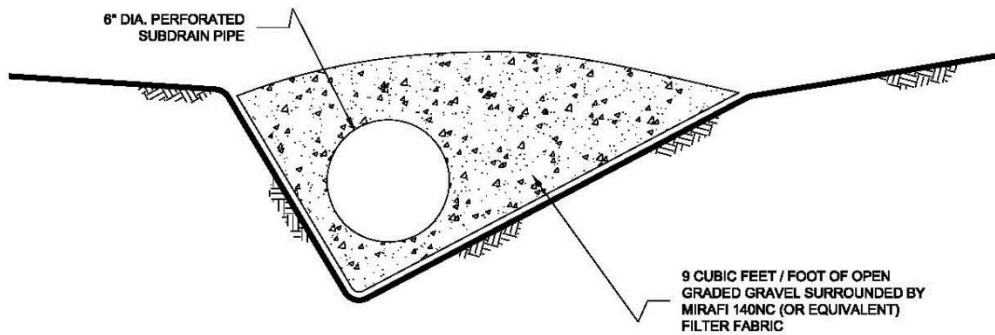
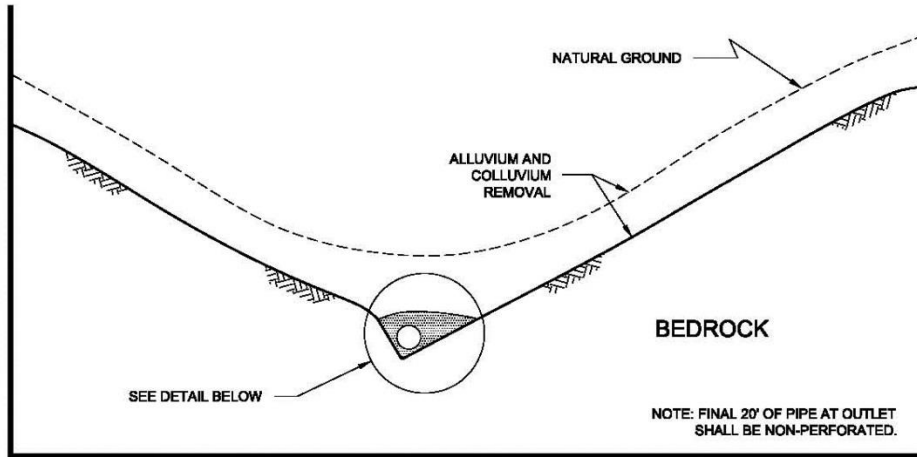

### NOTES:

- 1.....8-INCH DIAMETER, SCHEDULE 80 PVC PERFORATED PIPE FOR FILLS IN EXCESS OF 100-FEET IN DEPTH OR A PIPE LENGTH OF LONGER THAN 500 FEET.
- 2.....6-INCH DIAMETER, SCHEDULE 40 PVC PERFORATED PIPE FOR FILLS LESS THAN 100-FEET IN DEPTH OR A PIPE LENGTH SHORTER THAN 500 FEET.

NO SCALE

7.2 Slope drains within stability fill keyways should use 4-inch-diameter (or larger) pipes.

## TYPICAL STABILITY FILL DETAIL

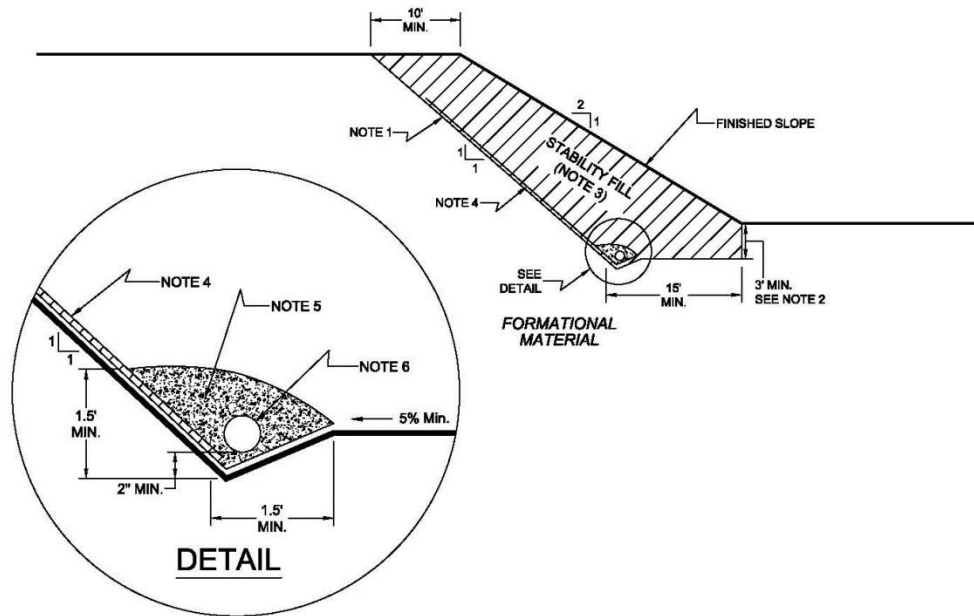

### NOTES:

- 1.....EXCAVATE BACKCUT AT 1:1 INCLINATION (UNLESS OTHERWISE NOTED).
- 2.....BASE OF STABILITY FILL TO BE 3 FEET INTO FORMATIONAL MATERIAL, SLOPING A MINIMUM 5% INTO SLOPE.
- 3.....STABILITY FILL TO BE COMPOSED OF PROPERLY COMPACTED GRANULAR SOIL.
- 4.....CHIMNEY DRAINS TO BE APPROVED PREFABRICATED CHIMNEY DRAIN PANELS (MIRADRAIN G200N OR EQUIVALENT) SPACED APPROXIMATELY 20 FEET CENTER TO CENTER AND 4 FEET WIDE. CLOSER SPACING MAY BE REQUIRED IF SEEPAGE IS ENCOUNTERED.
- 5.....FILTER MATERIAL TO BE 3/4-INCH, OPEN-GRADED CRUSHED ROCK ENCLOSED IN APPROVED FILTER FABRIC (MIRAFI 140NC).
- 6.....COLLECTOR PIPE TO BE 4-INCH MINIMUM DIAMETER, PERFORATED, THICK-WALLED PVC SCHEDULE 40 OR EQUIVALENT, AND SLOPED TO DRAIN AT 1 PERCENT MINIMUM TO APPROVED OUTLET.

NO SCALE

7.3 The actual subdrain locations will be evaluated in the field during the remedial grading operations. Additional drains may be necessary depending on the conditions observed and the requirements of the local regulatory agencies. Appropriate subdrain outlets should be evaluated prior to finalizing 40-scale grading plans.

7.4 *Rock fill* or *soil-rock fill* areas may require subdrains along their down-slope perimeters to mitigate the potential for buildup of water from construction or landscape irrigation. The subdrains should be at least 6-inch-diameter pipes encapsulated in gravel and filter fabric. *Rock fill* drains should be constructed using the same requirements as canyon subdrains.

7.5 Prior to outletting, the final 20-foot segment of a subdrain that will not be extended during future development should consist of non-perforated drainpipe. At the non-perforated/perforated interface, a seepage cutoff wall should be constructed on the downslope side of the pipe.

TYPICAL CUT OFF WALL DETAIL

FRONT VIEW

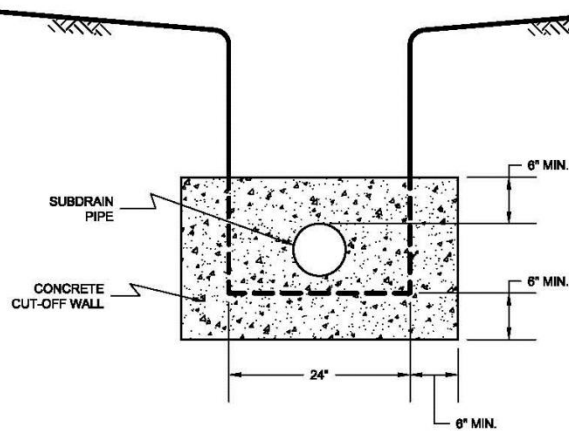

NO SCALE

SIDE VIEW

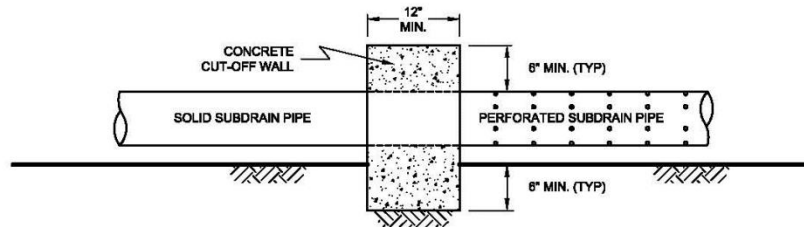

NO SCALE

7.6 Subdrains that discharge into a natural drainage course or open space area should be provided with a permanent headwall structure.

## TYPICAL HEADWALL DETAIL

### FRONT VIEW

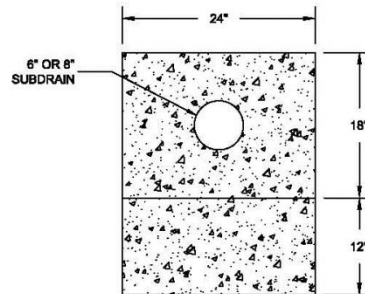

NO SCALE

### SIDE VIEW

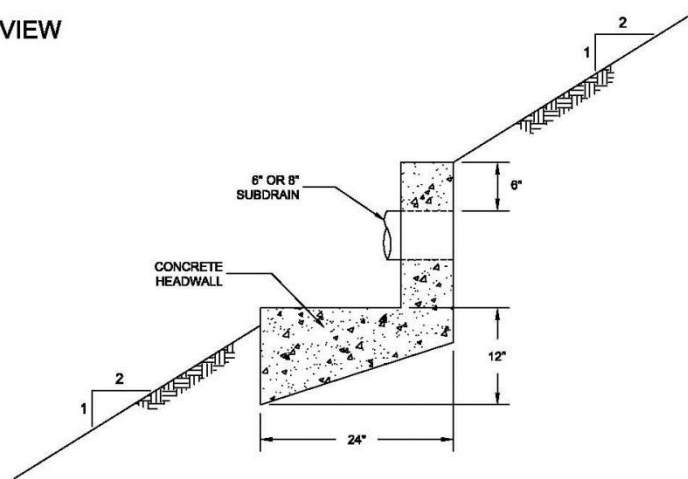

NOTE: HEADWALL SHOULD OUTLET AT TOE OF FILL SLOPE  
OR INTO CONTROLLED SURFACE DRAINAGE

NO SCALE

- 7.7 The final grading plans should show the location of the proposed subdrains. After completion of remedial excavations and subdrain installation, the project civil engineer should survey the drain locations and prepare an “as-built” map showing the drain locations. The final outlet and connection locations should be determined during grading operations. Subdrains that will be extended on adjacent projects after grading can be placed on formational material and a vertical riser should be placed at the end of the subdrain. The grading contractor should consider videoing the subdrains shortly after burial to check proper installation and functionality. The contractor is responsible for the performance of the drains.



## 8. OBSERVATION AND TESTING

- 8.1 The Consultant shall be the Owner's representative to observe and perform tests during clearing, grubbing, filling, and compaction operations. In general, no more than 2 feet in vertical elevation of *soil* or *soil-rock* fill should be placed without at least one field density test being performed within that interval. In addition, a minimum of one field density test should be performed for every 2,000 cubic yards of *soil* or *soil-rock* fill placed and compacted.
- 8.2 The Consultant should perform a sufficient distribution of field density tests of the compacted *soil* or *soil-rock* fill to provide a basis for expressing an opinion whether the fill material is compacted as specified. Density tests shall be performed in the compacted materials below any disturbed surface. When these tests indicate that the density of any layer of fill or portion thereof is below that specified, the particular layer or areas represented by the test shall be reworked until the specified density has been achieved.
- 8.3 During placement of *rock* fill, the Consultant should observe that the minimum number of passes have been obtained per the criteria discussed in Section 6.3.3. The Consultant should request the excavation of observation pits and may perform plate bearing tests on the placed *rock* fills. The observation pits will be excavated to provide a basis for expressing an opinion as to whether the *rock* fill is properly seated and sufficient moisture has been applied to the material. When observations indicate that a layer of *rock* fill or any portion thereof is below that specified, the affected layer or area shall be reworked until the *rock* fill has been adequately seated and sufficient moisture applied.
- 8.4 A settlement monitoring program designed by the Consultant may be conducted in areas of *rock* fill placement. The specific design of the monitoring program shall be as recommended in the Conclusions and Recommendations section of the project Geotechnical Report or in the final report of testing and observation services performed during grading.
- 8.5 We should observe the placement of subdrains, to check that the drainage devices have been placed and constructed in substantial conformance with project specifications.
- 8.6 Testing procedures shall conform to the following Standards as appropriate:

### 8.6.1 Soil and Soil-Rock Fills:

- 8.6.1.1 Field Density Test, ASTM D 1556, *Density of Soil In-Place By the Sand-Cone Method.*

- 8.6.1.2 Field Density Test, Nuclear Method, ASTM D 6938, *Density of Soil and Soil-Aggregate In-Place by Nuclear Methods (Shallow Depth)*.
- 8.6.1.3 Laboratory Compaction Test, ASTM D 1557, *Moisture-Density Relations of Soils and Soil-Aggregate Mixtures Using 10-Pound Hammer and 18-Inch Drop*.
- 8.6.1.4. Expansion Index Test, ASTM D 4829, *Expansion Index Test*.

## **9. PROTECTION OF WORK**

- 9.1 During construction, the Contractor shall properly grade all excavated surfaces to provide positive drainage and prevent ponding of water. Drainage of surface water shall be controlled to avoid damage to adjoining properties or to finished work on the site. The Contractor shall take remedial measures to prevent erosion of freshly graded areas until such time as permanent drainage and erosion control features have been installed. Areas subjected to erosion or sedimentation shall be properly prepared in accordance with the Specifications prior to placing additional fill or structures.
- 9.2 After completion of grading as observed and tested by the Consultant, no further excavation or filling shall be conducted except in conjunction with the services of the Consultant.

## **10. CERTIFICATIONS AND FINAL REPORTS**

- 10.1 Upon completion of the work, Contractor shall furnish Owner a certification by the Civil Engineer stating that the lots and/or building pads are graded to within 0.1 foot vertically of elevations shown on the grading plan and that all tops and toes of slopes are within 0.5 foot horizontally of the positions shown on the grading plans. After installation of a section of subdrain, the project Civil Engineer should survey its location and prepare an *as-built* plan of the subdrain location. The project Civil Engineer should verify the proper outlet for the subdrains and the Contractor should ensure that the drain system is free of obstructions.
- 10.2 The Owner is responsible for furnishing a final as-graded soil and geologic report satisfactory to the appropriate governing or accepting agencies. The as-graded report should be prepared and signed by a California licensed Civil Engineer experienced in geotechnical engineering and by a California Certified Engineering Geologist, indicating that the geotechnical aspects of the grading were performed in substantial conformance with the Specifications or approved changes to the Specifications.

## LIST OF REFERENCES

1. City of San Diego (2008), Seismic Safety Study, Geologic Hazards and Faults, Grid Tile 6, dated April 3, 2008;
2. FEMA (2012), *Flood Map Service Center*, FEMA website, <https://msc.fema.gov/portal/home>, flood map number 06073C2159G, effective May 16, 2012, accessed January 15, 2020;
3. Geocon Incorporated, *Geotechnical Investigation, Nakano Property, Dennery Ranch Area, Chula Vista, California*, dated May 10, 2005 (Project No. 07516-42-01).
4. Jennings, C. W., 1994, California Division of Mines and Geology, *Fault Activity Map of California and Adjacent Areas*, California Geologic Data Map Series Map No. 6.
5. Kennedy, M. P., and S. S. Tan, 2005, *Geologic Map of the San Diego 30'x60' Quadrangle, California*, USGS Regional Map Series Map No. 3, Scale 1:100,000.
6. SEAOC (2019), *OSHPD Seismic Design Maps: Structural Engineers Association of California* website, <http://seismicmaps.org/>, accessed December 10, 2018;
7. USGS (2019), *Quaternary Fault and Fold Database of the United States: U.S. Geological Survey* website, <https://www.usgs.gov/natural-hazards/earthquake-hazards/faults>, accessed January 14, 2020;
8. Unpublished reports and maps on file with Geocon Incorporated.