



# Converse Consultants

*Geotechnical Engineering, Environmental & Groundwater Science, Inspection & Testing Services*

September 25, 2023

County of San Diego  
Dept. of Environmental Health & Quality  
Site Assessment & Mitigation Program  
5500 Overland Avenue,  
San Diego, CA 92123

Attention: Ewan Moffat, Hydrogeologist  
Program Coordinator

Subject **TriPointe Homes - Nakano Property – Request for Case Closure**  
APN 624-071-02-00  
DEH2022 LSAM-000697  
Converse Project No 02-41-345-05

Mr. Moffat:

Converse Consultants (Converse) is pleased to present this Request for Case Closure letter for the above referenced property. The subject property (herein referred to as the Property or Nakano Property) is comprised of 23-acres of land in the city of Chula Vista, California. The Property is generally located east of the 805 (Jacob Dekma) Freeway (approximately 100 feet), south of the Otay River (approximately 300 feet), and north of Palm Avenue (approximately 1,500 feet). The approximate location of the Property is indicated on Figure 1.

The Property is currently owned by TriPointe Homes (formerly by Pardee Homes). In April 2022 the Property was enrolled in the Voluntary Assistance Program (VAP) of the San Diego County Department of Environmental Health and Quality (DEHQ) seeking regulatory closure with regard to two (2) previously identified recognized environmental conditions (RECs):

- Pesticides in shallow soils in the vicinity of former onsite pesticide storage.
- Hydrocarbons in the vicinity of one (1) boring completed at the Property.

Environmental assessment activities were completed at the Property between August 2000 and November 2006. Relevant portions of available reports were previously submitted to DEHQ for review. As noted in those reports the Nakano Property was historically used for agricultural purposes. Pesticides and diesel fuel were stored onsite for use associated with the agricultural activities. The prior environmental assessments included the collection of soil samples which were submitted for laboratory analysis of one or more of the following:

- Total Petroleum Hydrocarbons (TPH) and/or Total Recoverable Petroleum Hydrocarbons (TRPH)

- Organochlorine Pesticides (OCPs)
- Organophosphorus Pesticides (OPPs)
- Chlorinated Herbicides (CHs)
- Metals
- Polychlorinated Biphenyls (PCBs)
- Volatile Organic Compounds (VOCs)
- Semi-volatile Organic Compounds (SVOCs)

Locations of the various assessment sample locations are indicated on Figure 2. Reported concentrations of TPH, OCPs/OPPs/CHs, and metals are presented on Figure 3A/3B, 4, and 5, respectively.

The Phase II activities completed on June 28, 2000 included 8 borings for general screening of the Property (SP-1 through SP-8), as well as soil samples collected adjacent to the pesticide storage trailer (SP-9) and above ground storage tank (AST) used for diesel fuel (SP-10). On March 13, 2003 Converse completed five (5) additional borings along the northern boundary of the Property (GP-1 through GP-5) to evaluate for potential impacts from metals and hydrocarbons, and three (3) (GP-6 through GP-8) to evaluate for pesticides OCPs near the pesticide storage trailer.

Findings for these assessment activities revealed the following:

- The maximum concentrations of all detected OCPs (DDD, DDE, and DDT) were reported in the sample collected adjacent to the pesticides storage trailer (SP-9) at 83, 118, and 326 micrograms per kilogram (ug/kg), respectively. Despite these concentrations being less than regulatory threshold values of that time, they were noted as being “elevated” relative to levels reported in other samples. No OCPs were reported in any of the other samples from borings completed in the vicinity of location SP-9. It is noted that all prior OCP concentrations are less than current residential Environmental Screening Level (ESL) values of 2,700 ug/kg for DDD, 1,800 ug/kg for DDE, and 1,900 ug/kg for DDT.
- TPH was not detected in the soil sample collected from the location (SP-10) adjacent to the AST. However, a maximum TRPH concentration of 861 milligrams per kilogram (mg/kg) was reported in the soil sample from 5 feet below ground surface (bgs) at location GP-1. Although all reported TRPH concentrations were less than the lowest Maximum Soil Screening Level (MSSL) of 1,000 mg/kg (or parts per million (ppm)) for diesel range TPH, further assessment was recommended in the vicinity of boring location GP-1 to evaluate potentially elevated TPH concentrations.

On both April 18 and September 2, 2003 a total of eight (8) additional borings were advanced in the vicinity of prior boring location GP-1 (GP-1b through GP-1e, and GP-19 through GP-22) with soil samples collected from depths of 5 and 10 feet bgs analyzed for TPH and/or TRPH. TPH in the diesel and oil ranges was reported at maximum concentrations of 43.6 and 127 mg/kg, which were both less than their respective MSSL values of 1,000 and 10,000 mg/kg. TRPH was reported at maximum concentrations of 1,230 and 1,280 mg/kg in soil samples from locations GP-1c and GP-1e, with the next highest TRPH concentration being 243 mg/kg. The TRPH

concentrations at location GP-1c and GP-1e were considered to be of potential concern since they could have represented diesel range hydrocarbons, in which case they would have been slightly in excess of the MSSL value for diesel of 1,000 mg/kg. However, based on ratio of TRPH to TPH diesel concentrations reported in other samples in this portion of the Property this appears to have been a very conservative assumption (see concentrations presented on Figure 3B).

Based on recent internal review of these prior assessment reports and the summaries presented above, Converse presents the following conclusions and recommendations:

- The previous recommendation to excavate and dispose of soils in the vicinity of the former pesticide trailer is believed to have been made out of an abundance of caution, and relative to lower concentrations in samples from surrounding areas. However, all previously reported OCP concentrations are less than current threshold values.
- The recommendation made at the time to excavate and dispose of the soils in the vicinity of locations GP-1c and GP-1e is believed to have been made based on a very conservative assumption on the percent of TRPH concentrations that might be representative of TPH diesel concentrations. However, based on the ratio of TRPH to TPH diesel concentrations reported in other samples in this portion of the Property, this appears to have been a very conservative assumption.
- Since the concentrations of OCPs and TPH previously reported in soil samples from the Property are all less than current regulatory thresholds for residential land use, it is recommended that case closure be granted without requiring any further assessment or remedial activities.

We appreciate your consideration of this request for case closure. Please don't hesitate to contact the undersigned at (626) 930-1267 or (626) 930-1260, respectively, should you have any questions.

**Converse Consultants**

  
Michael Van Fleet, PG  
Senior Geologist

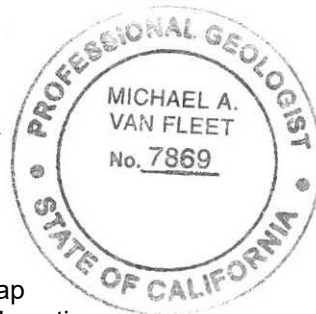

  
Norman Eke  
Managing Officer

- Attach; Figure 1 – Site Location Map  
Figure 2 – All Soil Sample Locations  
Figure 3A – Soil Sampling Location - TPH  
Figure 3B – Soil Sampling Location - TPH  
Figure 4 – Soil Sampling Location - OCPs  
Figure 5 – Soil Sampling Location – CHs/Opps/PCBs

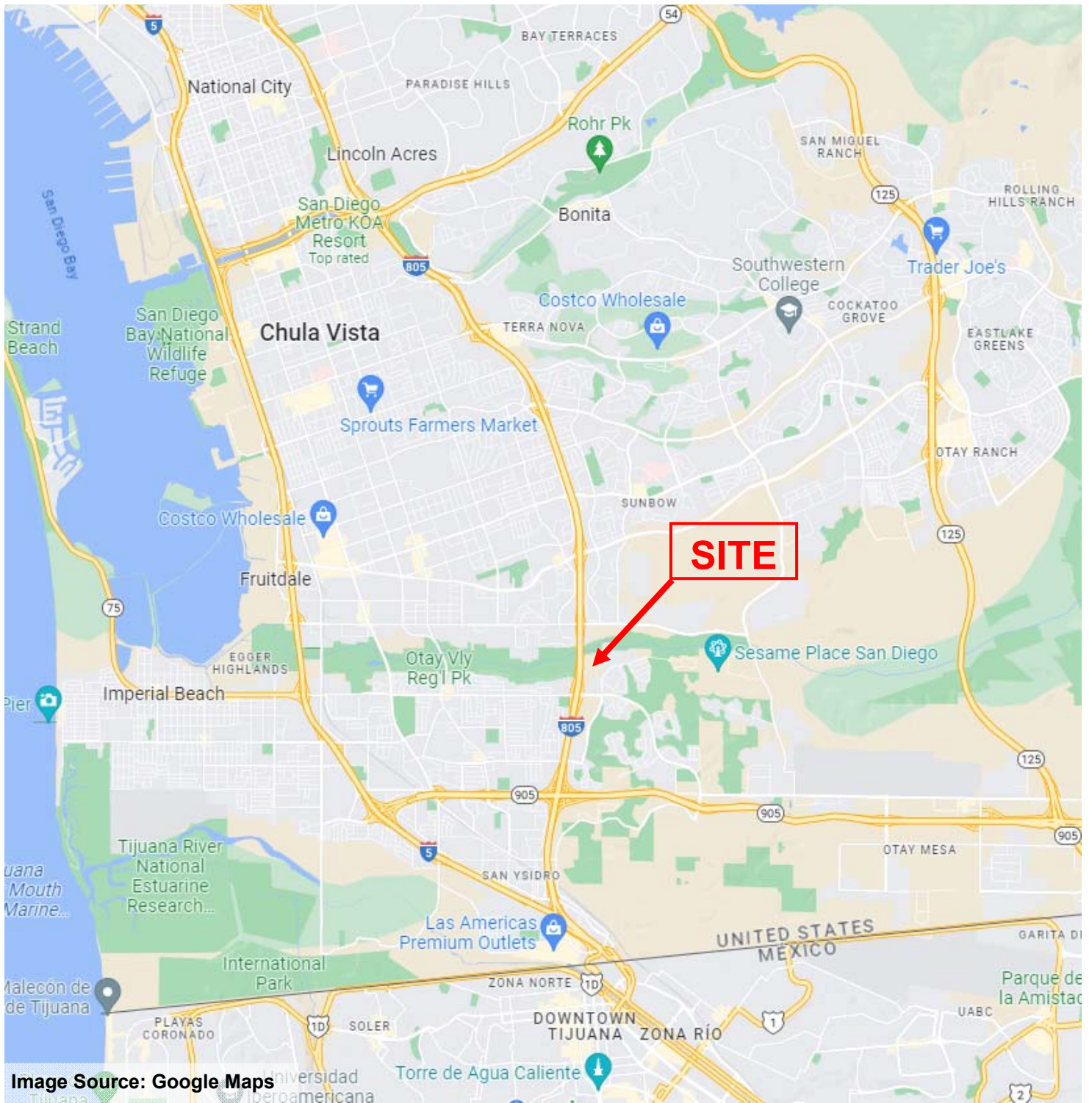

Image Source: Google Maps

## SITE LOCATION MAP



TriPointe (Pardee) Homes  
 Nakano Property  
 Chula Vista, California

Project No:

02-41-345-05



**Converse Consultants**

FIGURE 1

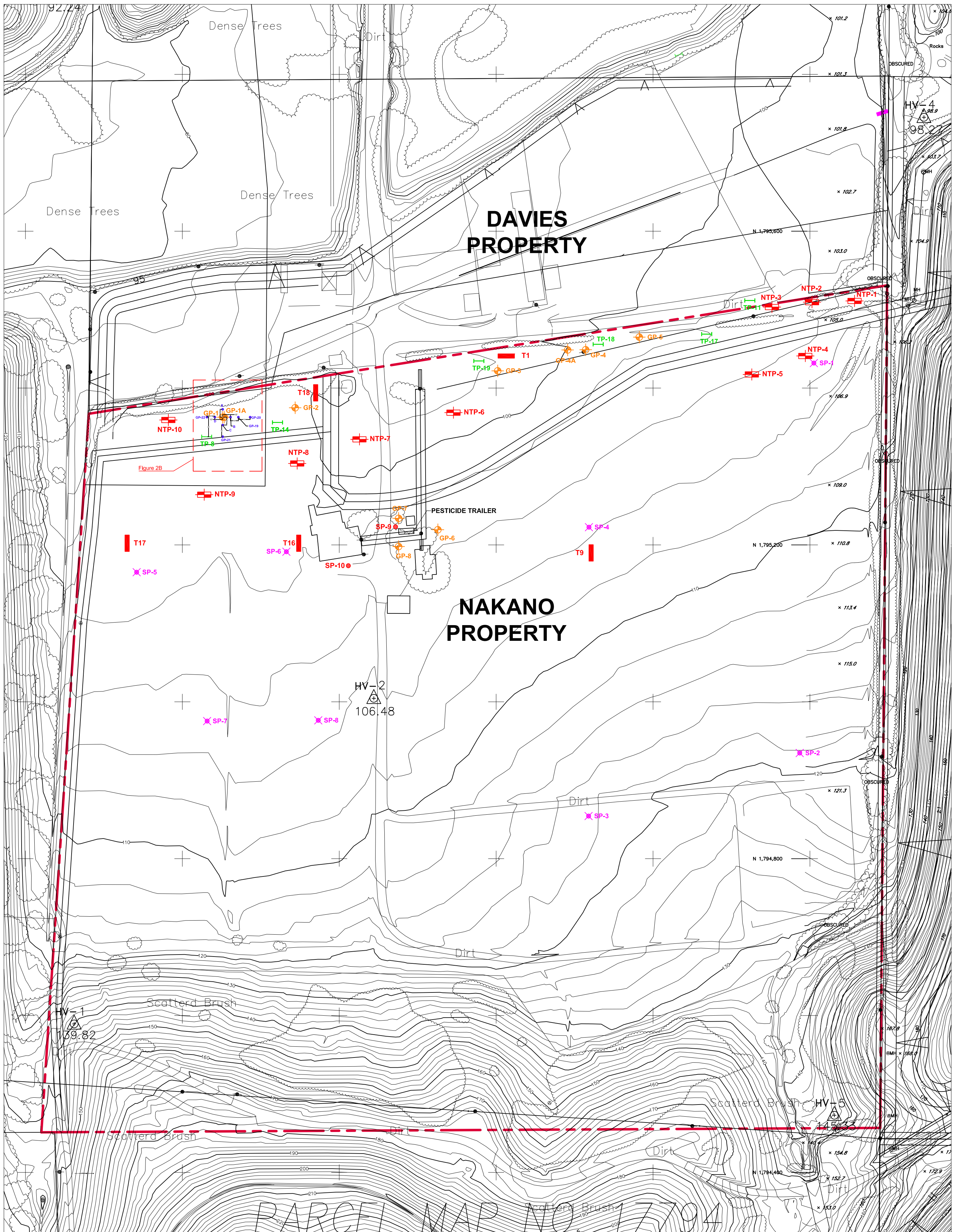

**LEGEND**

- █ PACIFIC SOILS TEST PITS
- ▬ TRENCHES / TEST PITS-OCTOBER 2006
- ▬ TEST PITS-SEPTEMBER 2003
- SOIL SAMPLING-MARCH 2003
- SOIL SAMPLING-APRIL & SEPTEMBER 2003 STEP OUTS
- ✕ SOIL SAMPLING-AUGUST 2000
- SOIL SAMPLING-2002

Af FILL  
Qal ALLUVIUM

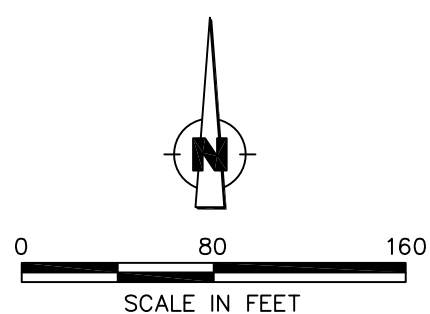

**ALL SOIL SAMPLING LOCATIONS**

PARDEE HOMES  
NAKANO PROPERTY  
CHULA VISTA, CA

Scale 1"=80' Project No. 02-41-345-03  
Date NOV. 2006 Figure No.

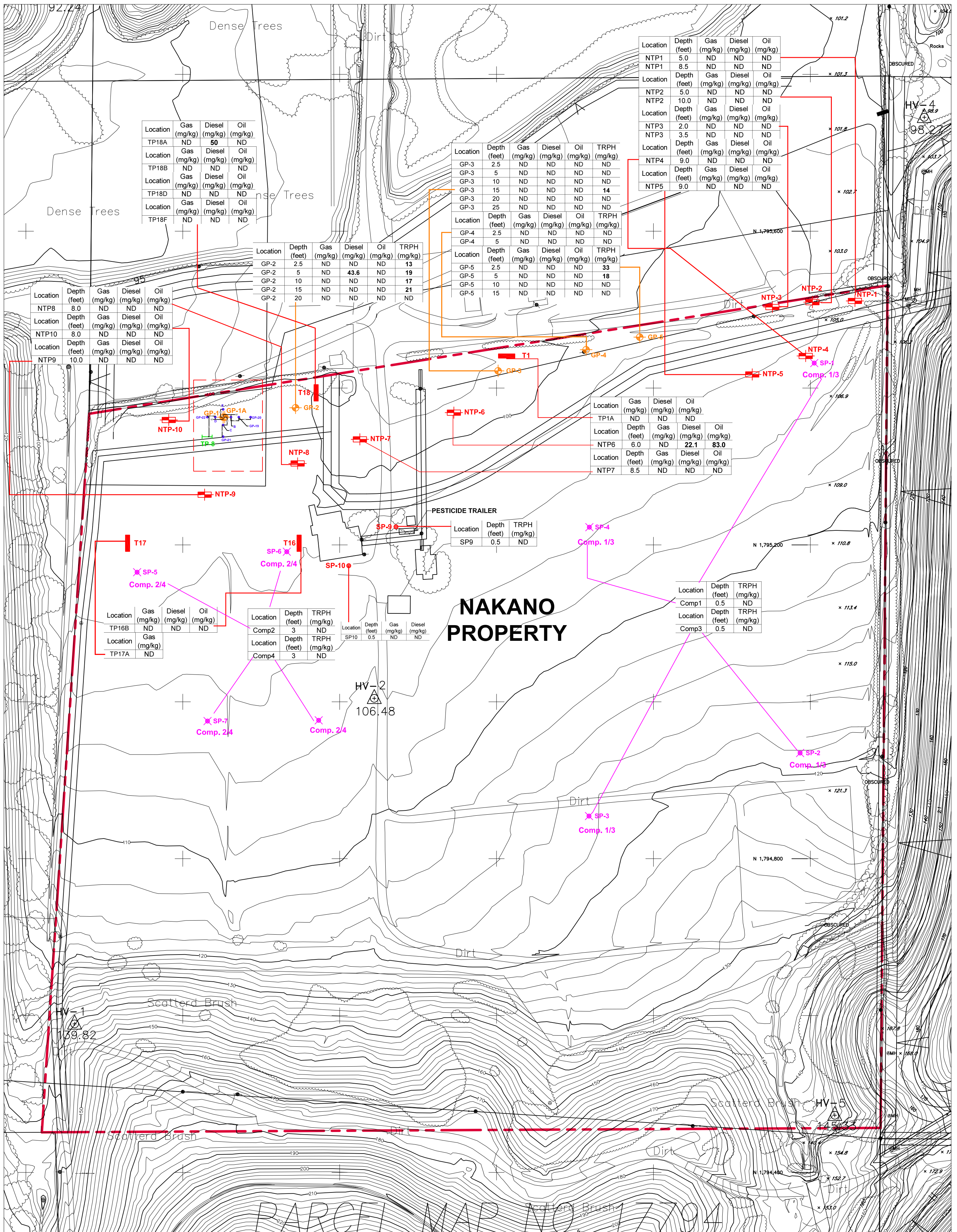

Location	Gas (mg/kg)	Diesel (mg/kg)	Oil (mg/kg)
TP18A	ND	50	ND
Location	Gas (mg/kg)	Diesel (mg/kg)	Oil (mg/kg)
TP18B	ND	ND	ND
Location	Gas (mg/kg)	Diesel (mg/kg)	Oil (mg/kg)
TP18D	ND	ND	ND
Location	Gas (mg/kg)	Diesel (mg/kg)	Oil (mg/kg)
TP18F	ND	ND	ND

Location	Depth (feet)	Gas (mg/kg)	Diesel (mg/kg)	Oil (mg/kg)	TRPH (mg/kg)
GP-2	2.5	ND	ND	ND	13
GP-2	5	ND	43.6	ND	19
GP-2	10	ND	ND	ND	17
GP-2	15	ND	ND	ND	21
GP-2	20	ND	ND	ND	ND

Location	Depth (feet)	Gas (mg/kg)	Diesel (mg/kg)	Oil (mg/kg)	TRPH (mg/kg)
GP-3	2.5	ND	ND	ND	ND
GP-3	5	ND	ND	ND	ND
GP-3	10	ND	ND	ND	ND
GP-3	15	ND	ND	ND	14
GP-3	20	ND	ND	ND	ND
GP-3	25	ND	ND	ND	ND
Location	Depth (feet)	Gas (mg/kg)	Diesel (mg/kg)	Oil (mg/kg)	TRPH (mg/kg)
GP-4	2.5	ND	ND	ND	ND
GP-4	5	ND	ND	ND	ND
Location	Depth (feet)	Gas (mg/kg)	Diesel (mg/kg)	Oil (mg/kg)	TRPH (mg/kg)
GP-5	2.5	ND	ND	ND	33
GP-5	5	ND	ND	ND	18
GP-5	10	ND	ND	ND	ND
GP-5	15	ND	ND	ND	ND

Location	Depth (feet)	Gas (mg/kg)	Diesel (mg/kg)	Oil (mg/kg)
NTP1	5.0	ND	ND	ND
NTP1	8.5	ND	ND	ND
Location	Depth (feet)	Gas (mg/kg)	Diesel (mg/kg)	Oil (mg/kg)
NTP2	5.0	ND	ND	ND
NTP2	10.0	ND	ND	ND
Location	Depth (feet)	Gas (mg/kg)	Diesel (mg/kg)	Oil (mg/kg)
NTP3	2.0	ND	ND	ND
NTP3	3.5	ND	ND	ND
Location	Depth (feet)	Gas (mg/kg)	Diesel (mg/kg)	Oil (mg/kg)
NTP4	9.0	ND	ND	ND
Location	Depth (feet)	Gas (mg/kg)	Diesel (mg/kg)	Oil (mg/kg)
NTP5	9.0	ND	ND	ND

Location	Gas (mg/kg)	Diesel (mg/kg)	Oil (mg/kg)	
TP1A	ND	ND	ND	
Location	Depth (feet)	Gas (mg/kg)	Diesel (mg/kg)	Oil (mg/kg)
NTP6	6.0	ND	22.1	83.0
Location	Depth (feet)	Gas (mg/kg)	Diesel (mg/kg)	Oil (mg/kg)
NTP7	8.5	ND	ND	ND

Location	Gas (mg/kg)	Diesel (mg/kg)	Oil (mg/kg)
TP16B	ND	ND	ND
Location	Gas (mg/kg)	Diesel (mg/kg)	Oil (mg/kg)
TP17A	ND	ND	ND

Location	Depth (feet)	TRPH (mg/kg)
Comp2	3	ND
Location	Depth (feet)	TRPH (mg/kg)
Comp4	3	ND

Location	Depth (feet)	Gas (mg/kg)	Diesel (mg/kg)
SP10	0.5	ND	ND

**NAKANO PROPERTY**

Location	Depth (feet)	TRPH (mg/kg)
Comp1	0.5	ND
Location	Depth (feet)	TRPH (mg/kg)
Comp3	0.5	ND

- LEGEND**
- PACIFIC SOILS TEST PITS
  - TRENCHES / TEST PITS-OCTOBER 2006
  - SOIL SAMPLING-MARCH 2003
  - SOIL SAMPLING-APRIL & SEPTEMBER 2003 STEP OUTS
  - TEST PITS-SEPTEMBER 2003
  - SOIL SAMPLING-2002
  - Af FILL
  - Qal ALLUVIUM

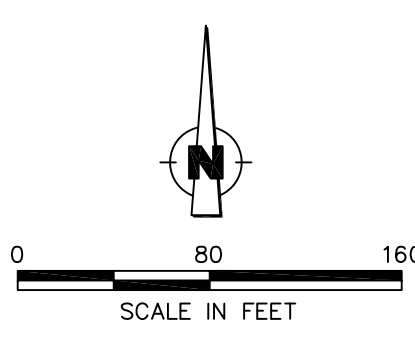

**SOIL SAMPLING LOCATIONS-TPH**

PARDEE HOMES  
NAKANO PROPERTY  
CHULA VISTA, CA

Scale: 1"=80'  
Date: NOV. 2006  
Project No.: 02-41-345-03  
Figure No.: 3A

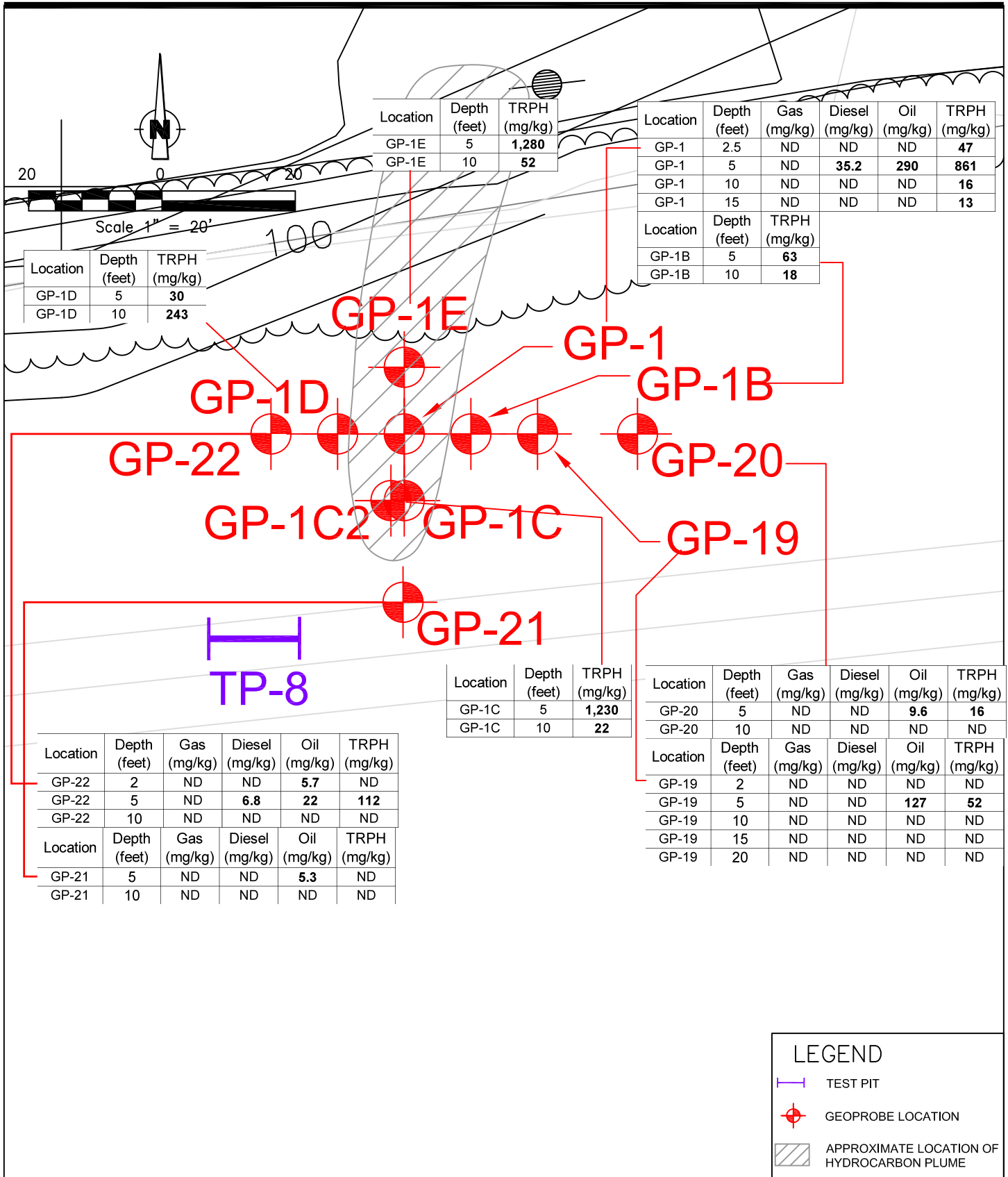

SOIL SAMPLING LOCATIONS-TPH

CLIENT: PARDEE HOMES  
 NAKANO PROPERTY  
 CHULA VISTA, CALIFORNIA

Project No.  
 02-41-345-01

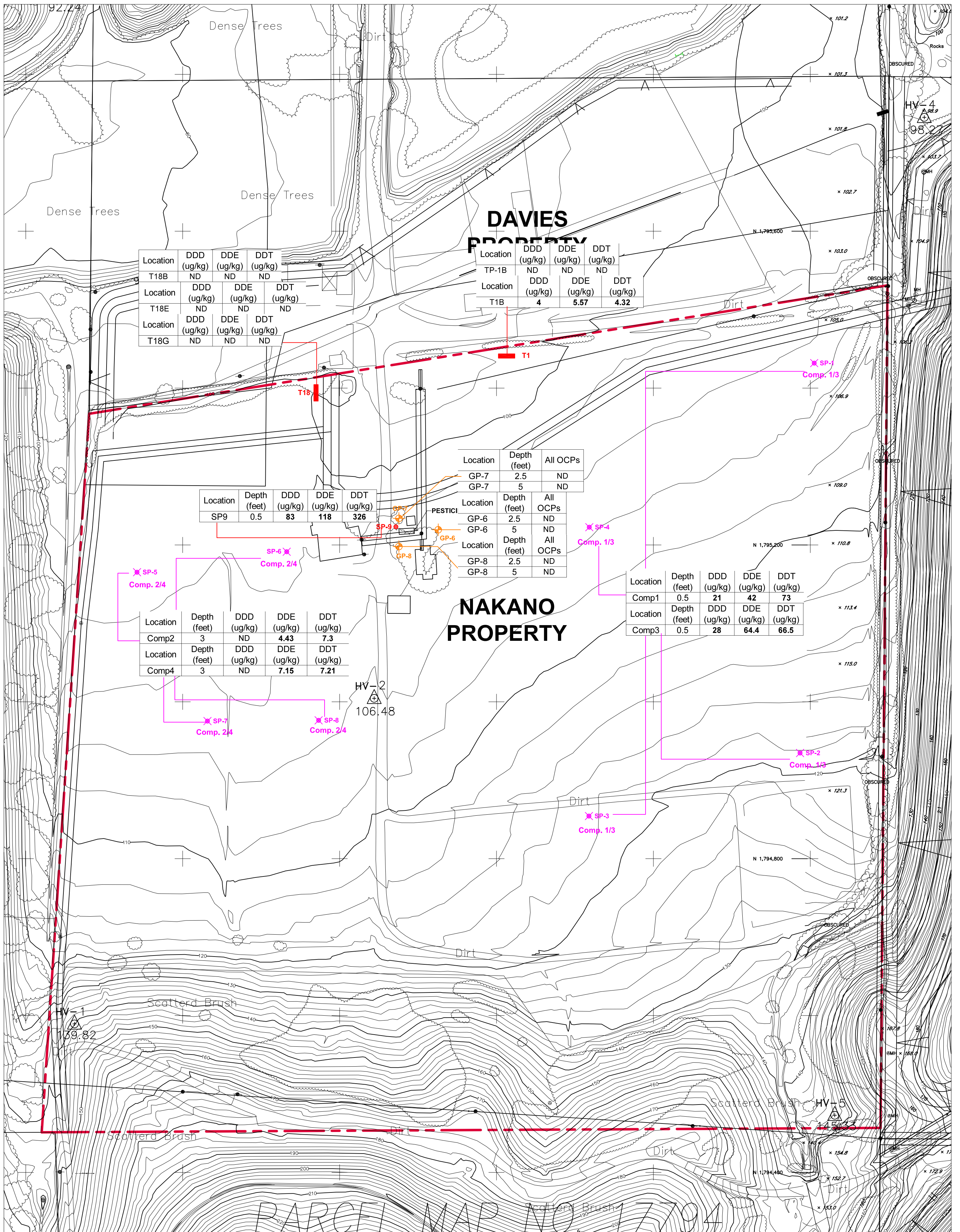

**LEGEND**

- PACIFIC SOILS TEST PITS
- ⊕ SOIL SAMPLING-MARCH 2003
- ⊗ SOIL SAMPLING-AUGUST 2000
- SOIL SAMPLING-2002
- Af FILL
- Qal ALLUVIUM

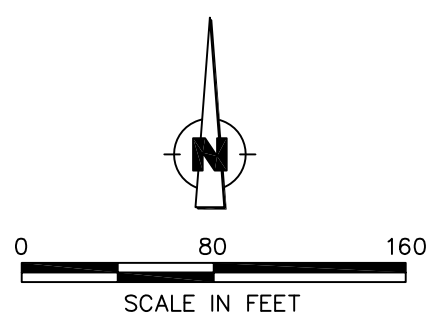

**SOIL SAMPLING LOCATIONS—OCPs**

PARDEE HOMES  
NAKANO PROPERTY  
CHULA VISTA, CA

Scale 1"=80' Project No. 02-41-345-03  
Date NOV. 2006 Figure No.



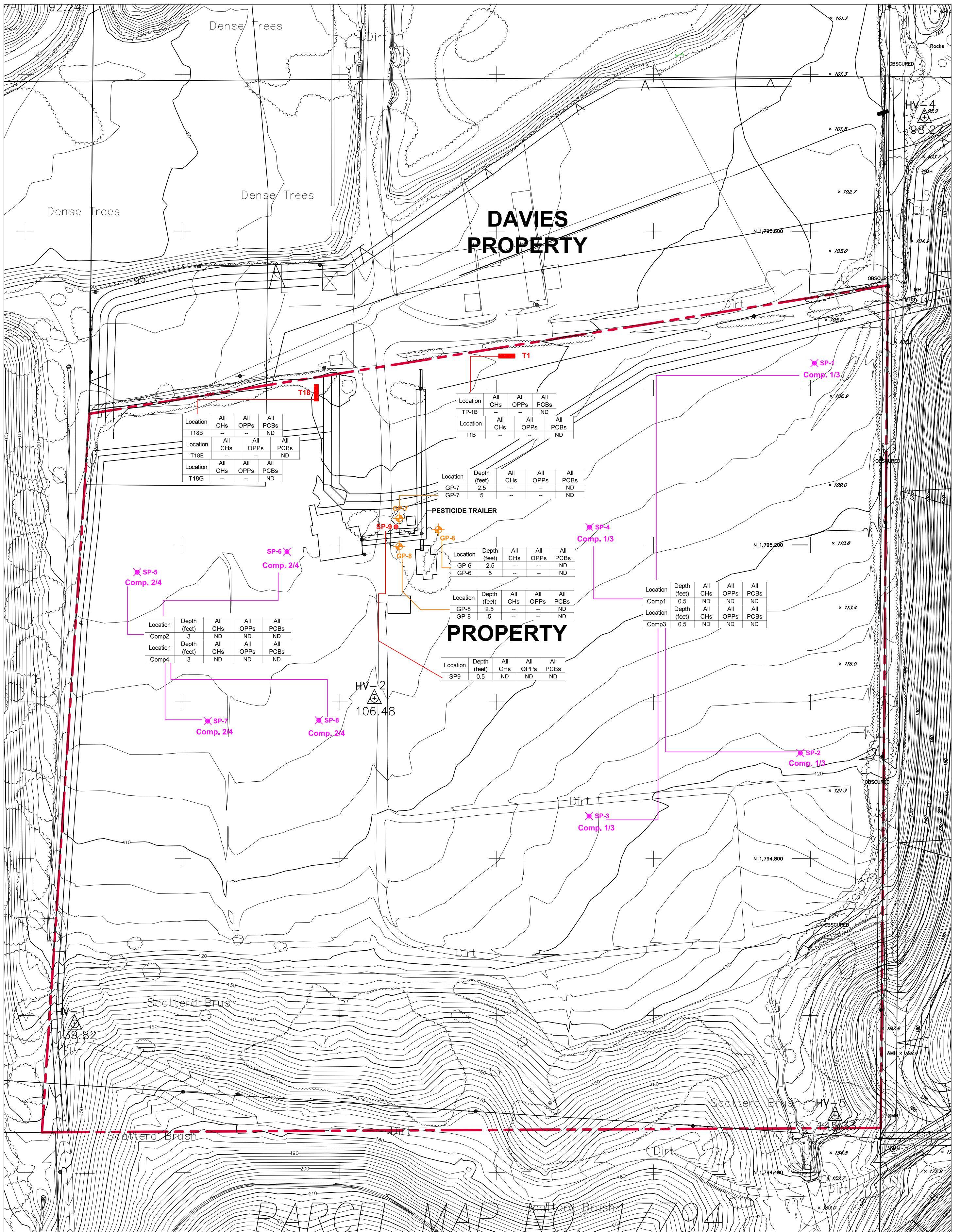

Location	All CHs	All OPPs	All PCBs
T18B	--	--	ND
T18E	--	--	ND
T18G	--	--	ND

Location	All CHs	All OPPs	All PCBs
TP-1B	--	--	ND
T1B	--	--	ND

Location	Depth (feet)	All CHs	All OPPs	All PCBs
GP-7	2.5	--	--	ND
GP-7	5	--	--	ND

Location	Depth (feet)	All CHs	All OPPs	All PCBs
GP-6	2.5	--	--	ND
GP-6	5	--	--	ND

Location	Depth (feet)	All CHs	All OPPs	All PCBs
GP-8	2.5	--	--	ND
GP-8	5	--	--	ND

Location	Depth (feet)	All CHs	All OPPs	All PCBs
SP9	0.5	ND	ND	ND

Location	Depth (feet)	All CHs	All OPPs	All PCBs
Comp1	0.5	ND	ND	ND
Comp3	0.5	ND	ND	ND

Location	Depth (feet)	All CHs	All OPPs	All PCBs
Comp2	3	ND	ND	ND
Comp4	3	ND	ND	ND

- LEGEND**
- PACIFIC SOILS TEST PITS
  - ✖ SOIL SAMPLING-AUGUST 2000
  - SOIL SAMPLING-2002

Af FILL  
Qal ALLUVIUM

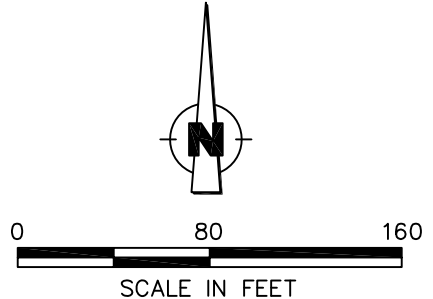

**SOIL SAMPLING LOCATIONS-CHs/OPPs/PCBs**

PARDEE HOMES  
NAKANO PROPERTY  
CHULA VISTA, CA

Scale 1"=80' Project No. 02-41-345-03  
Date NOV. 2006 Figure No.

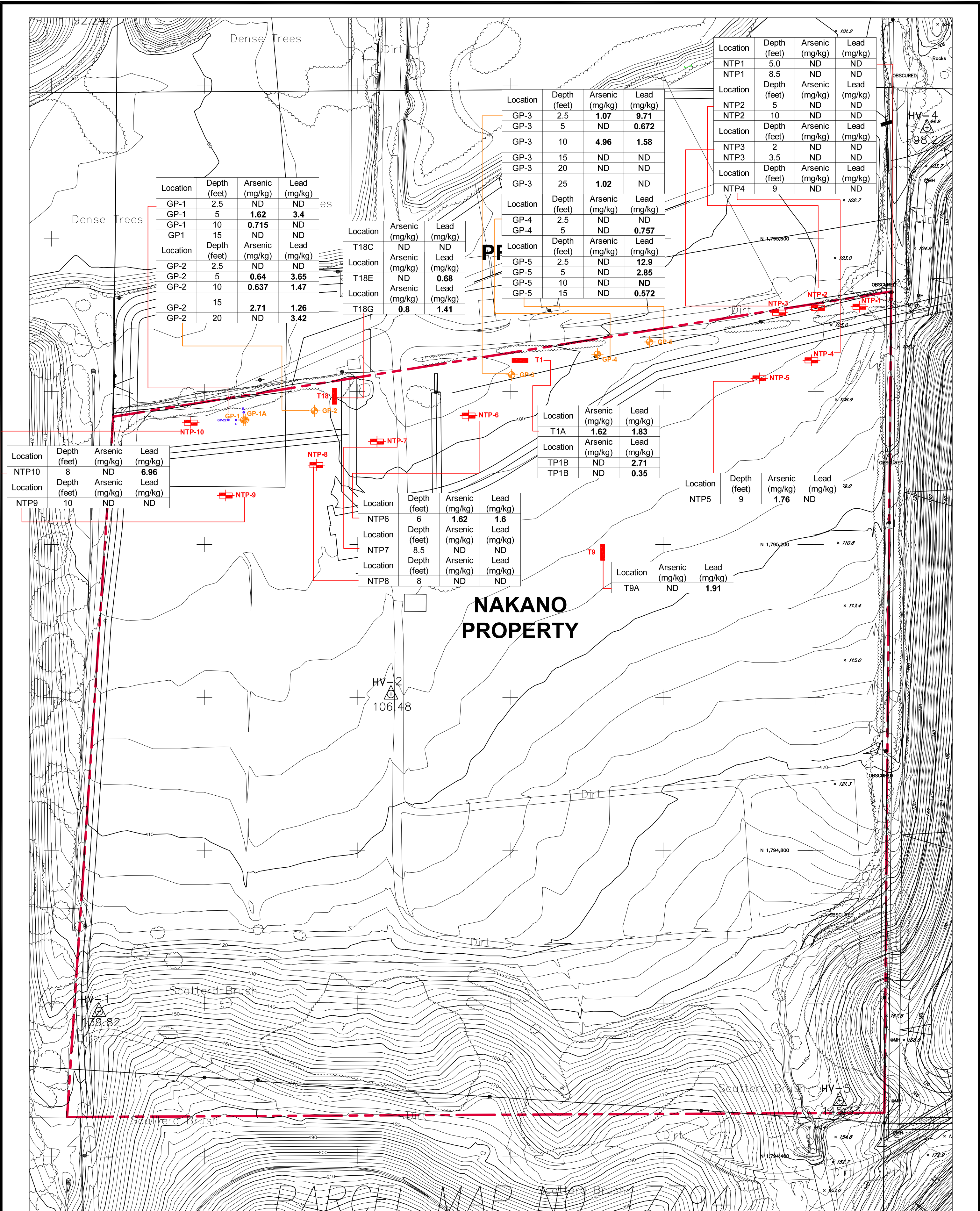

Location	Depth (feet)	Arsenic (mg/kg)	Lead (mg/kg)
GP-1	2.5	ND	ND
GP-1	5	1.62	3.4
GP-1	10	0.715	ND
GP1	15	ND	ND
Location	Depth (feet)	Arsenic (mg/kg)	Lead (mg/kg)
GP-2	2.5	ND	ND
GP-2	5	0.64	3.65
GP-2	10	0.637	1.47
GP-2	15	2.71	1.26
GP-2	20	ND	3.42

Location	Arsenic (mg/kg)	Lead (mg/kg)
T18C	ND	ND
Location	Arsenic (mg/kg)	Lead (mg/kg)
T18E	ND	0.68
Location	Arsenic (mg/kg)	Lead (mg/kg)
T18G	0.8	1.41

Location	Depth (feet)	Arsenic (mg/kg)	Lead (mg/kg)
GP-3	2.5	1.07	9.71
GP-3	5	ND	0.672
GP-3	10	4.96	1.58
GP-3	15	ND	ND
GP-3	20	ND	ND
GP-3	25	1.02	ND

Location	Depth (feet)	Arsenic (mg/kg)	Lead (mg/kg)
GP-4	2.5	ND	ND
GP-4	5	ND	0.757
Location	Depth (feet)	Arsenic (mg/kg)	Lead (mg/kg)
GP-5	2.5	ND	12.9
GP-5	5	ND	2.85
GP-5	10	ND	ND
GP-5	15	ND	0.572

Location	Depth (feet)	Arsenic (mg/kg)	Lead (mg/kg)
NTP1	5.0	ND	ND
NTP1	8.5	ND	ND
Location	Depth (feet)	Arsenic (mg/kg)	Lead (mg/kg)
NTP2	5	ND	ND
NTP2	10	ND	ND
Location	Depth (feet)	Arsenic (mg/kg)	Lead (mg/kg)
NTP3	2	ND	ND
NTP3	3.5	ND	ND
Location	Depth (feet)	Arsenic (mg/kg)	Lead (mg/kg)
NTP4	9	ND	ND

Location	Depth (feet)	Arsenic (mg/kg)	Lead (mg/kg)
NTP10	8	ND	6.96
Location	Depth (feet)	Arsenic (mg/kg)	Lead (mg/kg)
NTP9	10	ND	ND

Location	Depth (feet)	Arsenic (mg/kg)	Lead (mg/kg)
NTP6	6	1.62	1.6
Location	Depth (feet)	Arsenic (mg/kg)	Lead (mg/kg)
NTP7	8.5	ND	ND
Location	Depth (feet)	Arsenic (mg/kg)	Lead (mg/kg)
NTP8	8	ND	ND

Location	Arsenic (mg/kg)	Lead (mg/kg)
T1A	1.62	1.83
Location	Arsenic (mg/kg)	Lead (mg/kg)
TP1B	ND	2.71
TP1B	ND	0.35

Location	Depth (feet)	Arsenic (mg/kg)	Lead (mg/kg)
NTP5	9	1.76	ND

Location	Arsenic (mg/kg)	Lead (mg/kg)
T9A	ND	1.91

## NAKANO PROPERTY

# PARCEL MAP NO. 17794

- LEGEND**
- PACIFIC SOILS TEST PITS
  - TRENCHES / TEST PITS-OCTOBER 2006
  - SOIL SAMPLING-MARCH 2003
  - SOIL SAMPLING-APRIL & SEPTEMBER 2003 STEP OUTS

Af FILL  
Qal ALLUVIUM

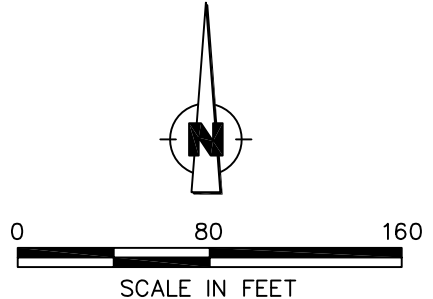

### SOIL SAMPLING LOCATIONS-METALS

PARDEE HOMES  
NAKANO PROPERTY  
CHULA VISTA, CA

Scale 1"=80'  
Date NOV. 2006  
Project No. 02-41-345-03  
Figure No.