

**UPDATE
GEOTECHNICAL INVESTIGATION**

**NAKANO PROPERTY
CHULA VISTA, CALIFORNIA**



GEOCON
INCORPORATED

GEOTECHNICAL
ENVIRONMENTAL
MATERIALS

PREPARED FOR
PARDEE HOMES
SAN DIEGO, CALIFORNIA

SEPTEMBER 18, 2020
PROJECT NO. 07516-42-02



Project No. 07516-42-02
September 18, 2020

Pardee Homes
13400 Sabre Springs Parkway, Suite 200
San Diego, California 92128

Attention: Ms. April Tornillo

Subject: UPDATE GEOTECHNICAL INVESTIGATION
NAKANO PROPERTY
CHULA VISTA, CALIFORNIA

Dear Ms. Tornillo:

In accordance with your authorization, we have prepared this update geotechnical investigation report for the proposed residential development at the subject site. The site is underlain by undocumented fill, colluvium, and alluvium, overlying Terrace Deposits and the Mission Valley Formation. The accompanying report presents the results of our study and conclusions and recommendations regarding geotechnical aspects of site development.

This report is based on previous and recent field observations in 2005 and 2020. It is our opinion, based on the results of this study, that the subject site is suitable for development. The accompanying report presents conclusions and recommendations regarding geotechnical aspects of development.

Should you have questions regarding this investigation, or if we may be of further service, please contact the undersigned at your convenience.

Very truly yours,

GEOCON INCORPORATED

Rodney C. Mikesell
GE 2533

RCM:RSA:dmc

(e-mail) Addressee



Rupert S. Adams
CEG 2561

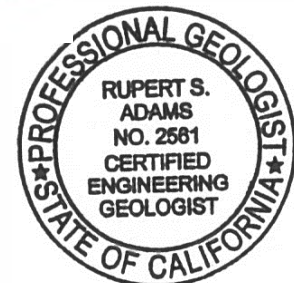

TABLE OF CONTENTS

1.	PURPOSE AND SCOPE	1
2.	SITE AND PROJECT DESCRIPTION	1
3.	SOIL AND GEOLOGIC CONDITIONS	2
3.1	Undocumented Fill (Qudf)	2
3.2	Topsoil (Unmapped).....	3
3.3	Alluvium (Qal)	3
3.4	Colluvium (Qcol).....	3
3.5	Terrace Deposits (Qt)	3
3.6	Mission Valley Formation (Tmv).....	3
4.	GROUNDWATER	4
5.	GEOLOGIC HAZARDS	4
5.1	Faulting and Seismicity	4
5.2	Ground Rupture	6
5.3	Tsunamis and Seiches.....	6
5.4	Flooding.....	6
5.5	Liquefaction and Seismically Induced Settlement.....	7
5.6	Landslides.....	7
5.7	Geologic Hazard Category	7
6.	CONCLUSIONS AND RECOMMENDATIONS.....	8
6.1	General.....	8
6.2	Soil and Excavation Characteristics	9
6.3	Grading Recommendations	10
6.4	Slopes.....	12
6.5	Seismic Design Criteria (2019)	13
6.6	Foundations	15
6.7	Conventional Retaining Wall Recommendations.....	21
6.8	Lateral Loading.....	24
6.9	Preliminary Pavement Recommendations	25
6.10	Exterior Concrete Flatwork	27
6.11	Slope Maintenance.....	29
6.12	Storm Water Management.....	29
6.13	Site Drainage and Moisture Protection.....	30
6.14	Grading and Foundation Plan Review	30

MAPS AND ILLUSTRATIONS

- Figure 1, Vicinity Map
- Figure 2, Geologic Map
- Figures 3 and 4, Geologic Cross-Sections
- Figure 5, Construction Detail for Lateral Extent of Removal
- Figures 6 – 9, Slope Stability Analyses

APPENDIX A

FIELD INVESTIGATION

- Figure A-1, Log of Large Diameter Boring
- Figures A-2 – A-23, Logs of Exploratory Trenches

TABLE OF CONTENTS (Concluded)

APPENDIX B

LABORATORY TESTING

Table B-I, Summary of Laboratory Expansion Index Test Results

Table B-II, Summary of Laboratory Maximum Dry Density and Optimum Moisture Content Test Results

Table B-III, Summary of Laboratory Direct Shear Test Results

Table B-IV, Summary of Laboratory Water-Soluble Sulfate Test Results

Direct Shear Tests

APPENDIX C

STORM WATER MANAGEMENT RECOMMENDATIONS

APPENDIX D

RECOMMENDED GRADING SPECIFICATIONS

LIST OF REFERENCES

UPDATE GEOTECHNICAL INVESTIGATION

1. PURPOSE AND SCOPE

This report presents the results of our update geotechnical investigation for the proposed 157-lot residential development located on the Nakano Property northwest of Dennery Road, east of Interstate 805 (I-805), and south of the Otay River in Chula Vista, California (see Vicinity Map, Figure 1). The purpose of our update investigation was to further evaluate subsurface soil and geologic conditions at the site, and provide updated conclusions and recommendations pertaining to the geotechnical aspects of developing the property as proposed.

The scope of our update investigation included a site reconnaissance, excavation of one large diameter boring to a depth of 71 feet near the southwest corner of the property, performing infiltration testing in the area of the proposed BMPs, and reviewing published and unpublished geologic literature and reports (see List of References).

Appendix A presents a discussion of our field investigation. Included in Appendix A is our boring log performed for this study and trench logs performed by Geocon Incorporated on the property during previous studies. We performed laboratory tests on soil samples obtained from the large diameter boring to evaluate pertinent physical properties for engineering analyses. The results of the laboratory testing are presented in Appendix B. Also included in Appendix B is laboratory test results from our previous study.

Site geologic conditions are depicted on Figure 2 (Geologic Map). The geologic contacts were plotted on a base map provided by Civil Sense, Inc. Geologic cross sections are provided on Figures 3 and 4.

The conclusions and recommendations presented herein are based on our analysis of the data obtained during the investigation, and our experience with similar soil and geologic conditions on this and adjacent properties.

2. SITE AND PROJECT DESCRIPTION

The irregularly shaped, approximately 15-acre site is located northwest of the Dennery Road and Regatta Lane intersection, east of I-805 in Chula Vista, California (see Vicinity Map, Figure 1). There are no existing structures on the site, however several remnant building foundations are present. Existing utilities at the site include 18- and 27-inch diameter sewer mains along the west and northern portions of the property, respectively, high-voltage overhead electrical lines traversing the southern portion of the site, and water lines and storm drain lines in the southeast corner of the property and a reclaimed water line along the eastern property boundary. We understand the sewer main on the west

property margin and the reclaimed water line on the eastern property margin will remain. The sewer main that crosses the northern portion of the property will be removed.

Site topography is relatively flat, sloping from south to north towards the Otay River channel. A north-facing natural slope, approximately 70 feet high is present along the south property boundary. Elevations across the site range between approximately 95 and 180 feet above Mean Sea Level (MSL; see *Geologic Map*, Figure 2).

A review of proposed grading plans by Civil Sense indicates proposed improvements will consist of 157 residential lots, a park, an underground stormwater management system, utilities, and street improvements. Entrance to the property will be from a driveway at the southeast corner of the property extending from Dennery Road. The proposed development includes cuts and fills up to 15 feet in sheet graded areas and cut and fill slopes at inclinations of 2:1 (horizontal:vertical) with heights up to 55 feet.

The locations and descriptions of the site and proposed development are based on our recent site reconnaissance, previous and recent field investigations, and our understanding of site development as shown on the grading plan prepared by Civil Sense. If project details vary significantly from those described, Geocon Incorporated should be contacted to review the changes and provide additional analyses and/or revisions to this report, if warranted.

3. SOIL AND GEOLOGIC CONDITIONS

Based on the results of the field investigation, the site is underlain by four surficial soil types and one formational unit, which are described below. Mapped geologic conditions are depicted on the *Geologic Map* (Figure 2, map pocket) and *Geologic Cross Sections* (Figures 3 and 4). Trench and boring logs are presented in Appendix A.

3.1 Undocumented Fill (Qudf)

We encountered undocumented fill in the trenches to depths of approximately 2 to 5 feet across the majority of the site, increasing to greater than 18 feet in the northeast portion of the site. The undocumented fill consists of very loose to moderately dense, sand with cobbles. Abundant debris including pieces of plastic, asphalt concrete, concrete curb, brick and wood were also encountered in the undocumented fill. The undocumented fill is compressible in its current state and will require complete removal and recompaction to support compacted fill and/or proposed site improvements.

3.2 Topsoil (Unmapped)

Topsoil covers the majority of the site and varies in thickness from 0.5 feet to 3 feet. The topsoil typically consists of loose to moderately dense, dry to moist, sand, cobble and clay. The topsoil is compressible and will require removal and recompaction to support compacted fill and/or proposed site improvements.

3.3 Alluvium (Qal)

Alluvium is present in a drainage located at the southeast corner of the property. Alluvium was also encountered in Trench T-20 beneath undocumented fill at the north end of the site. The alluvium consists of stiff, damp, dark brown, sandy clay with gravel. The alluvium is compressible and will require removal and recompaction to support compacted fill and/or proposed site improvements.

3.4 Colluvium (Qcol)

Colluvium is derived from weathering of the underlying bedrock materials at higher elevations and is deposited by gravity and sheet-flow on the side slopes and canyon sidewalls. The observed thickness of colluvium at the site was approximately 3 to 5 feet near trench T-6. The colluvium as encountered consists of moderately dense, olive brown, clayey sand with cobbles. The colluvium is compressible in its current state and will require removal and recompaction to support compacted fill and/or proposed site improvements.

3.5 Terrace Deposits (Qt)

Quaternary-age Terrace Deposits were observed underlying artificial fill, topsoil, and alluvium in the flatter portions of the site. The Terrace Deposits consist of moderately dense to very dense and firm to very stiff, clayey gravel, clayey to cobbly sand, and silty to cobbly clay. Terrace Deposits are suitable for support of compacted fill and/or structural loads.

3.6 Mission Valley Formation (Tmv)

Upper Eocene-age Mission Valley Formation was encountered in slopes along the southern portion of the site. The Mission Valley Formation is predominantly a marine sandstone unit consisting of reddish brown to tan, weak to friable, silty, fine- to medium-grained sandstone. The formation is typically moderately to well cemented but is usually rippable with heavy duty excavation equipment; however, localized cemented zones and concretions should be expected. The Mission Valley Formation is suitable for the support of the compacted fill and structural loads.

4. GROUNDWATER

We did not encounter groundwater or seepage during our recent or previous site investigations. However, it is not uncommon for shallow seepage conditions to develop where none previously existed when sites are irrigated or infiltration is implemented. Seepage is dependent on seasonal precipitation, irrigation, land use, among other factors, and varies as a result. Proper surface drainage will be important to future performance of the project. We expect the groundwater elevation at the site to be between 80 and 90 feet MSL. We do not anticipate encountering groundwater during construction of the proposed development.

5. GEOLOGIC HAZARDS

5.1 Faulting and Seismicity

A review of the referenced geologic materials and our knowledge of the general area indicates that the site is not underlain by active, potentially active, or inactive faults. An active fault is defined by the California Geological Survey (CGS) as a fault showing evidence for activity within the last 11,700 years. The site is not located within a State of California Earthquake Fault Zone.

The United States Geological Survey (USGS) has developed a program to evaluate the approximate location of faulting. The following figure shows the location of the existing faulting in the San Diego County and Southern California region. The faults are shown as solid, dashed and dotted traces representing well-constrained, moderately constrained and inferred faults, respectively. The fault line colors represent faults with ages less than 150 years (red), 15,000 years (orange), 130,000 years (green), 750,000 years (blue) and 1.6 million years (black).

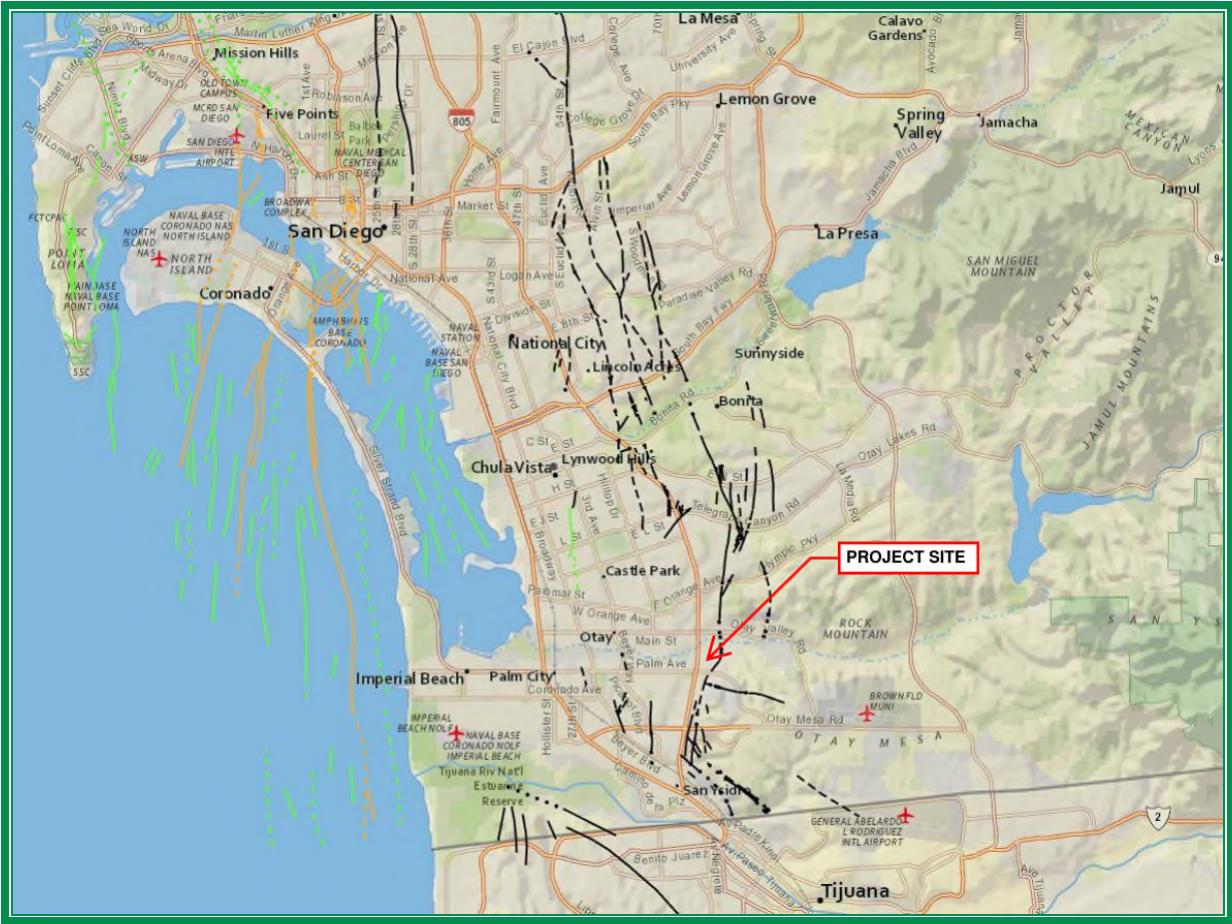

Faults in the San Diego Area

The San Diego County and Southern California region is seismically active. The following figure presents the occurrence of earthquakes with a magnitude greater than 2.5 from the period of 1900 through 2015 according to the Bay Area Earthquake Alliance website.

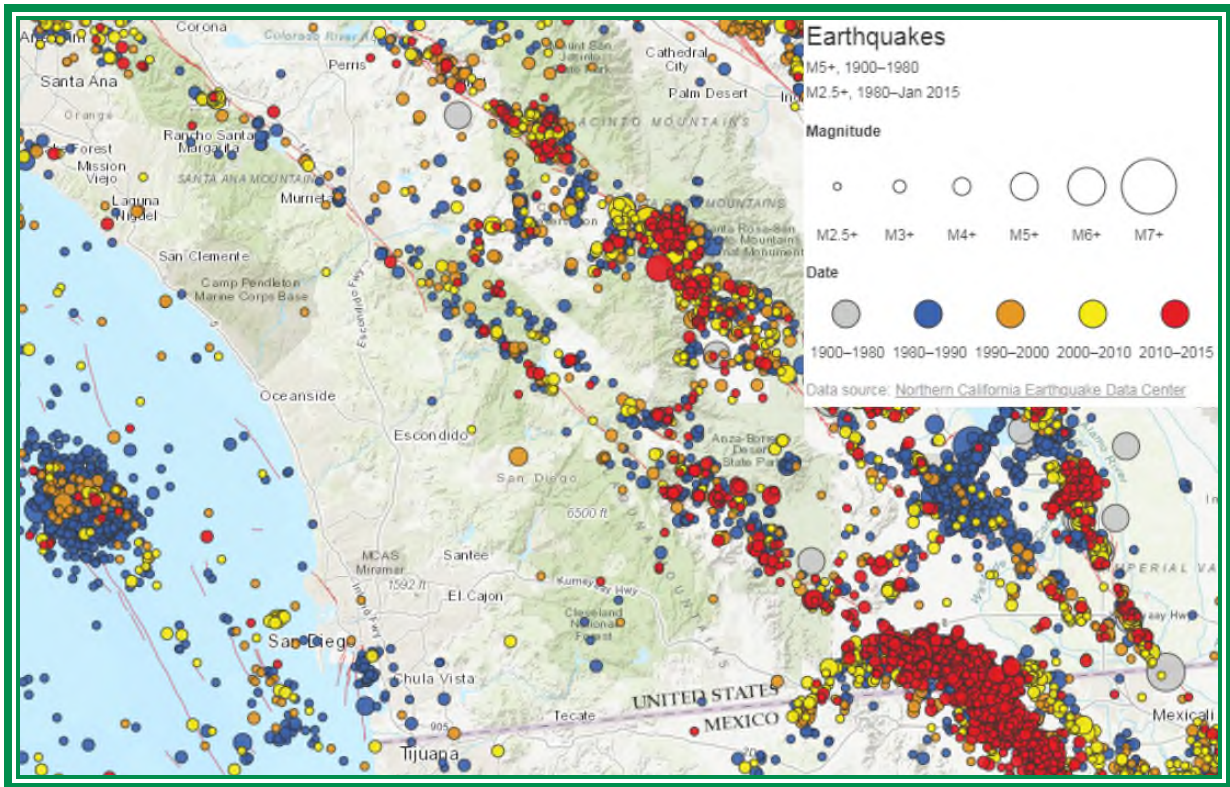

Earthquakes in Southern California

Considerations important in seismic design include the frequency and duration of motion and the soil conditions underlying the site. Seismic design of structures should be evaluated in accordance with the California Building Code (CBC) guidelines currently adopted by the local agency.

5.2 Ground Rupture

The risk associated with ground rupture hazard is very low due to the absence of active faults at the subject site.

5.3 Tsunamis and Seiches

The site is not located near the ocean or downstream of any large bodies of standing water. Therefore, the risk of tsunamis or seiches associated with the site is low.

5.4 Flooding

According to maps produced by the Federal Emergency Management Agency (FEMA), the majority of the site is zoned as “Zone X – Minimal Flood Hazard.” However, the limits of the 100- and 500-year flood zones are on or immediately adjacent to the north property boundary. Based on our review of FEMA flood maps, the risk of site flooding from channel overflow of the Otay River is low.

5.5 Liquefaction and Seismically Induced Settlement

Soil liquefaction occurs within relatively loose, cohesionless sand located below the water table that is subjected to ground accelerations from earthquakes. Due to the dense nature of the soils underlying the site, proposed grading, and the lack of permanent, shallow groundwater, there is a low risk of liquefaction occurring at the site.

5.6 Landslides

Based on our review of published geologic maps for the site vicinity, landslides are not mapped on the property or at a location that could impact the site. Based on our review of historical aerial photographs, landslide-related features are not discernable in the north-facing slope located near the south property boundary. However, landslides have been mapped east of the site in the Otay Formation, which overlies the Mission Valley Formation on the upthrown side of the La Nacion Fault zone.

Bedding attitudes recorded during downhole logging of boring LD-1 are similar to those recorded in areas surrounding the site. Steeper westerly dips ranging between 10 and 20 degrees were observed in the boring, compared to three to five degrees west shown on local geologic maps. Steeper dips are attributed to localized deformation resulting from movement on the La Nacion fault zone. The proposed cut slope shown on the site plan is oriented perpendicular to strike, therefore no significant out-of-slope dip component is anticipated. However, given the proximity of other landslides, we recommend cut slope mapping during grading.

5.7 Geologic Hazard Category

Review of the 2008 City of San Diego Seismic Safety Study, Geologic Hazards and Faults, Sheet 6, indicates the site is mapped as Geologic Hazard Categories 22 and 52. Category 22 is described as-Landslides – possible or conjectured. Category 52 is described as-Other Terrain, other level areas, gently sloping to steep terrain, favorable geologic structure, low risk.

6. CONCLUSIONS AND RECOMMENDATIONS

6.1 General

- 6.1.1 No soil or geologic conditions were observed that would preclude the development of the property as presently proposed provided that the recommendations of this report are followed.
- 6.1.2 The site is underlain by compressible surficial deposits consisting of undocumented fill, topsoil, colluvium, alluvium that generally range from 2 to 9 feet thick, but exceeds 18 feet thick in the northwest portion of the site. The surficial soils will require complete removal and recompaction.
- 6.1.3 Terrace deposits underlie the surficial deposits in the flatter areas of the site. The Tertiary-aged Mission Valley Formation is exposed in the north facing slope adjacent to the south property boundary. Terrace Deposits and the Mission Valley Formation are suitable for support of the planned project.
- 6.1.4 With the exception of possible strong seismic shaking, no significant geologic hazards were observed or are known to exist on the site that would adversely affect the site. No special seismic design considerations, other than those recommended herein, are required.
- 6.1.5 Groundwater was not encountered during our investigation. However, groundwater may be encountered during remedial grading on the north side of the property adjacent to the Otay River channel.
- 6.1.6 Based on our experience and prior laboratory testing, we expect the majority of on-site soils to possess a very low to medium expansion potential. We also expect the soils to have negligible sulfate exposure to concrete structures.
- 6.1.7 Cut slopes should be observed and mapped during grading by an engineering geologist to verify that the soil and geologic conditions do not differ significantly from those anticipated.
- 6.1.8 Provided the recommendations of this report are followed, it is our opinion that the proposed development will not destabilize or result in settlement of adjacent properties and City right-of-way.

6.2 Soil and Excavation Characteristics

- 6.2.1 In general, special shoring requirements may not be necessary if temporary excavations will be less than 4 feet in height. It is the responsibility of the contractor and their competent person to ensure all excavations, temporary slopes and trenches are properly constructed and maintained in accordance with applicable OSHA guidelines, in order to maintain safety and the stability of the excavations and adjacent improvements. These excavations should not be allowed to become saturated or to dry out. Surcharge loads should not be permitted to a distance equal to the height of the excavation from the top of the excavation. The top of the excavation should be a minimum of 15 feet from the edge of existing improvements. Excavations steeper than those recommended or closer than 15 feet from an existing surface improvement should be shored in accordance with applicable OSHA codes and regulations.
- 6.2.2 Excavation of existing undocumented fill and surficial deposits should be possible with moderate to heavy effort using conventional heavy-duty equipment. Excavation of the Mission Valley Formation may require very heavy effort with conventional heavy-duty grading equipment.
- 6.2.3 The soil encountered during our field investigations is considered to be both “non-expansive” (expansion index [EI] of 20 or less) and “expansive” (EI greater than 20) as defined by 2019 California Building Code (CBC) Section 1803.5.3. Table 6.2.1 presents soil classifications based on the expansion index. Based on prior laboratory test results, the majority of the soil encountered is expected to possess a “very low” to “medium” expansion potential. Samples of near pad grade soils should be collected after the completion of grading to evaluate expansion index.

**TABLE 6.2.1
EXPANSION CLASSIFICATION BASED ON EXPANSION INDEX**

Expansion Index (EI)	Expansion Classification	2019 CBC Expansion Classification
0 – 20	Very Low	Non-Expansive
21 – 50	Low	Expansive
51 – 90	Medium	
91 – 130	High	
Greater Than 130	Very High	

- 6.2.4 Results from prior laboratory testing indicate the on-site soils possess an “S0” sulfate exposure class to concrete structures as defined by 2019 CBC Section 1904 and ACI 318-08 Sections 4.2 and 4.3. Table 6.2.2 presents a summary of concrete requirements set forth by

2019 CBC Section 1904 and ACI 318. The presence of water-soluble sulfates is not a visually discernible characteristic; therefore, other soil samples from the site could yield different concentrations. Additionally, over time landscaping activities (i.e., addition of fertilizers and other soil nutrients) may affect the concentration. Samples of near pad grade soils should be collected to evaluate water-soluble sulfates after the completion of grading.

**TABLE 6.2.2
REQUIREMENTS FOR CONCRETE EXPOSED TO
SULFATE-CONTAINING SOLUTIONS**

Exposure Class	Water-Soluble Sulfate Percent by Weight	Cement Type	Maximum Water to Cement Ratio by Weight	Minimum Compressive Strength (psi)
S0	0.00-0.10	--	--	2,500
S1	0.10-0.20	II	0.50	4,000
S2	0.20-2.00	V	0.45	4,500
S3	> 2.00	V+Pozzolan or Slag	0.45	4,500

6.2.5 Geocon Incorporated does not practice in the field of corrosion engineering; therefore, further evaluation by a corrosion engineer may be needed to incorporate the necessary precautions to avoid premature corrosion of underground pipes and buried metal in direct contact with soil.

6.3 Grading Recommendations

6.3.1 All grading should be performed in accordance with the *Recommended Grading Specifications* contained in Appendix D. Where the recommendations of this section conflict with those of Appendix D, **the recommendations of this section take precedence**. All earthwork should be observed and all fill tested for proper compaction by Geocon Incorporated.

6.3.2 Prior to commencing grading, a preconstruction conference should be held at the site with the owner or developer, grading contractor, civil engineer, City of Chula Vista representatives, and geotechnical engineer in attendance. Special soil handling and/or the grading plans can be discussed at that time.

6.3.3 Site preparation should begin with the removal of deleterious material, debris, and vegetation. The depth of vegetation removal should be such that material exposed in cut areas or soil to be used as fill is relatively free of organic matter. Material generated during

stripping and/or site demolition should be exported from the site. Asphalt and concrete should not be mixed with the fill soil unless approved by the Geotechnical Engineer.

- 6.3.4 Abandoned foundations and buried utilities (if encountered) should be removed and the resultant depressions and/or trenches backfilled with properly compacted soil as part of the remedial grading.
- 6.3.5 All compressible soil deposits including undocumented fill, stockpiles, alluvium and colluvium within areas where structural improvements and/or structural fills are planned, should be removed to expose the underlying Terrace Deposits or Mission Valley Formation, prior to placing additional fill and/or structural loads. The actual extent of unsuitable soil removals will be evaluated in the field during grading by the geotechnical engineer and/or engineering geologist.
- 6.3.6 Based on the current grading plan, cut to fill transitions are expected within some of the lots. Lots with cut-fill transitions should be undercut at least 3 feet and replaced with properly compacted fill. The undercut should be sloped at a minimum of 1 percent toward the street or deeper fill area.
- 6.3.7 Removal of compressible surficial soils should extend beyond the toe of fill slopes a horizontal distance equal to the depth of the remedial removal (see Figure 5 for general information). The actual extent of remedial grading should be determined in the field by the geotechnical engineer or engineering geologist.
- 6.3.8 Prior to placing fill, the base of excavations and surface of previously placed fill and compacted fill should be scarified; moisture conditioned as necessary and compacted. Fill soils may then be placed and compacted in layers to the design finish grade elevations. In general, on-site soils are suitable for re-use as fill if free from vegetation, debris and other deleterious material. Layers of fill should be no thicker than will allow for adequate bonding and compaction. All fill, including scarified ground surfaces and backfill, should be compacted to at least 90 percent of laboratory maximum dry density as determined by ASTM D 1557 at or slightly above optimum moisture content. Overly wet materials will require drying and/or mixing with drier soils to facilitate proper compaction.
- 6.3.9 The upper 3 feet of fill on all lots and streets should be composed of properly compacted *very low* to *low* expansive soils. Highly expansive soils, if encountered, should be placed in deeper fill areas and properly compacted. *Very low* to *low* expansive soils are defined as those soils that have an Expansion Index of 50 or less. Boulders, concretions, concrete chunks greater than 12 inches in maximum dimension should not be placed within 5 feet of

finish grade or 3 feet from the deepest utility within streets. Specific recommendations for the placement of oversize rock is contained in the *Grading Specifications* contained in Appendix D.

- 6.3.10 Imported fill (if necessary) should consist of granular materials with a *very low* to *low* expansion potential (EI of 50 or less), be free of deleterious material or stones larger than 3 inches, and should be compacted as recommended herein. Geocon Incorporated should be notified of the import soil source and should be authorized to perform laboratory testing of import soil prior to its arrival at the site to evaluate its suitability as fill material.

6.4 Slopes

- 6.4.1 Slope stability analyses were performed for proposed cut slopes up to 55 feet high (2:1 gradient), the existing hillside slope (2.5:1 or flatter) that has a height up to approximately 120 feet and extends onto the property to the south, and proposed fill slopes up to 10 feet in height (2:1 gradient). The stability analyses were performed using simplified Janbu analysis. Our analyses utilized average drained direct shear strength parameters based on laboratory tests performed for this project and our experience with similar soils. The analyses indicate planned cut and fill slopes, and the existing native perimeter slope will have a calculated factors of safety in excess of 1.5 under static conditions for both deep-seated failure and shallow sloughing conditions. A summary of slope stability analyses is presented on Figures 6 through 9.
- 6.4.2 All cut slope excavations should be observed during grading by an engineering geologist to verify that soil and geologic conditions do not differ significantly from those anticipated.
- 6.4.3 The outer 15 feet (or a distance equal to the height of the slope, whichever is less) of fill slopes should be composed of properly compacted granular *soil* fill to reduce the potential for surficial sloughing. Granular “soil” fill is defined as a well-graded soil mix with less than 20 percent fines (silt and clay particles). Poorly graded soils with less than 5 percent fines should not be used in the slope zone due to high erosion potential. All slopes should be compacted by backrolling with a loaded sheepsfoot roller at vertical intervals not to exceed 4 feet and should be track-walked at the completion of each slope such that the fill soils are uniformly compacted to at least 90 percent relative compaction to the face of the finished sloped.
- 6.4.4 All slopes should be landscaped with drought-tolerant vegetation, having variable root depths and requiring minimal landscape irrigation. In addition, all slopes should be drained and properly maintained to reduce erosion.

6.5 Seismic Design Criteria (2019)

6.5.1 Table 6.5.1 summarizes site-specific design criteria obtained from the 2019 California Building Code (CBC; Based on the 2018 International Building Code [IBC] and ASCE 7-16), Chapter 16 Structural Design, Section 1613 Earthquake Loads. We used the computer program *U.S. Seismic Design Maps*, provided by the Structural Engineers Association of California (SEAOC) to calculate the seismic design parameters. The short spectral response uses a period of 0.2 second. We evaluated the Site Class based on the discussion in Section 1613.2.2 of the 2019 CBC and Table 20.3-1 of ASCE 7-16. Site Class C can be used for lots with fill thickness of 20 feet or less. Site Class D is applicable to lots with fill thicknesses greater than 20 feet. The majority of the site falls within Site Class C. A couple lots in the northwest corner might fall into Site Class D after completion of remedial grading. The values presented herein are for the risk-targeted maximum considered earthquake (MCE_R). Sites designated as Site Class D, E and F may require additional analyses if requested by the project structural engineer and client.

**TABLE 6.5.1
2019 CBC SEISMIC DESIGN PARAMETERS**

Parameter	Value		2019 CBC Reference
	C	D	
Site Class	C	D	Section 1613.2.2
MCE_R Ground Motion Spectral Response Acceleration – Class B (short), S_S	0.901g	0.901g	Figure 1613.2.1(1)
MCE_R Ground Motion Spectral Response Acceleration – Class B (1 sec), S_1	0.315g	0.315g	Figure 1613.2.1(2)
Site Coefficient, F_A	1.2	1.14	Table 1613.2.3(1)
Site Coefficient, F_V	1.5	1.985*	Table 1613.2.3(2)
Site Class Modified MCE_R Spectral Response Acceleration (short), S_{MS}	1.081g	1.027g	Section 1613.2.3 (Eqn 16-36)
Site Class Modified MCE_R Spectral Response Acceleration – (1 sec), S_{M1}	0.472g	0.625g*	Section 1613.2.3 (Eqn 16-37)
5% Damped Design Spectral Response Acceleration (short), S_{DS}	0.721g	0.684g	Section 1613.2.4 (Eqn 16-38)
5% Damped Design Spectral Response Acceleration (1 sec), S_{D1}	0.315g	0.417g*	Section 1613.2.4 (Eqn 16-39)

* Using the code-based values presented in this table, in lieu of a performing a ground motion hazard analysis, requires the exceptions outlined in ASCE 7-16 Section 11.4.8 be followed by the project structural engineer. Per Section 11.4.8 of ASCE/SEI 7-16, a ground motion hazard analysis should be performed for projects for Site Class “E” sites with S_s greater than or equal to 1.0g and for Site Class “D” and “E” sites with S_1 greater than 0.2g. Section 11.4.8 also provides exceptions which indicates that the ground motion hazard analysis may be waived provided the exceptions are followed.

6.5.2 Table 6.5.2 presents the mapped maximum considered geometric mean (MCE_G) seismic design parameters for projects located in Seismic Design Categories of D through F in accordance with ASCE 7-16.

**TABLE 6.5.2
ASCE 7-16 PEAK GROUND ACCELERATION**

Parameter	Value		ASCE 7-16 Reference
Site Class	C	D	
Mapped MCE_G Peak Ground Acceleration, PGA	0.396	0.396	Figure 22-7
Site Coefficient, F_{PGA}	1.2	1.204	Table 11.8-1
Site Class Modified MCE_G Peak Ground Acceleration, PGA_M	0.475	0.477g	Section 11.8.3 (Eqn 11.8-1)

6.5.3 Conformance to the criteria in Tables 6.5.1 and 6.5.2 for seismic design does not constitute any kind of guarantee or assurance that significant structural damage or ground failure will not occur if a large earthquake occurs. The primary goal of seismic design is to protect life, not to avoid all damage, since such design may be economically prohibitive.

6.5.4 The project structural engineer and architect should evaluate the appropriate Risk Category and Seismic Design Category for the planned structures. The values presented herein assume a Risk Category of II and resulting in a Seismic Design Category D. Table 6.5.3 presents a summary of the risk categories.

**TABLE 6.5.3
ASCE 7-16 RISK CATEGORIES**

Risk Category	Building Use	Examples
I	Low risk to Human Life at Failure	Barn, Storage Shelter
II	Nominal Risk to Human Life at Failure (Buildings Not Designated as I, III or IV)	Residential, Commercial and Industrial Buildings
III	Substantial Risk to Human Life at Failure	Theaters, Lecture Halls, Dining Halls, Schools, Prisons, Small Healthcare Facilities, Infrastructure Plants, Storage for Explosives/Toxins
IV	Essential Facilities	Hazardous Material Facilities, Hospitals, Fire and Rescue, Emergency Shelters, Police Stations, Power Stations, Aviation Control Facilities, National Defense, Water Storage

6.6 Foundations

6.6.1 The following foundation recommendations apply to one- to three story structures and are based on the building pads being underlain by properly compacted fill or native soils, and soil within 3 feet of finish grade consisting of *very low* to *medium* expansive soils (Expansion Index of 90 or less). The foundation recommendations have been separated into three categories dependent on the thickness and geometry of the underlying fill soils as well as the expansion index of the prevailing subgrade soils of a particular building pad (or lot). The foundation category criteria are presented in Table 6.6.1

**TABLE 6.6.1
FOUNDATION CATEGORY CRITERIA**

Foundation Category	Maximum Fill Thickness, T (feet)	Differential Fill Thickness, D (feet)	Expansion Index (EI)
I	$T < 20$	--	$EI \leq 50$
II	$20 \leq T < 50$	$10 \leq D < 20$	$50 < EI \leq 90$
III	$T \geq 50$	$D \geq 20$	$90 < EI \leq 130$

6.6.2 We will provide final foundation categories for each building or lot after completion of grading (finish pad grades have been achieved) and laboratory expansion testing of the finish grade soils is complete.

6.6.3 The proposed structures can be supported on a shallow foundation system founded in the compacted fill/formational materials. Foundations for the structure should consist of continuous strip footings and/or isolated spread footings. Table 6.6.2 presents minimum foundation and interior concrete slab design criteria for conventional foundation systems.

**TABLE 6.6.2
CONVENTIONAL FOUNDATION RECOMMENDATIONS BY CATEGORY**

Foundation Category	Minimum Footing Embedment Depth (inches)	Continuous Footing Reinforcement	Interior Slab Reinforcement
I	12	Two No. 4 bars, one top and one bottom	6 x 6 - 10/10 welded wire mesh at slab mid-point
II	18	Four No. 4 bars, two top and two bottom	No. 3 bars at 24 inches on center, both directions
III	24	Four No. 5 bars, two top and two bottom	No. 3 bars at 18 inches on center, both directions

6.6.4 Table 6.6.3 provides a summary of the foundation design recommendations.

**TABLE 6.6.3
SUMMARY OF FOUNDATION RECOMMENDATIONS**

Parameter	Value
Minimum Continuous Foundation Width	12 inches
Minimum Isolated Foundation Width	24 inches
Minimum Foundation Depth	See Table 6.6.2
Minimum Steel Reinforcement	See Table 6.6.2
Allowable Bearing Capacity	2,000 psf
Bearing Capacity Increase	500 psf per additional foot of footing depth
	300 psf per additional foot of footing width
Maximum Allowable Bearing Capacity	4,000 psf
Estimated Total Settlement	1 Inch
Estimated Differential Settlement	½ Inch in 40 Feet
Footing Size Used for Settlement	9-Foot Square
Design Expansion Index	50 or less

6.6.5 The foundations should be embedded in accordance with the recommendations herein and the Wall/Column Footing Dimension Detail below. The embedment depths should be measured from the lowest adjacent pad grade for both interior and exterior footings. Footings should be deepened such that the bottom outside edge of the footing is at least 7 feet horizontally from the face of the slope (unless designed with a post-tensioned foundation system as discussed herein).

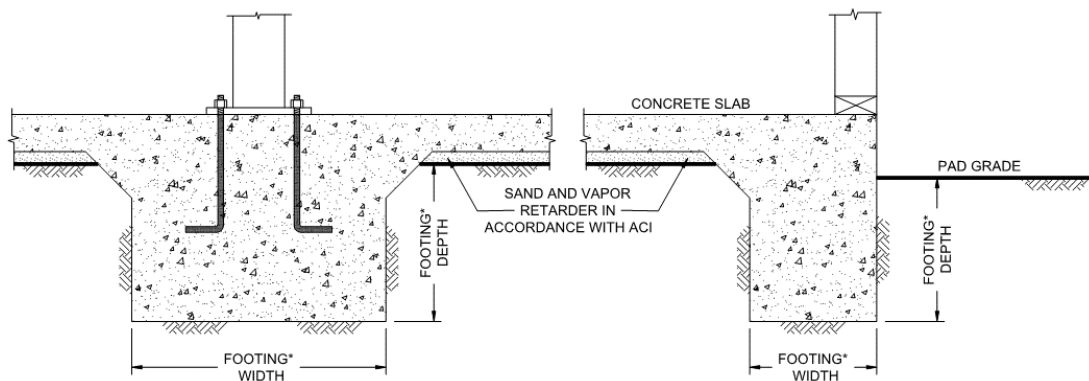

Wall/Column Footing Dimension Detail

6.6.6 The bearing capacity values presented herein are for dead plus live loads and may be increased by one-third when considering transient loads due to wind or seismic forces.

- 6.6.7 Under the recommended allowable bearing pressures provided, we expect settlement as a result of building loading to be less than 1-inch total and ½-inch differential over a span of 40 feet.
- 6.6.8 Conventional building concrete slabs-on-grade should be at least 4 inches thick for Foundation Categories I and II and 5 inches thick for Foundation Category III.
- 6.6.9 A vapor retarder should underlie slabs that may receive moisture-sensitive floor coverings or may be used to store moisture-sensitive materials. The vapor retarder design should be consistent with the guidelines presented in the American Concrete Institute's (ACI) *Guide for Concrete Slabs that Receive Moisture-Sensitive Flooring Materials* (ACI 302.2R-06). In addition, the membrane should be installed in accordance with manufacturer's recommendations and ASTM requirements and in a manner that prevents puncture. The project architect or developer should specify the type of vapor retarder used based on the type of floor covering that will be installed and if the structure will possess a humidity controlled environment.
- 6.6.10 The project foundation engineer, architect, and/or developer should determine the thickness of bedding sand below the slab. However, Geocon should be contacted to provide recommendations if the bedding sand is thicker than 6 inches.
- 6.6.11 The foundation design engineer should provide appropriate concrete mix design criteria and curing measures to assure proper curing of the slab by reducing the potential for rapid moisture loss and subsequent cracking and/or slab curl. We suggest that the foundation design engineer present the concrete mix design and proper curing methods on the foundation plans. It is critical that the foundation contractor understands and follows the specifications presented on the foundation plans.
- 6.6.12 As an alternative to the conventional foundation recommendations, consideration should be given to the use of post-tensioned concrete slab and foundation systems for the support of the proposed structures. The post-tensioned systems should be designed by a structural engineer experienced in post-tensioned slab design and design criteria of the Post-Tensioning Institute (PTI) DC10.5 *Standard Requirements for Design and Analysis of Shallow Post-Tensioned Concrete Foundations on Expansive Soils* or *WRI/CRSI Design of Slab-on-Ground Foundations*, as required by the 2019 California Building Code (CBC Section 1808.6.2). Although this procedure was developed for expansive soil conditions, we understand it can also be used to reduce the potential for foundation distress due to differential fill settlement. The post-tensioned design should incorporate the geotechnical

parameters presented on Table 6.6.4. The parameters presented in Table 6.6.4 are based on the guidelines presented in the PTI, DC10.5 design manual.

**TABLE 6.6.4
POST-TENSIONED FOUNDATION SYSTEM DESIGN PARAMETERS**

Post-Tensioning Institute (PTI), Third Edition Design Parameters	Foundation Category		
	I	II	III
Thornthwaite Index	-20	-20	-20
Equilibrium Suction	3.9	3.9	3.9
Edge Lift Moisture Variation Distance, e_M (feet)	5.3	5.1	4.9
Edge Lift, y_M (inches)	0.61	1.10	1.58
Center Lift Moisture Variation Distance, e_M (feet)	9.0	9.0	9.0
Center Lift, y_M (inches)	0.30	0.47	0.66

6.6.13 The foundations for the post-tensioned slabs should be embedded in accordance with the recommendations of the structural engineer. For moisture cut-off, we recommend the perimeter foundation have an embedment depth of at least 12 inches. If a post-tensioned mat foundation system is planned, the slab should possess a thickened edge with a minimum width of 12 inches that extends at least 12 inches below the clean sand layer.

6.6.14 If the structural engineer proposes a post-tensioned foundation design method other than PTI, DC 10.5:

- The deflection criteria presented in Table 6.6.4 are still applicable.
- Interior stiffener beams should be used for Foundation Categories II and III.
- The width of the perimeter foundations should be at least 12 inches.
- The perimeter footing embedment depths should be at least 12 inches, 18 inches and 24 inches for foundation categories I, II, and III, respectively. The embedment depths should be measured from the lowest adjacent pad grade.

6.6.15 Foundation systems for the lots that possess a foundation Category I and a “very low” expansion potential (expansion index of 20 or less) can be designed using the method described in Section 1808 of the 2019 CBC. If post-tensioned foundations are planned, an alternative, commonly accepted design method (other than PTI) can be used. However, the post-tensioned foundation system should be designed with a total and differential deflection of 1 inch. Geocon Incorporated should be contacted to review the plans and provide additional information, if necessary.

- 6.6.16 If an alternate design method is contemplated, Geocon Incorporated should be contacted to evaluate if additional expansion index testing should be performed to identify the lots that possess a “very low” expansion potential (expansion index of 20 or less).
- 6.6.17 Our experience indicates post-tensioned slabs are susceptible to excessive edge lift, regardless of the underlying soil conditions. Placing reinforcing steel at the bottom of the perimeter footings and the interior stiffener beams may mitigate this potential. Current PTI design procedures primarily address the potential center lift of slabs but, because of the placement of the reinforcing tendons in the top of the slab, the resulting eccentricity after tensioning reduces the ability of the system to mitigate edge lift. The structural engineer should design the foundation system to reduce the potential of edge lift occurring for the proposed structures.
- 6.6.18 During the construction of the post-tension foundation system, the concrete should be placed monolithically. Under no circumstances should cold joints form between the footings/grade beams and the slab during the construction of the post-tension foundation system unless designed by the project structural engineer.
- 6.6.19 Isolated footings outside of the slab area, if present, should have the minimum embedment depth and width recommended for conventional foundations for a particular Foundation Category. The use of isolated footings, which are located beyond the perimeter of the building and support structural elements connected to the building, are not recommended for Category III. Where this condition cannot be avoided, the isolated footings should be connected to the building foundation system with grade beams. In addition, consideration should be given to connecting patio slabs, which exceed 5 feet in width, to the building foundation to reduce the potential for future separation to occur.
- 6.6.20 Interior stiffening beams should be incorporated into the design of the foundation system in accordance with the PTI design procedures.
- 6.6.21 Special subgrade presaturation is not deemed necessary prior to placing concrete; however, the exposed foundation and slab subgrade soil should be moisture conditioned, as necessary, to maintain a moist condition as would be expected in any such concrete placement.
- 6.6.22 Where buildings or other improvements are planned near the top of a slope steeper than 3:1 (horizontal:vertical), special foundations and/or design considerations are recommended due to the tendency for lateral soil movement to occur.

- For fill slopes less than 20 feet high or cut slopes regardless of height, footings should be deepened such that the bottom outside edge of the footing is at least 7 feet horizontally from the face of the slope.
- For fill slopes greater than 20 feet high, foundations should be extended to a depth where the minimum horizontal distance is equal to $H/3$ (where H equals the vertical distance from the top of the fill slope to the base of the fill soil) with a minimum of 7 feet but need not exceed 40 feet. The horizontal distance is measured from the outer, deepest edge of the footing to the face of the slope. A post-tensioned slab and foundation system or mat foundation system can be used to help reduce potential foundation distress associated with slope creep and lateral fill extension. Specific design parameters or recommendations for either of these alternatives can be provided once the building location and fill slope geometry have been determined.
- If swimming pools are planned, Geocon Incorporated should be contacted for a review of specific site conditions.
- Swimming pools located within 7 feet of the top of cut or fill slopes are not recommended. Where such a condition cannot be avoided, the portion of the swimming pool wall within 7 feet of the slope face be designed assuming that the adjacent soil provides no lateral support. This recommendation applies to fill slopes up to 30 feet in height, and cut slopes regardless of height. For swimming pools located near the top of fill slopes greater than 30 feet in height, additional recommendations may be required and Geocon Incorporated should be contacted for a review of specific site conditions.
- Although other improvements that are relatively rigid or brittle, such as concrete flatwork or masonry walls, may experience some distress if located near the top of a slope, it is generally not economical to mitigate this potential. It may be possible, however, to incorporate design measures that would permit some lateral soil movement without causing extensive distress. Geocon Incorporated should be consulted for specific recommendations.

6.6.23 The recommendations of this report are intended to reduce the potential for cracking of slabs due to expansive soil (if present), differential settlement of existing soil or soil with varying thicknesses. However, even with the incorporation of the recommendations presented herein, foundations, stucco walls, and slabs-on-grade placed on such conditions may still exhibit some cracking due to soil movement and/or shrinkage. The occurrence of concrete shrinkage cracks is independent of the supporting soil characteristics. The occurrence may be reduced and/or controlled by: limiting the slump of the concrete, proper concrete placement and curing, and by the placement of crack control joints at periodic intervals, in particular, where re-entrant slab corners occur.

6.6.24 Geocon Incorporated should be consulted to provide additional design parameters as required by the structural engineer.

6.7 Conventional Retaining Wall Recommendations

6.7.1 Retaining walls should be designed using the values presented in Table 6.7.1. Soil with an expansion index (EI) of greater than 50 should not be used as backfill material behind retaining walls.

**TABLE 6.7.1
RETAINING WALL DESIGN RECOMMENDATIONS**

Parameter	Value	
	EI _≤ 50	EI _≤ 90
Active Soil Pressure, A (Fluid Density, Level Backfill)	35 pcf	40 pcf
Active Soil Pressure, A (Fluid Density, 2:1 Sloping Backfill)	45 psf	55 psf
Seismic Pressure, S	15H psf	
At-Rest/Restrained Walls Additional Uniform Pressure (0 to 8 Feet High)	7H psf	
At-Rest/Restrained Walls Additional Uniform Pressure (8+ Feet High)	13H psf	
Expected Expansion Index for the Subject Property	EI _≤ 50	

H equals the height of the retaining portion of the wall

6.7.2 The project retaining walls should be designed as shown in the Retaining Wall Loading Diagram.

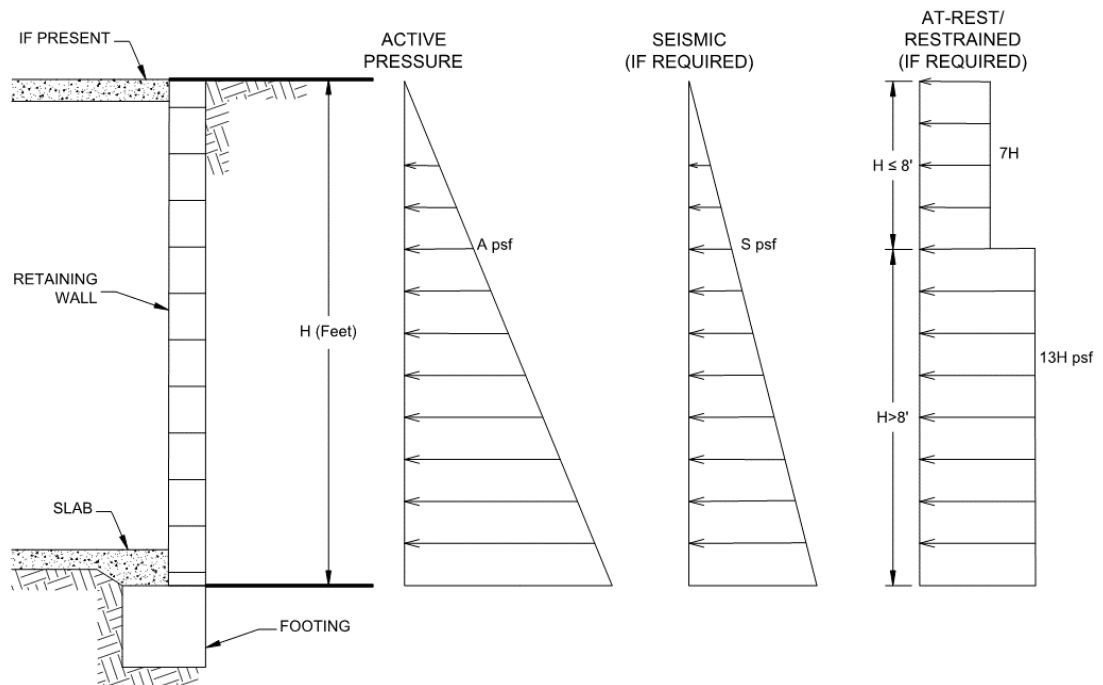

Retaining Wall Loading Diagram

- 6.7.3 Unrestrained walls are those that are allowed to rotate more than $0.001H$ (where H equals the height of the retaining portion of the wall) at the top of the wall. Where walls are restrained from movement at the top (at-rest condition), an additional uniform pressure of $7H$ psf should be added to the active soil pressure for walls 8 feet or less. For walls greater than 8 feet tall, an additional uniform pressure of $13H$ psf should be applied to the wall starting at 8 feet from the top of the wall to the base of the wall. For retaining walls subject to vehicular loads within a horizontal distance equal to two-thirds the wall height, a surcharge equivalent to 2 feet of fill soil should be added.
- 6.7.4 The structural engineer should determine the Seismic Design Category for the project in accordance with Section 1613.2.5 of the 2019 CBC or Section 11.6 of ASCE 7-16. For structures assigned to Seismic Design Category of D, E, or F, retaining walls that support more than 6 feet of backfill should be designed with seismic lateral pressure in accordance with Section 1803.5.12 of the 2019 CBC. The seismic load is dependent on the retained height where H is the height of the wall, in feet, and the calculated loads result in pounds per square foot (psf) exerted at the base of the wall and zero at the top of the wall. A seismic load of $17H$ psf should be used for design. We used the peak ground acceleration adjusted for Site Class effects, PGA_M , of $0.477g$ calculated from ASCE 7-16 Section 11.8.3 and applied a pseudo-static coefficient of 0.3.
- 6.7.5 Retaining walls should be designed to ensure stability against overturning sliding, and excessive foundation pressure. Where a keyway is extended below the wall base with the intent to engage passive pressure and enhance sliding stability, it is not necessary to consider active pressure on the keyway.
- 6.7.6 Drainage openings through the base of the wall (weep holes) should not be used where the seepage could be a nuisance or otherwise adversely affect the property adjacent to the base of the wall. The recommendations herein assume a properly compacted granular (EI of 50 or less) free-draining backfill material with no hydrostatic forces or imposed surcharge load. The retaining wall should be properly drained as shown in the Typical Retaining Wall Drainage Detail. If conditions different than those described are expected, or if specific drainage details are desired, Geocon Incorporated should be contacted for additional recommendations.

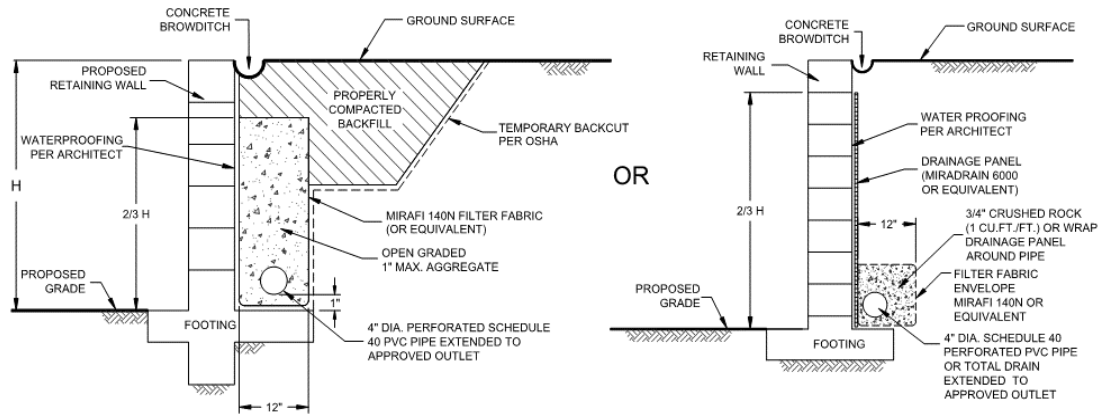

Typical Retaining Wall Drainage Detail

6.7.7 The retaining walls may be designed using either the active and restrained (at-rest) loading condition or the active and seismic loading condition as suggested by the structural engineer. Typically, it appears the design of the restrained condition for retaining wall loading may be adequate for the seismic design of the retaining walls. However, the active earth pressure combined with the seismic design load should be reviewed and also considered in the design of the retaining walls.

6.7.8 In general, wall foundations having should be designed in accordance with Table 6.7.2. The proximity of the foundation to the top of a slope steeper than 3:1 could impact the allowable soil bearing pressure. Therefore, retaining wall foundations should be deepened such that the bottom outside edge of the footing is at least 7 feet horizontally from the face of the slope.

**TABLE 6.7.2
SUMMARY OF RETAINING WALL FOUNDATION RECOMMENDATIONS**

Parameter	Value
Minimum Retaining Wall Foundation Width	12 inches
Minimum Retaining Wall Foundation Depth	12 Inches
Minimum Steel Reinforcement	Per Structural Engineer
Bearing Capacity	2,000 psf
Bearing Capacity Increase	500 psf per additional foot of footing depth
	300 psf per additional foot of footing width
Maximum Bearing Capacity	4,000 psf
Estimated Total Settlement	1 Inch
Estimated Differential Settlement	½ Inch in 40 Feet

- 6.7.9 The recommendations presented herein are generally applicable to the design of rigid concrete or masonry retaining walls. In the event that other types of walls (such as mechanically stabilized earth [MSE] walls, soil nail walls, or soldier pile walls) are planned, Geocon Incorporated should be consulted for additional recommendations.
- 6.7.10 Unrestrained walls will move laterally when backfilled and loading is applied. The amount of lateral deflection is dependent on the wall height, the type of soil used for backfill, and loads acting on the wall. The retaining walls and improvements above the retaining walls should be designed to incorporate an appropriate amount of lateral deflection as determined by the structural engineer.
- 6.7.11 Soil contemplated for use as retaining wall backfill, including import materials, should be identified in the field prior to backfill. At that time, Geocon Incorporated should obtain samples for laboratory testing to evaluate its suitability. Modified lateral earth pressures may be necessary if the backfill soil does not meet the required expansion index or shear strength. City or regional standard wall designs, if used, are based on a specific active lateral earth pressure and/or soil friction angle. In this regard, on-site soil to be used as backfill may or may not meet the values for standard wall designs. Geocon Incorporated should be consulted to assess the suitability of the on-site soil for use as wall backfill if standard wall designs will be used.

6.8 Lateral Loading

- 6.8.1 Table 6.8 should be used to help design the proposed structures and improvements to resist lateral loads for the design of footings or shear keys. The allowable passive pressure assumes a horizontal surface extending at least 5 feet, or three times the surface generating the passive pressure, whichever is greater. The upper 12 inches of material in areas not protected by floor slabs or pavement should not be included in design for passive resistance. Where walls are planned adjacent to and/or on descending slopes, a passive pressure of 150 pcf should be used in design.

**TABLE 6.8
SUMMARY OF LATERAL LOAD DESIGN RECOMMENDATIONS**

Parameter	Value
Passive Pressure Fluid Density	300 pcf
Passive Pressure Fluid Density Adjacent to and/or on Descending Slopes	150 pcf
Coefficient of Friction (Concrete and Soil)	0.35
Coefficient of Friction (Along Vapor Barrier)	0.2 to 0.25*

* Per manufacturer's recommendations.

6.8.2 The passive and frictional resistant loads can be combined for design purposes. The lateral passive pressures may be increased by one-third when considering transient loads due to wind or seismic forces.

6.9 Preliminary Pavement Recommendations

6.9.1 Preliminary pavement recommendations for the streets and parking areas are provided below. The final pavement sections should be based on the R-Value of the subgrade soil encountered at final subgrade elevation. For pavement design we used a laboratory R-Value of 10. Preliminary flexible pavement sections are presented in 6.9.1. We calculated the flexible pavement sections in general conformance with the Caltrans Method of Flexible Pavement Design (Highway Design Manual, Section 608.4) using estimated Traffic Indices (TI) in general accordance with City of Chula Vista guidelines (the City requires that private streets be designed in general accordance with City standards). The project civil engineer or traffic engineer should determine the appropriate Traffic Index (TI) or traffic loading expected on the project for the various pavement areas that will be constructed.

**TABLE 6.9.1
PRELIMINARY ASPHALT CONCRETE PAVEMENT SECTIONS**

Location	Minimum Traffic Index	Assumed Subgrade R-Value	Asphalt Concrete (inches)	Class 2 Aggregate Base (inches)
Residential Cul-De-Sac	5.0	10	3	9
Residential	6.0	10	3	12.5

6.9.2 Asphalt concrete should conform to Section 203-6 of the *Standard Specifications for Public Works Construction* (Green Book). Cement treated base should conform to Greenbook Section 301-3.3. Class 2 aggregate base materials should conform to Section 26-1.02B of the *Standard Specifications of the State of California, Department of Transportation* (Caltrans).

6.9.3 Prior to placing base material, the subgrade should be scarified, moisture conditioned and recompacted to a minimum of 95 percent relative compaction. The depth of compaction should be at least 12 inches. The base material should be compacted to at least 95 percent relative compaction. Asphalt concrete should be compacted to a density of at least 95 percent of the laboratory Hveem density in accordance with ASTM D 2726.

6.9.4 A rigid Portland Cement concrete (PCC) pavement section should be placed in driveway entrance aprons. The concrete pad for trash truck areas should be large enough such that the

truck wheels will be positioned on the concrete during loading. We calculated the rigid pavement section in general conformance with the procedure recommended by the American Concrete Institute report ACI 330R-08 Guide for Design and Construction of Concrete Parking Lots using the parameters presented in Table 6.9.2.

**TABLE 6.9.2
PRELIMINARY RIGID PAVEMENT DESIGN PARAMETERS**

Design Parameter	Design Value
Modulus of subgrade reaction, k	50 pci
Modulus of rupture for concrete, M_R	500 psi
Traffic Category, TC	A-1 and B
Average daily truck traffic, ADTT	1 and 25

6.9.5 Based on the criteria presented herein, the PCC pavement sections should have a minimum thickness as presented in Table 6.9.3.

**TABLE 6.9.3
PRELIMINARY RIGID PAVEMENT RECOMMENDATIONS**

Location	Portland Cement Concrete (inches)
Automobile Areas (TC=A-1, ADTT = 1)	5.5
Heavy Truck and Fire Lane Areas (TC=C, ADTT = 100)	7.0

6.9.6 The PCC pavement should be placed over subgrade soil that is compacted to a dry density of at least 95 percent of the laboratory maximum dry density near to slightly above optimum moisture content. For single-family residential lot driveways, 90 percent of the laboratory maximum dry density near to slightly above optimum moisture content is acceptable. This pavement section is based on a minimum concrete compressive strength of approximately 3,200 psi (pounds per square inch).

6.9.7 A thickened edge or integral curb should be constructed on the outside of concrete slabs subjected to wheel loads. The thickened edge should be 1.2 times the slab thickness or a minimum thickness of 2 inches, whichever results in a thicker edge, at the slab edge and taper back to the recommended slab thickness 3 feet behind the face of the slab (e.g., a 7-inch-thick slab would have a 9-inch-thick edge). Reinforcing steel will not be necessary within the concrete for geotechnical purposes with the exception of loading docks, trash bin enclosures, and dowels at construction joints as discussed below.

- 6.9.8 To control the location and spread of concrete shrinkage cracks, crack-control joints (weakened plane joints) should be included in the design of the concrete pavement slab. Crack-control joints should not exceed 30 times the slab thickness with a maximum spacing of 15 feet (e.g., a 7-inch-thick slab would have a 15-foot spacing pattern) and should be sealed with an appropriate sealant to prevent the migration of water through the control joint to the subgrade materials. The depth of the crack-control joints should be determined by the referenced ACI report.
- 6.9.9 To provide load transfer between adjacent pavement slab sections, a trapezoidal-keyed construction joint should be installed. As an alternative to the keyed joint, dowelling is recommended between construction joints. As discussed in the referenced ACI guide, dowels should consist of smooth, 7/8-inch-diameter reinforcing steel 14 inches long embedded a minimum of 6 inches into the slab on either side of the construction joint. Dowels should be located at the midpoint of the slab, spaced at 12 inches on center and lubricated to allow joint movement while still transferring loads. The project structural engineer may provide alternative recommendations for load transfer.
- 6.9.10 The performance of pavement is highly dependent on providing positive surface drainage away from the edge of the pavement. Ponding of water on or adjacent to the pavement will likely result in pavement distress and subgrade failure. Drainage from landscaped areas should be directed to controlled drainage structures. Landscape areas adjacent to the edge of asphalt pavements are not recommended due to the potential for surface or irrigation water to infiltrate the underlying permeable aggregate base and cause distress. Where such a condition cannot be avoided, consideration should be given to incorporating measures that will significantly reduce the potential for subsurface water migration into the aggregate base. If planter islands are planned, the perimeter curb should extend at least 6 inches below the level of the base materials.

6.10 Exterior Concrete Flatwork

- 6.10.1 Exterior concrete flatwork not subject to vehicular traffic should be constructed in accordance with the recommendations presented in Table 6.10. The recommended steel reinforcement would help reduce the potential for cracking.

TABLE 6.10
MINIMUM CONCRETE FLATWORK RECOMMENDATIONS

Expansion Index, EI	Minimum Steel Reinforcement* Options	Minimum Thickness
EI ≤ 90	6x6-W2.9/W2.9 (6x6-6/6) welded wire mesh	4 Inches
	No. 3 Bars 18 inches on center, Both Directions	
EI ≤ 130	4x4-W4.0/W4.0 (4x4-4/4) welded wire mesh	
	No. 4 Bars 12 inches on center, Both Directions	

* In excess of 8 feet square.

- 6.10.2 Even with the incorporation of the recommendations of this report, the exterior concrete flatwork has a potential to experience some uplift due to expansive soil beneath grade. The steel reinforcement should overlap continuously in flatwork to reduce the potential for vertical offsets within flatwork. Additionally, flatwork should be structurally connected to the curbs, where possible, to reduce the potential for offsets between the curbs and the flatwork.
- 6.10.3 Concrete flatwork should be provided with crack control joints to reduce and/or control shrinkage cracking. Crack control spacing should be determined by the project structural engineer based upon the slab thickness and intended usage. Criteria of the American Concrete Institute (ACI) should be taken into consideration when establishing crack control spacing. Subgrade soil for exterior slabs not subjected to vehicle loads should be compacted in accordance with criteria presented in the grading section prior to concrete placement. Subgrade soil should be properly compacted, and the moisture content of subgrade soil should be verified prior to placing concrete. Base materials will not be required below concrete improvements.
- 6.10.4 The recommendations presented herein are intended to reduce the potential for cracking of exterior slabs as a result of differential movement. However, even with the incorporation of the recommendations presented herein, slabs-on-grade will still crack. The occurrence of concrete shrinkage cracks is independent of the soil supporting characteristics. Their occurrence may be reduced and/or controlled by limiting the slump of the concrete, the use of crack control joints and proper concrete placement and curing. Crack control joints should be spaced at intervals no greater than 12 feet. Literature provided by the Portland Concrete Association (PCA) and American Concrete Institute (ACI) present recommendations for proper concrete mix, construction, and curing practices, and should be incorporated into project construction.

6.11 Slope Maintenance

- 6.11.1 Slopes that are steeper than 3:1 (horizontal:vertical) may, under conditions which are both difficult to prevent and predict, be susceptible to near surface (surficial) slope instability. The instability is typically limited to the outer three feet of a portion of the slope and usually does not directly impact the improvements on the pad areas above or below the slope. The occurrence of surficial instability is more prevalent on fill slopes and is generally preceded by a period of heavy rainfall, excessive irrigation, or the migration of subsurface seepage. The disturbance and/or loosening of the surficial soils, as might result from root growth, soil expansion, or excavation for irrigation lines and slope planting, may also be a significant contributing factor to surficial instability. It is, therefore, recommended that, to the maximum extent practical: (a) disturbed/loosened surficial soils be either removed or properly recompacted, (b) irrigation systems be periodically inspected and maintained to eliminate leaks and excessive irrigation, and (c) surface drains on and adjacent to slopes be periodically maintained to preclude ponding or erosion. Although the incorporation of the above recommendations should reduce the potential for surficial slope instability, it will not eliminate the possibility, and, therefore, it may be necessary to rebuild or repair a portion of the project's slopes in the future.

6.12 Storm Water Management

- 6.12.1 If storm water management devices are not properly designed and constructed, there is a risk for distress to improvements and property located hydrologically down gradient or adjacent to these devices. Factors such as the amount of water being detained, its residence time, and soil permeability have an important effect on seepage transmission and the potential adverse impacts that may occur if the storm water management features are not properly designed and constructed. We have not performed a hydrogeological study at the site. If infiltration of storm water runoff into the subsurface occurs, downstream improvements may be subjected to seeps, springs, slope instability, raised groundwater, movement of foundations and slabs, or other undesirable impacts as a result of water infiltration.
- 6.12.2 We performed an infiltration study on the property. A summary of our study and storm water management recommendations are provided in Appendix C. Based on the results of our study, full and partial infiltration is considered infeasible due to the presence of undocumented fills, low infiltration characteristics, and existing nearby utilities. Basins should utilize a liner to prevent infiltration from causing adverse settlement, migrating to adjacent slopes, utilities, and foundations.

6.13 Site Drainage and Moisture Protection

- 6.13.1 Adequate site drainage is critical to reduce the potential for differential soil movement, erosion and subsurface seepage. Under no circumstances should water be allowed to pond adjacent to footings. The site should be graded and maintained such that surface drainage is directed away from structures in accordance with 2019 CBC 1803.3 or other applicable standards. In addition, surface drainage should be directed away from the top of slopes into swales or other controlled drainage devices. Roof and pavement drainage should be directed into conduits that carry runoff away from the proposed structure.
- 6.13.2 In the case of basement walls or building walls retaining landscaping areas, a water-proofing system should be used on the wall and joints, and a Miradrain drainage panel (or similar) should be placed over the waterproofing. The project architect or civil engineer should provide detailed specifications on the plans for all waterproofing and drainage.
- 6.13.3 Underground utilities should be leak free. Utility and irrigation lines should be checked periodically for leaks, and detected leaks should be repaired promptly. Detrimental soil movement could occur if water is allowed to infiltrate the soil for prolonged periods of time.
- 6.13.4 Landscaping planters adjacent to paved areas are not recommended due to the potential for surface or irrigation water to infiltrate the pavement's subgrade and base course. We recommend that subdrains to collect excess irrigation water and transmit it to drainage structures, or impervious above-grade planter boxes be used. In addition, where landscaping is planned adjacent to the pavement, we recommend construction of a cutoff wall along the edge of the pavement that extends at least 6 inches below the bottom of the base material.

6.14 Grading and Foundation Plan Review

- 6.14.1 Geocon Incorporated should review the grading plans and foundation plans for the project prior to final design submittal to evaluate whether additional analyses and/or recommendations are required.

LIMITATIONS AND UNIFORMITY OF CONDITIONS

1. The firm that performed the geotechnical investigation for the project should be retained to provide testing and observation services during construction to provide continuity of geotechnical interpretation and to check that the recommendations presented for geotechnical aspects of site development are incorporated during site grading, construction of improvements, and excavation of foundations. If another geotechnical firm is selected to perform the testing and observation services during construction operations, that firm should prepare a letter indicating their intent to assume the responsibilities of project geotechnical engineer of record. A copy of the letter should be provided to the regulatory agency for their records. In addition, that firm should provide revised recommendations concerning the geotechnical aspects of the proposed development, or a written acknowledgement of their concurrence with the recommendations presented in our report. They should also perform additional analyses deemed necessary to assume the role of Geotechnical Engineer of Record.
2. The recommendations of this report pertain only to the site investigated and are based upon the assumption that the soil conditions do not deviate from those disclosed in the investigation. If any variations or undesirable conditions are encountered during construction, or if the proposed construction will differ from that anticipated herein, Geocon Incorporated should be notified so that supplemental recommendations can be given. The evaluation or identification of the potential presence of hazardous or corrosive materials was not part of the scope of services provided by Geocon Incorporated.
3. This report is issued with the understanding that it is the responsibility of the owner or his representative to ensure that the information and recommendations contained herein are brought to the attention of the architect and engineer for the project and incorporated into the plans, and the necessary steps are taken to see that the contractor and subcontractors carry out such recommendations in the field.
4. The findings of this report are valid as of the present date. However, changes in the conditions of a property can occur with the passage of time, whether they be due to natural processes or the works of man on this or adjacent properties. In addition, changes in applicable or appropriate standards may occur, whether they result from legislation or the broadening of knowledge. Accordingly, the findings of this report may be invalidated wholly or partially by changes outside our control. Therefore, this report is subject to review and should not be relied upon after a period of three years.

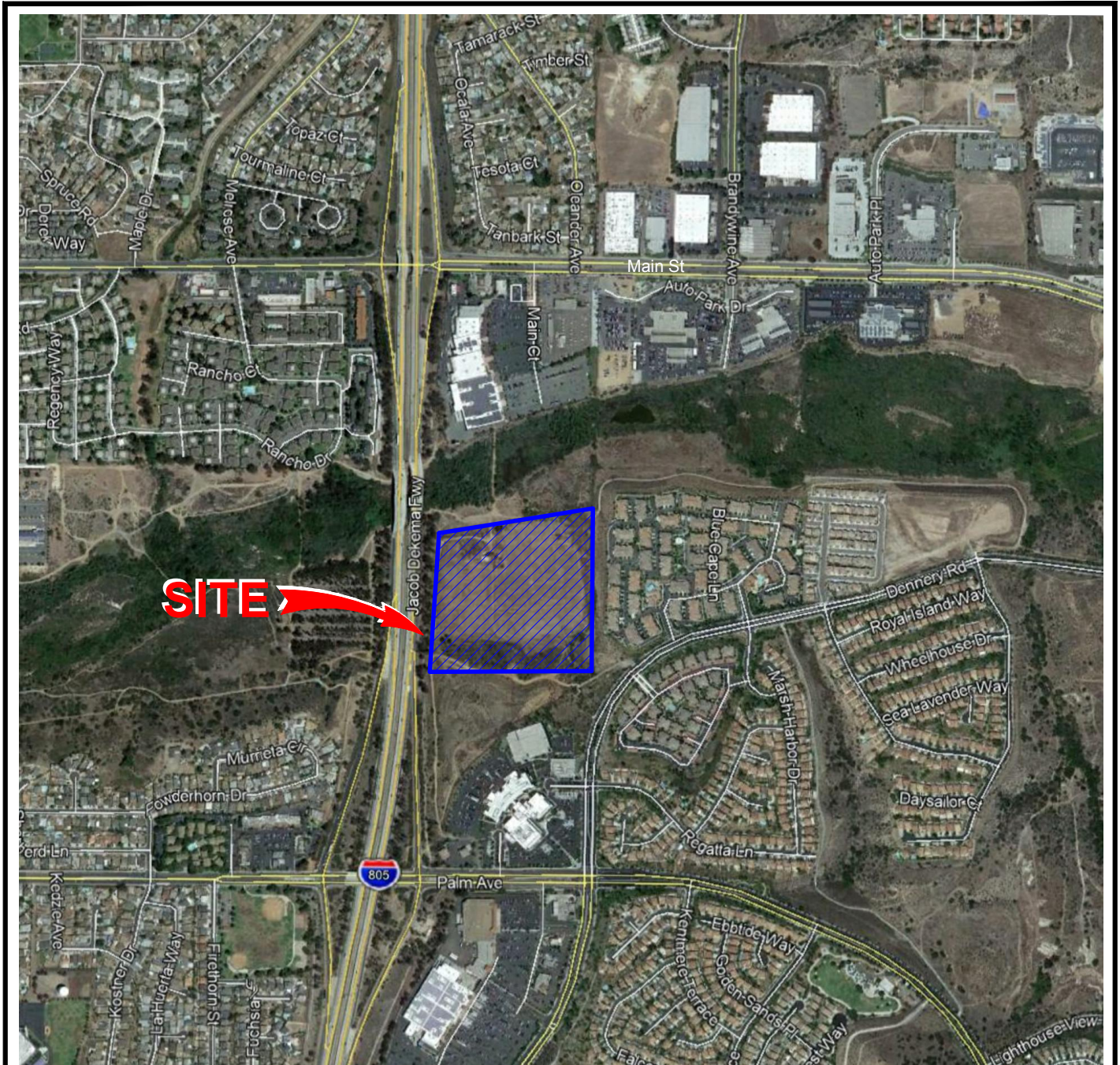

THE GEOGRAPHICAL INFORMATION MADE AVAILABLE FOR DISPLAY WAS PROVIDED BY GOOGLE EARTH, SUBJECT TO A LICENSING AGREEMENT. THE INFORMATION IS FOR ILLUSTRATIVE PURPOSES ONLY; IT IS NOT INTENDED FOR CLIENT'S USE OR RELIANCE AND SHALL NOT BE REPRODUCED BY CLIENT. CLIENT SHALL INDEMNIFY, DEFEND AND HOLD HARMLESS GEOCON FROM ANY LIABILITY INCURRED AS A RESULT OF SUCH USE OR RELIANCE BY CLIENT.



NO SCALE

VICINITY MAP

GEOCON
INCORPORATED



GEOTECHNICAL ■ ENVIRONMENTAL ■ MATERIALS
6960 FLANDERS DRIVE - SAN DIEGO, CALIFORNIA 92121 - 2974
PHONE 858 558-6900 - FAX 858 558-6159

NAKANO
CHULA VISTA, CALIFORNIA

RM / AML	DSK/GTYPD	DATE 09 - 18 - 2020	PROJECT NO. 07516 - 42 - 02	FIG. 1
----------	-----------	---------------------	-----------------------------	--------

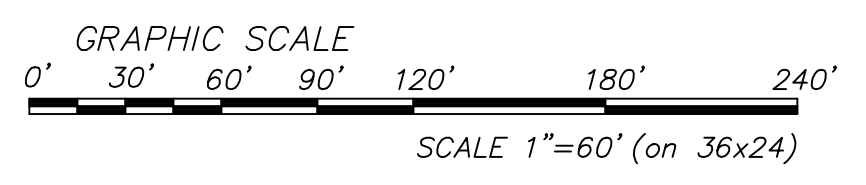
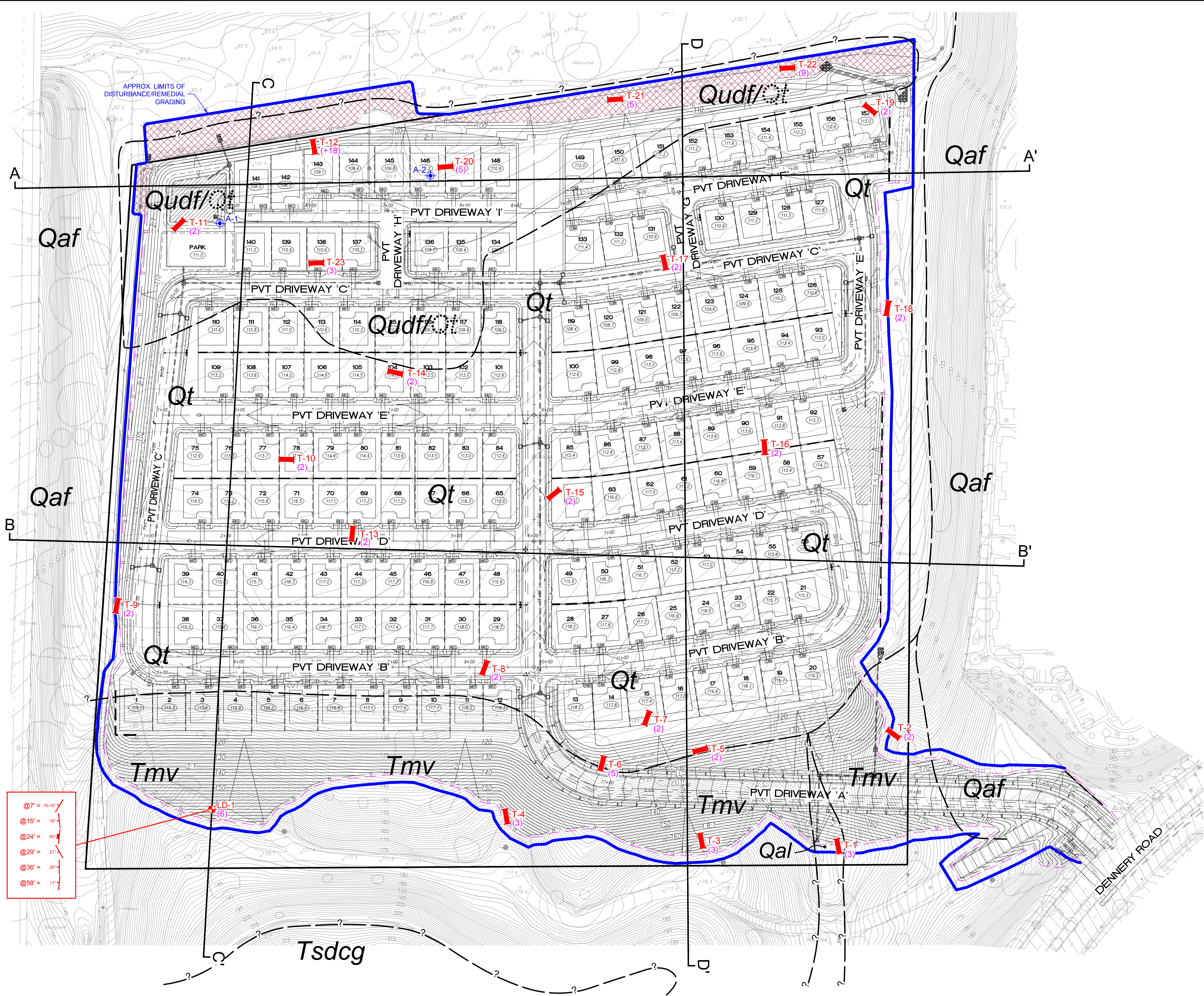

GEOCON LEGEND

- Qudf* UNDOCUMENTED FILL
- Qaf* ARTIFICIAL FILL
- Qal* ALLUVIUM
- Qt* TERRACE DEPOSITS
(Dotted Where Buried)
- Tsdcg* SAN DIEGO FORMATION (Conglomerate)
- Tmv* MISSION VALLEY FORMATION
- APPROX. LOCATION OF GEOLOGIC CONTACT
(Queried Where Uncertain)
- LD-1 APPROX. LOCATION OF BORING
- A-2 APPROX. LOCATION OF INFILTRATION TEST
- (5) APPROX. DEPTH OF REMEDIAL GRADING (in Feet, MSL)
- D APPROX. LOCATION OF GEOLOGIC CROSS SECTION

- @7' = 10-15'
- @15' = 16'
- @24' = 85'
- @29' = 21'
- @36' = 20'
- @58' = 11'

GEOLOGIC MAP		
NAKANO CHULA VISTA, CALIFORNIA		
GEOCON INCORPORATED	SCALE 1" = 60'	DATE 09 - 18 - 2020
GEO TECHNICAL ■ ENVIRONMENTAL ■ MATERIALS 6940 SANDERS DRIVE ■ SAN DIEGO, CALIFORNIA 92121-2974 PHONE 858.558.4900 ■ FAX 858.558.4159	PROJECT NO. 07516 - 42 - 02	FIGURE 2
SHEET 1 OF 1		

Printed 09/17/2020 10:27AM | By ALVIN LADRILLON | File Location V:\PROJ\07516-42-02 (Nakano)\SHEET\07516-42-02-02-Map 20.dwg

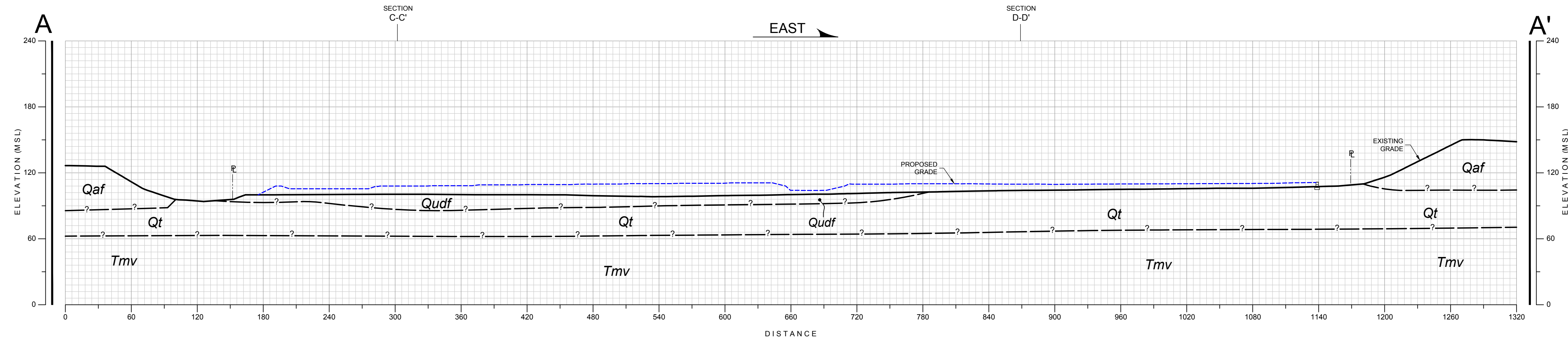

GEOLOGIC CROSS-SECTION A-A'
SCALE: 1" = 60' (Vert. = Horiz.)

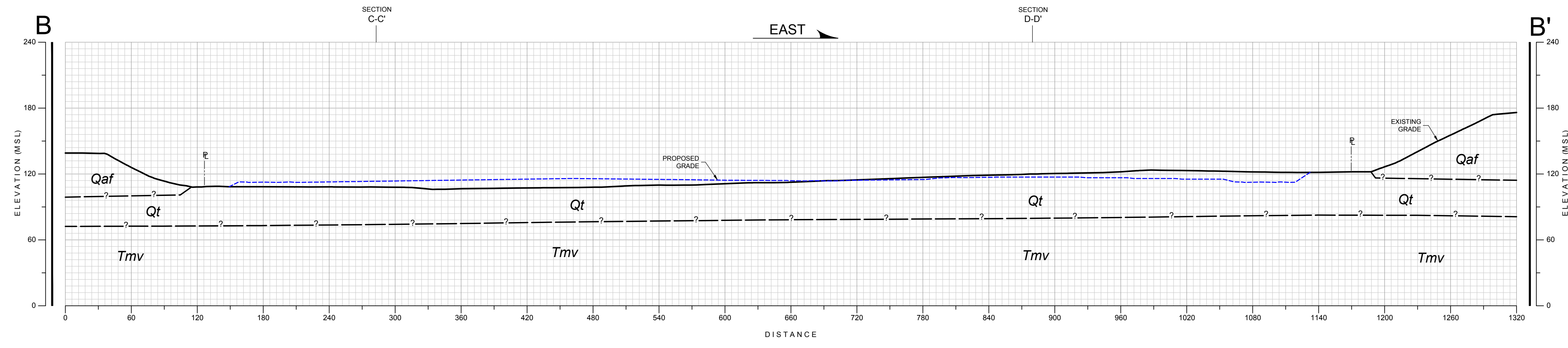

GEOLOGIC CROSS-SECTION B-B'
SCALE: 1" = 60' (Vert. = Horiz.)

GEOLOGIC CROSS SECTION			
NAKANO CHULA VISTA, CALIFORNIA			
GEOCON INCORPORATED GEOTECHNICAL ■ ENVIRONMENTAL ■ MATERIALS 6940 SANDERS DRIVE ■ SAN DIEGO, CALIFORNIA 92121-2974 PHONE 858.558.4900 ■ FAX 858.558.4159	SCALE 1" = 60'	DATE 09 - 18 - 2020	3
	PROJECT NO. 07516 - 42 - 02		
	SHEET 1 OF 2		

PlotNo:001170205 10.38AM | By ALVIN LADRILLONCO | File Location: Y:\PROJECTS\07516-42-02 (NAKANO)\SHEETS\07516-42-02 Section 20.dwg

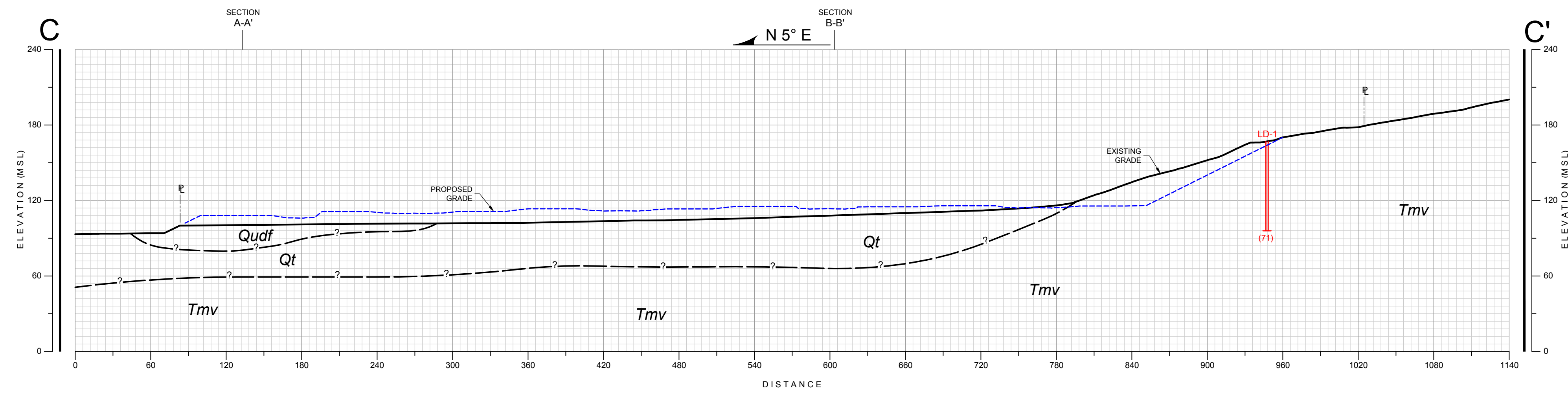

GEOLOGIC CROSS-SECTION C-C'
SCALE: 1" = 60' (Vert. = Horiz.)

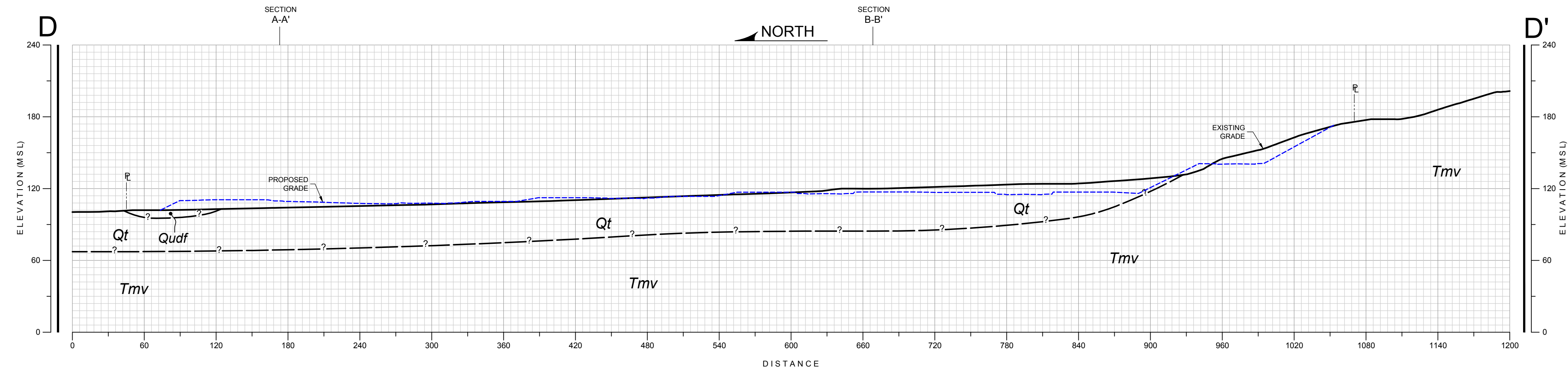

GEOLOGIC CROSS-SECTION D-D'
SCALE: 1" = 60' (Vert. = Horiz.)

GEOLOGIC CROSS SECTION			
NAKANO CHULA VISTA, CALIFORNIA			
GEOCON INCORPORATED <small>GEOTECHNICAL ■ ENVIRONMENTAL ■ MATERIALS</small> <small>6940 SANDERS DRIVE ■ SAN DIEGO, CALIFORNIA 92121-2974</small> <small>PHONE 858.558.4900 ■ FAX 858.558.6159</small>	SCALE	DATE	4
	PROJECT NO.	07516 - 42 - 02	
	SHEET	2 OF 2	
		1" = 60'	09 - 18 - 2020

Plotfile:001170205 10.38AM | By ALVIN LADRILLANO | File Location: Y:\PROJECTS\07516-42-02 (Nakano)\SHEETS\07516-42-02 (Section 2).dwg

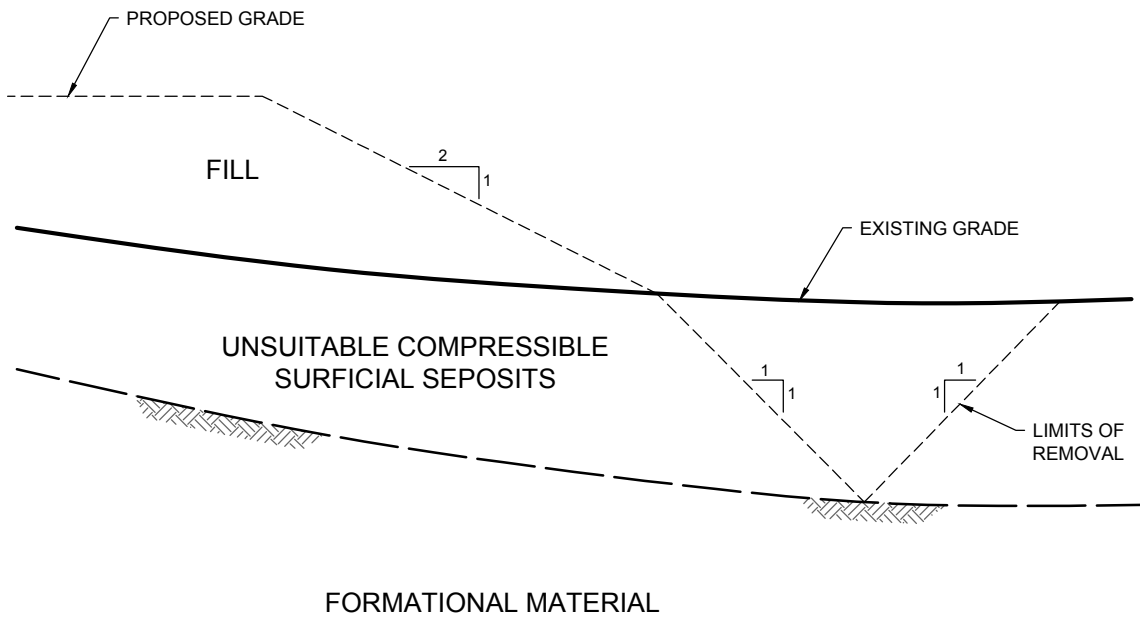

NOT TO SCALE

NOTE:

SLOPE OF BACKCUT MAY BE STEEPENED WITH THE APPROVAL OF THE PROJECT ENGINEER/GEOLOGIST WHERE BOUNDARY CONSTRAINTS LIMIT EXTENT OF REMOVALS

NO SCALE

CONSTRUCTION DETAIL FOR LATERAL EXTENT OF REMOVAL

GEOCON
INCORPORATED



GEOTECHNICAL ■ ENVIRONMENTAL ■ MATERIALS
6960 FLANDERS DRIVE - SAN DIEGO, CALIFORNIA 92121 - 2974
PHONE 858 558-6900 - FAX 858 558-6159

NAKANO
CHULA VISTA, CALIFORNIA

RM / AML

DSK/GTYPD

DATE 09 - 18 - 2020

PROJECT NO. 07516 - 42 - 02

FIG. 5

ASSUMED CONDITIONS :

SLOPE HEIGHT	H = 55 feet
SLOPE INCLINATION	2 : 1 (Horizontal : Vertical)
TOTAL UNIT WEIGHT OF SOIL	$\gamma_t = 120$ pounds per cubic foot
ANGLE OF INTERNAL FRICTION	$\phi = 30$ degrees
APPARENT COHESION	C = 675 pounds per square foot
NO SEEPAGE FORCES	

ANALYSIS :

$\lambda_{c\phi} = \frac{\gamma_t H \tan \phi}{C}$	EQUATION (3-3), REFERENCE 1
FS = $\frac{NcfC}{\gamma_t H}$	EQUATION (3-2), REFERENCE 1
$\lambda_{c\phi} = 5.6$	CALCULATED USING EQ. (3-3)
Ncf = 22	DETERMINED USING FIGURE 10, REFERENCE 2
FS = 2.2	FACTOR OF SAFETY CALCULATED USING EQ. (3-2)

REFERENCES :

- 1.....Janbu, N., Stability Analysis of Slopes with Dimensionless Parameters, Harvard Soil Mechanics, Series No. 46, 1954
- 2.....Janbu, N., Discussion of J.M. Bell, Dimensionless Parameters for Homogeneous Earth Slopes, Journal of Soil Mechanics and Foundation Design, No. SM6, November 1967.

SLOPE STABILITY ANALYSIS - CUT SLOPES

GEOCON
INCORPORATED



GEOTECHNICAL ■ ENVIRONMENTAL ■ MATERIALS
6960 FLANDERS DRIVE - SAN DIEGO, CALIFORNIA 92121 - 2974
PHONE 858 558-6900 - FAX 858 558-6159

NAKANO
CHULA VISTA, CALIFORNIA

RM / AML

DSK/GTYPD

DATE 09 - 18 - 2020

PROJECT NO. 07516 - 42 - 02

FIG. 6

ASSUMED CONDITIONS :

SLOPE HEIGHT	H = 120 feet
SLOPE INCLINATION	2.5 : 1 (Horizontal : Vertical)
TOTAL UNIT WEIGHT OF SOIL	$\gamma_t = 120$ pounds per cubic foot
ANGLE OF INTERNAL FRICTION	$\phi = 30$ degrees
APPARENT COHESION	C = 675 pounds per square foot
NO SEEPAGE FORCES	

ANALYSIS :

$\lambda_{c\phi} = \frac{\gamma_t H \tan \phi}{C}$	EQUATION (3-3), REFERENCE 1
FS = $\frac{N_{cf} C}{\gamma_t H}$	EQUATION (3-2), REFERENCE 1
$\lambda_{c\phi} = 12.3$	CALCULATED USING EQ. (3-3)
Ncf = 42	DETERMINED USING FIGURE 10, REFERENCE 2
FS = 2.0	FACTOR OF SAFETY CALCULATED USING EQ. (3-2)

REFERENCES :

- 1.....Janbu, N., Stability Analysis of Slopes with Dimensionless Parameters, Harvard Soil Mechanics, Series No. 46, 1954
- 2.....Janbu, N., Discussion of J.M. Bell, Dimensionless Parameters for Homogeneous Earth Slopes, Journal of Soil Mechanics and Foundation Design, No. SM6, November 1967.

SLOPE STABILITY ANALYSIS - NATIVE HILLSIDE

GEOCON
INCORPORATED



GEOTECHNICAL ■ ENVIRONMENTAL ■ MATERIALS
6960 FLANDERS DRIVE - SAN DIEGO, CALIFORNIA 92121 - 2974
PHONE 858 558-6900 - FAX 858 558-6159

NAKANO
CHULA VISTA, CALIFORNIA

RM / AML

DSK/GTYPD

DATE 09 - 18 - 2020

PROJECT NO. 07516 - 42 - 02

FIG. 7

ASSUMED CONDITIONS :

SLOPE HEIGHT	H = 10 feet
SLOPE INCLINATION	2 : 1 (Horizontal : Vertical)
TOTAL UNIT WEIGHT OF SOIL	$\gamma_t = 125$ pounds per cubic foot
ANGLE OF INTERNAL FRICTION	$\phi = 27$ degrees
APPARENT COHESION	C = 300 pounds per square foot
NO SEEPAGE FORCES	

ANALYSIS :

$\lambda_{c\phi} = \frac{\gamma_t H \tan \phi}{C}$	EQUATION (3-3), REFERENCE 1
FS = $\frac{N_{cf} C}{\gamma_t H}$	EQUATION (3-2), REFERENCE 1
$\lambda_{c\phi} = 2.1$	CALCULATED USING EQ. (3-3)
$N_{cf} = 13$	DETERMINED USING FIGURE 10, REFERENCE 2
FS = 3.1	FACTOR OF SAFETY CALCULATED USING EQ. (3-2)

REFERENCES :

- 1.....Janbu, N., Stability Analysis of Slopes with Dimensionless Parameters, Harvard Soil Mechanics, Series No. 46, 1954
- 2.....Janbu, N., Discussion of J.M. Bell, Dimensionless Parameters for Homogeneous Earth Slopes, Journal of Soil Mechanics and Foundation Design, No. SM6, November 1967.

SLOPE STABILITY ANALYSIS - FILL SLOPES

GEOCON
INCORPORATED



GEOTECHNICAL ■ ENVIRONMENTAL ■ MATERIALS
6960 FLANDERS DRIVE - SAN DIEGO, CALIFORNIA 92121 - 2974
PHONE 858 558-6900 - FAX 858 558-6159

NAKANO
CHULA VISTA, CALIFORNIA

RM / AML

DSK/GTYPD

DATE 09 - 18 - 2020

PROJECT NO. 07516 - 42 - 02

FIG. 8

ASSUMED CONDITIONS :

SLOPE HEIGHT	H = Infinite
DEPTH OF SATURATION	Z = 4 feet
SLOPE INCLINATION	2 : 1 (Horizontal : Vertical)
SLOPE ANGLE	i = 26.6 degrees
UNIT WEIGHT OF WATER	γ_w = 62.4 pounds per cubic foot
TOTAL UNIT WEIGHT OF SOIL	γ_t = 125 pounds per cubic foot
ANGLE OF INTERNAL FRICTION	ϕ = 27 degrees
APPARENT COHESION	C = 300 pounds per square foot

SLOPE SATURATED TO VERTICAL DEPTH Z BELOW SLOPE FACE

SEEPAGE FORCES PARALLEL TO SLOPE FACE

ANALYSIS :

$$FS = \frac{C + (\gamma_t - \gamma_w) Z \cos^2 i \tan \phi}{\gamma_t Z \sin i \cos i} = 2.0$$

REFERENCES :

- 1.....Haefeli, R. *The Stability of Slopes Acted Upon by Parallel Seepage*, Proc. Second International Conference, SMFE, Rotterdam, 1948, 1, 57-62
- 2.....Skempton, A. W., and F.A. Delory, *Stability of Natural Slopes in London Clay*, Proc. Fourth International Conference, SMFE, London, 1957, 2, 378-81

SURFICIAL SLOPE STABILITY ANALYSIS

GEOCON
INCORPORATED



GEOTECHNICAL ■ ENVIRONMENTAL ■ MATERIALS
6960 FLANDERS DRIVE - SAN DIEGO, CALIFORNIA 92121 - 2974
PHONE 858 558-6900 - FAX 858 558-6159

NAKANO
CHULA VISTA, CALIFORNIA

RM / AML

DSK/GTYPD

DATE 09 - 18 - 2020

PROJECT NO. 07516 - 42 - 02

FIG. 9

APPENDIX

A

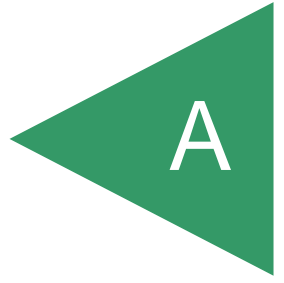

APPENDIX A

FIELD INVESTIGATION

Our original field investigation performed on April 14, 2005, consisted of a site reconnaissance and logging of exploratory trenches excavated with a rubber-tired backhoe. The approximate locations of the exploratory trenches are shown on Figure 2. The backhoe trenches were excavated to depths between 2 and 18 feet below the existing ground surface using a JD 305 backhoe equipped with a 24-inch-wide bucket.

Our recent field investigation performed on January 3, 2020, consisted of a site reconnaissance and logging of one large diameter boring excavated with a truck mounted EZ-Bore drill rig using a 30-inch diameter bucket auger. The boring was advanced to a depth of 70 feet below existing grades near the top of slope on the south side of the site. The boring was backfilled in accordance with County of San Diego guidelines.







For the large diameter boring, the samplers were driven 12 inches into the bottom of the excavations with the use of a telescoping Kelly bar. The weight of the Kelly bar (4,500 lbs. maximum) drives the sampler and varies with depth. The height of drop is usually 12 inches. Blow counts are recorded for every 12 inches the sampler is driven. The penetration resistance values shown on the boring logs are shown in terms of blows per foot. These values are not to be taken as N-values; adjustments have not been applied. Elevations shown on the boring logs were determined either from a topographic map or by using a benchmark.

The soil conditions encountered in the trenches were visually examined, classified, and logged in general conformance with the American Society for Testing and Materials (ASTM) Practice for Description and Identification of Soils (Visual-Manual Procedure D 2488-00). The logs of the exploratory trenches are presented on Figures A-1 through A-23. The logs depict the various soil types encountered and indicate the depths at which samples were obtained.

DEPTH IN FEET	SAMPLE NO.	LITHOLOGY	GROUNDWATER	SOIL CLASS (USCS)	BORING LD 1		PENETRATION RESISTANCE (BLOWS/FT.)	DRY DENSITY (P.C.F.)	MOISTURE CONTENT (%)
					ELEV. (MSL.) <u>+/-168'</u>	DATE COMPLETED <u>01-03-2020</u>			
					EQUIPMENT <u>EZ BORE</u>		BY: <u>R. ADAMS</u>		
MATERIAL DESCRIPTION									
0				SM	UNDOCUMENTED FILL (Qudf) Loose to medium dense, damp, grayish-brown, Silty SAND; some cobble, trace clay				
2									
4				SC	COLLUVIUM (Qcol) Medium dense, damp, brown and grayish brown, Clayey SAND; some gravel and cobble. Cobble is sub-rounded up to 10-inch in width				
6									
8				SM	MISSION VALLEY FORMATION (Tmv) Irregular contact at 6-7 feet Medium dense to dense, damp, pale yellowish-orange to whitish orange, very fine grained Silty SAND; micaceous, friable, massive to weakly laminated/bedded				
10	LD1-1				-At 7 feet: thin 2-inch thick gravel bed. Gravel is sub-rounded 1/2-inch to 3-inch in width. Bedding: N30E/10-15°W (undulatory)		3		
12									
14									
16					-At 15 feet: grayish white 3/4-inch thick sand bed. Bedding: N5W/16°W				
18					-At 17 feet: 6-inch thick clayey sand/gravel bed; gravel sub-rounded 1/2 to 4-inch in width				
20	LD1-2			SM	Dense, damp, whitish gray, very fine grained Silty SAND; highly micaceous, abundant lithic grains, weakly to moderately laminated		3		
22									
24					-At 24 feet: 1/4-1/2-inch sand filled fractures. N5E/65°E				
26									
28					-At 29 feet: bedding N31W/21°W				

Figure A-1,
Log of Boring LD 1, Page 1 of 3

07516-42-02.GPJ

SAMPLE SYMBOLS	 ... SAMPLING UNSUCCESSFUL	 ... STANDARD PENETRATION TEST	 ... DRIVE SAMPLE (UNDISTURBED)
	 ... DISTURBED OR BAG SAMPLE	 ... CHUNK SAMPLE	 ... WATER TABLE OR SEEPAGE

NOTE: THE LOG OF SUBSURFACE CONDITIONS SHOWN HEREON APPLIES ONLY AT THE SPECIFIC BORING OR TRENCH LOCATION AND AT THE DATE INDICATED. IT IS NOT WARRANTED TO BE REPRESENTATIVE OF SUBSURFACE CONDITIONS AT OTHER LOCATIONS AND TIMES.

DEPTH IN FEET	SAMPLE NO.	LITHOLOGY	GROUNDWATER	SOIL CLASS (USCS)	BORING LD 1		PENETRATION RESISTANCE (BLOWS/FT.)	DRY DENSITY (P.C.F.)	MOISTURE CONTENT (%)
					ELEV. (MSL.) <u>+/-168'</u>	DATE COMPLETED <u>01-03-2020</u>			
					EQUIPMENT <u>EZ BORE</u> BY: <u>R. ADAMS</u>				
					MATERIAL DESCRIPTION				
30	LD1-3			SM	-At 30 feet: becomes dense to very dense		6		
32									
34									
36					-At 36 feet: small 12-inch wide clay filled load structure (small channel). Bedding: N-S/20°W				
38					-At 38 feet: 4-inch thick gray brown sandy clay bed; not remolded				
40	LD1-4				-At 39 feet: dense, damp, whitish gray, medium coarse sand bed; trace sub-rounded gravel up to 4-inch in width -At 40 feet: few oval white-sand filled burrows (krotovina) 2 to 4-inch diameter.		7		
42					-At 41 feet: 1/4-inch wide, high angle sand filled fracture with partial caliche infill.				
44									
46					-At 45 feet: becomes white, fine to medium grained silty sand				
48									
50	LD1-5				-No sample recovery at 50 feet		10		
52	LD1-5						15		
54									
56									
58					-At 58 feet: bedding N5E/11°W				

Figure A-1,
Log of Boring LD 1, Page 2 of 3

07516-42-02.GPJ

SAMPLE SYMBOLS	... SAMPLING UNSUCCESSFUL	... STANDARD PENETRATION TEST	... DRIVE SAMPLE (UNDISTURBED)
	... DISTURBED OR BAG SAMPLE	... CHUNK SAMPLE	... WATER TABLE OR SEEPAGE

NOTE: THE LOG OF SUBSURFACE CONDITIONS SHOWN HEREON APPLIES ONLY AT THE SPECIFIC BORING OR TRENCH LOCATION AND AT THE DATE INDICATED. IT IS NOT WARRANTED TO BE REPRESENTATIVE OF SUBSURFACE CONDITIONS AT OTHER LOCATIONS AND TIMES.

DEPTH IN FEET	SAMPLE NO.	LITHOLOGY	GROUNDWATER	SOIL CLASS (USCS)	BORING LD 1 ELEV. (MSL.) <u>+/-168'</u> DATE COMPLETED <u>01-03-2020</u> EQUIPMENT <u>EZ BORE</u> BY: <u>R. ADAMS</u>	PENETRATION RESISTANCE (BLOWS/FT.)	DRY DENSITY (P.C.F.)	MOISTURE CONTENT (%)
60					MATERIAL DESCRIPTION Dense to very dense, damp, white to orange-white Silty, fine to medium SAND; trace gravel, laminated and weakly bedded, friable			
62								
64								
66								
68								
70	LD1-6			SM		10		
					TERMINATED AT 71 FEET No groundwater encountered Backfilled 01-03-2020			

Figure A-1,
Log of Boring LD 1, Page 3 of 3

07516-42-02.GPJ

SAMPLE SYMBOLS		... SAMPLING UNSUCCESSFUL		... STANDARD PENETRATION TEST		... DRIVE SAMPLE (UNDISTURBED)
		... DISTURBED OR BAG SAMPLE		... CHUNK SAMPLE		... WATER TABLE OR SEEPAGE

NOTE: THE LOG OF SUBSURFACE CONDITIONS SHOWN HEREON APPLIES ONLY AT THE SPECIFIC BORING OR TRENCH LOCATION AND AT THE DATE INDICATED. IT IS NOT WARRANTED TO BE REPRESENTATIVE OF SUBSURFACE CONDITIONS AT OTHER LOCATIONS AND TIMES.









DEPTH IN FEET	SAMPLE NO.	LITHOLOGY	GROUNDWATER	SOIL CLASS (USCS)	TRENCH T 1		PENETRATION RESISTANCE (BLOWS/FT.)	DRY DENSITY (P.C.F.)	MOISTURE CONTENT (%)
					ELEV. (MSL.) <u>142'</u>	DATE COMPLETED <u>04-14-2005</u>			
					EQUIPMENT <u>JD 305</u> BY: <u>C. JENSEN</u>				
					MATERIAL DESCRIPTION				
0	T1-1			SM	ALLUVIUM Loose, humid, light brown, Silty, fine-grained SAND with roots				
2				SC					
	T1-2			SC	Moderately dense, moist to wet, brown, Clayey SAND with roots and gravel				
4				SC/CL	TERRACE DEPOSIT Stiff, moist, reddish brown, yellow, gray and black, Cobbly, Clayey GRAVEL with little fine- to coarse-grained sand, with angular to subrounded gravel and cobble up to 6" diameter				
6									
8				SP	Dense to very dense, damp, reddish brown, Cobbly SAND with cobble up to 6" diameter				
10	TRENCH TERMINATED AT 10 FEET								

Figure A-2,
Log of Trench T 1, Page 1 of 1

07516-42-02.GPJ

SAMPLE SYMBOLS	 ... SAMPLING UNSUCCESSFUL	 ... STANDARD PENETRATION TEST	 ... DRIVE SAMPLE (UNDISTURBED)
	 ... DISTURBED OR BAG SAMPLE	 ... CHUNK SAMPLE	 ... WATER TABLE OR SEEPAGE

NOTE: THE LOG OF SUBSURFACE CONDITIONS SHOWN HEREON APPLIES ONLY AT THE SPECIFIC BORING OR TRENCH LOCATION AND AT THE DATE INDICATED. IT IS NOT WARRANTED TO BE REPRESENTATIVE OF SUBSURFACE CONDITIONS AT OTHER LOCATIONS AND TIMES.







DEPTH IN FEET	SAMPLE NO.	LITHOLOGY	GROUNDWATER	SOIL CLASS (USCS)	TRENCH T 2		PENETRATION RESISTANCE (BLOWS/FT.)	DRY DENSITY (P.C.F.)	MOISTURE CONTENT (%)
					ELEV. (MSL.) <u>160'</u>	DATE COMPLETED <u>04-14-2005</u>			
					EQUIPMENT <u>JD 305</u> BY: <u>C. JENSEN</u>				
MATERIAL DESCRIPTION									
0				SC	TOPSOIL Loose to moderately dense, dry, reddish brown, Clayey SAND with gravel, cobbles and roots				
2				CL	TERRACE DEPOSITS Strong to very strong, humid, reddish brown, Clayey, CONGLOMERATE, very difficult digging				
					TRENCH TERMINATED AT 2 FEET				

Figure A-3,
Log of Trench T 2, Page 1 of 1

07516-42-02.GPJ

SAMPLE SYMBOLS	 ... SAMPLING UNSUCCESSFUL	 ... STANDARD PENETRATION TEST	 ... DRIVE SAMPLE (UNDISTURBED)
	 ... DISTURBED OR BAG SAMPLE	 ... CHUNK SAMPLE	 ... WATER TABLE OR SEEPAGE

NOTE: THE LOG OF SUBSURFACE CONDITIONS SHOWN HEREON APPLIES ONLY AT THE SPECIFIC BORING OR TRENCH LOCATION AND AT THE DATE INDICATED. IT IS NOT WARRANTED TO BE REPRESENTATIVE OF SUBSURFACE CONDITIONS AT OTHER LOCATIONS AND TIMES.

DEPTH IN FEET	SAMPLE NO.	LITHOLOGY	GROUNDWATER	SOIL CLASS (USCS)	TRENCH T 3		PENETRATION RESISTANCE (BLOWS/FT.)	DRY DENSITY (P.C.F.)	MOISTURE CONTENT (%)
					ELEV. (MSL.) <u>170'</u>	DATE COMPLETED <u>04-14-2005</u>			
					EQUIPMENT <u>JD 305</u> BY: <u>C. JENSEN</u>				
MATERIAL DESCRIPTION									
0	T3-1			GP	TOPSOIL Loose, dry, brown, Sandy COBBLE with cobbles up to 6" diameter with roots				
2			CL	Firm, damp, brown, Sandy CLAY with roots					
4	T3-2			SM	MISSION VALLEY FORMATION Moderately dense, weak, humid, tan, Silty, very fine-grained SAND, porous				
6			SM	Dense, humid, weak to friable, deeply weathered, humid, light reddish brown, fine to medium-grained SANDSTONE					
8					TRENCH TERMINATED AT 9 FEET				

Figure A-4,
Log of Trench T 3, Page 1 of 1

07516-42-02.GPJ

SAMPLE SYMBOLS		... SAMPLING UNSUCCESSFUL		... STANDARD PENETRATION TEST		... DRIVE SAMPLE (UNDISTURBED)
		... DISTURBED OR BAG SAMPLE		... CHUNK SAMPLE		... WATER TABLE OR SEEPAGE

NOTE: THE LOG OF SUBSURFACE CONDITIONS SHOWN HEREON APPLIES ONLY AT THE SPECIFIC BORING OR TRENCH LOCATION AND AT THE DATE INDICATED. IT IS NOT WARRANTED TO BE REPRESENTATIVE OF SUBSURFACE CONDITIONS AT OTHER LOCATIONS AND TIMES.

DEPTH IN FEET	SAMPLE NO.	LITHOLOGY	GROUNDWATER	SOIL CLASS (USCS)	TRENCH T 4		PENETRATION RESISTANCE (BLOWS/FT.)	DRY DENSITY (P.C.F.)	MOISTURE CONTENT (%)	
					ELEV. (MSL.) <u>170'</u>	DATE COMPLETED <u>04-14-2005</u>				
					EQUIPMENT <u>JD 305</u> BY: <u>C. JENSEN</u>					
					MATERIAL DESCRIPTION					
0				GP	TOPSOIL Loose to moderately dense, dry, brown, Sandy COBBLE with roots and boulders approximately 2 feet in diameter					
2			CL	Firm, humid, brown, Sandy CLAY with roots						
4				SM	MISSION VALLEY FORMATION Moderately dense to dense, weak to friable, humid, light reddish brown, fine to medium-grained, SANDSTONE					
6										
8										
10						TRENCH TERMINATED AT 10 FEET				

Figure A-5,
Log of Trench T 4, Page 1 of 1

07516-42-02.GPJ

SAMPLE SYMBOLS	... SAMPLING UNSUCCESSFUL	... STANDARD PENETRATION TEST	... DRIVE SAMPLE (UNDISTURBED)
	... DISTURBED OR BAG SAMPLE	... CHUNK SAMPLE	... WATER TABLE OR SEEPAGE

NOTE: THE LOG OF SUBSURFACE CONDITIONS SHOWN HEREON APPLIES ONLY AT THE SPECIFIC BORING OR TRENCH LOCATION AND AT THE DATE INDICATED. IT IS NOT WARRANTED TO BE REPRESENTATIVE OF SUBSURFACE CONDITIONS AT OTHER LOCATIONS AND TIMES.









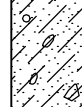

DEPTH IN FEET	SAMPLE NO.	LITHOLOGY	GROUNDWATER	SOIL CLASS (USCS)	TRENCH T 5		PENETRATION RESISTANCE (BLOWS/FT.)	DRY DENSITY (P.C.F.)	MOISTURE CONTENT (%)	
					ELEV. (MSL.) <u>135'</u>	DATE COMPLETED <u>04-14-2005</u>				
					EQUIPMENT <u>JD 305</u> BY: <u>C. JENSEN</u>					
MATERIAL DESCRIPTION										
0				SM	TOPSOIL Loose to moderately dense, humid, brown, Silty, fine grained SAND with roots					
2				SC	TERRACE DEPOSIT Moderately dense, humid, dark brown, Clayey SAND with gravels and cobbles					
4	T5-1									
6										
8										
10										
12										
TRENCH TERMINATED AT 12 FEET										

Figure A-6,
Log of Trench T 5, Page 1 of 1

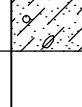
07516-42-02.GPJ

SAMPLE SYMBOLS		... SAMPLING UNSUCCESSFUL		... STANDARD PENETRATION TEST		... DRIVE SAMPLE (UNDISTURBED)
		... DISTURBED OR BAG SAMPLE		... CHUNK SAMPLE		... WATER TABLE OR SEEPAGE

NOTE: THE LOG OF SUBSURFACE CONDITIONS SHOWN HEREON APPLIES ONLY AT THE SPECIFIC BORING OR TRENCH LOCATION AND AT THE DATE INDICATED. IT IS NOT WARRANTED TO BE REPRESENTATIVE OF SUBSURFACE CONDITIONS AT OTHER LOCATIONS AND TIMES.











DEPTH IN FEET	SAMPLE NO.	LITHOLOGY	GROUNDWATER	SOIL CLASS (USCS)	TRENCH T 6		PENETRATION RESISTANCE (BLOWS/FT.)	DRY DENSITY (P.C.F.)	MOISTURE CONTENT (%)
					ELEV. (MSL.) <u>130'</u>	DATE COMPLETED <u>04-14-2005</u>			
					EQUIPMENT <u>JD 305</u> BY: <u>C. JENSEN</u>				
					MATERIAL DESCRIPTION				
0				SM	TOPSOIL Loose to moderately dense, humid, light brown, Silty SAND with roots				
2				SC	COLLUVIUM Moderately dense to dense, damp to moist, olive brown, Clayey SAND with cobbles, with roots, cobbles up to 8" diameter				
4				SC/CL	TERRACE DEPOSIT Stiff, moist, reddish brown, yellow and black, Sandy CLAY with cobbles and gravel				
6				GC	Dense to very dense, humid, Sandy COBBLES with clay, angular to sub-rounded cobbles up to 1 foot diameter				
					TRENCH TERMINATED AT 7 FEET				

Figure A-7,
Log of Trench T 6, Page 1 of 1

07516-42-02.GPJ







SAMPLE SYMBOLS	 ... SAMPLING UNSUCCESSFUL	 ... STANDARD PENETRATION TEST	 ... DRIVE SAMPLE (UNDISTURBED)
	 ... DISTURBED OR BAG SAMPLE	 ... CHUNK SAMPLE	 ... WATER TABLE OR SEEPAGE

NOTE: THE LOG OF SUBSURFACE CONDITIONS SHOWN HEREON APPLIES ONLY AT THE SPECIFIC BORING OR TRENCH LOCATION AND AT THE DATE INDICATED. IT IS NOT WARRANTED TO BE REPRESENTATIVE OF SUBSURFACE CONDITIONS AT OTHER LOCATIONS AND TIMES.

DEPTH IN FEET	SAMPLE NO.	LITHOLOGY	GROUNDWATER	SOIL CLASS (USCS)	TRENCH T 7		PENETRATION RESISTANCE (BLOWS/FT.)	DRY DENSITY (P.C.F.)	MOISTURE CONTENT (%)
					ELEV. (MSL.) <u>125'</u>	DATE COMPLETED <u>04-14-2005</u>			
					EQUIPMENT <u>JD 305</u>		BY: <u>C. JENSEN</u>		
MATERIAL DESCRIPTION									
0				SM	TOPSOIL Loose to moderately dense, humid, brown, Silty, fine-grained SAND with roots				
2				SC	TERRACE DEPOSIT Moderately dense to dense, damp, brown, Clayey, fine-grained SAND with gravel and cobbles				
4									
6	T7-1			CL	Firm to stiff, moist, mottled reddish brown and gray, Sandy CLAY with gravel and cobbles				
8									
10	T7-2			CL	Stiff, moist, gray with reddish brown, Silty CLAY with cobbles up to 6" diameter				
12									
TRENCH TERMINATED AT 13 FEET									

Figure A-8,
Log of Trench T 7, Page 1 of 1

07516-42-02.GPJ

SAMPLE SYMBOLS	 ... SAMPLING UNSUCCESSFUL	 ... STANDARD PENETRATION TEST	 ... DRIVE SAMPLE (UNDISTURBED)
	 ... DISTURBED OR BAG SAMPLE	 ... CHUNK SAMPLE	 ... WATER TABLE OR SEEPAGE

NOTE: THE LOG OF SUBSURFACE CONDITIONS SHOWN HEREON APPLIES ONLY AT THE SPECIFIC BORING OR TRENCH LOCATION AND AT THE DATE INDICATED. IT IS NOT WARRANTED TO BE REPRESENTATIVE OF SUBSURFACE CONDITIONS AT OTHER LOCATIONS AND TIMES.

DEPTH IN FEET	SAMPLE NO.	LITHOLOGY	GROUNDWATER	SOIL CLASS (USCS)	TRENCH T 8		PENETRATION RESISTANCE (BLOWS/FT.)	DRY DENSITY (P.C.F.)	MOISTURE CONTENT (%)
					ELEV. (MSL.) <u>115'</u>	DATE COMPLETED <u>04-14-2005</u>			
					EQUIPMENT <u>JD 305</u> BY: <u>C. JENSEN</u>				
MATERIAL DESCRIPTION									
0	T8-1			SM	TOPSOIL Loose to moderately dense, humid, brown, Silty, fine-grained SAND with roots charcoal and organics				
2				SM	Moderately dense, humid, light reddish brown, Silty SAND with roots				
4				SC	TERRACE DEPOSIT Moderately dense to dense, damp, dark grayish brown, Clayey SAND with trace lenses of light reddish brown silty sand				
				SC	Very dense, humid, dark brown, Clayey SAND				
TRENCH TERMINATED AT 5.5 FEET									

Figure A-9,
Log of Trench T 8, Page 1 of 1

07516-42-02.GPJ

SAMPLE SYMBOLS	... SAMPLING UNSUCCESSFUL	... STANDARD PENETRATION TEST	... DRIVE SAMPLE (UNDISTURBED)
	... DISTURBED OR BAG SAMPLE	... CHUNK SAMPLE	... WATER TABLE OR SEEPAGE

NOTE: THE LOG OF SUBSURFACE CONDITIONS SHOWN HEREON APPLIES ONLY AT THE SPECIFIC BORING OR TRENCH LOCATION AND AT THE DATE INDICATED. IT IS NOT WARRANTED TO BE REPRESENTATIVE OF SUBSURFACE CONDITIONS AT OTHER LOCATIONS AND TIMES.









DEPTH IN FEET	SAMPLE NO.	LITHOLOGY	GROUNDWATER	SOIL CLASS (USCS)	TRENCH T 9		PENETRATION RESISTANCE (BLOWS/FT.)	DRY DENSITY (P.C.F.)	MOISTURE CONTENT (%)
					ELEV. (MSL.) <u>110'</u>	DATE COMPLETED <u>04-14-2005</u>			
					EQUIPMENT <u>JD 305</u> BY: <u>C. JENSEN</u>				
MATERIAL DESCRIPTION									
0				CL	TOPSOIL Firm, humid, dark brown, Sandy CLAY with roots and gravel				
2	T9-1			CL	TERRACE DEPOSIT Very stiff, humid, dark brown, Silty CLAY with cobbles, with interbedded gravel and cobble lenses		121.2	11.9	
TRENCH TERMINATED AT 3.5 FEET									

Figure A-10,
Log of Trench T 9, Page 1 of 1

07516-42-02.GPJ

SAMPLE SYMBOLS	 ... SAMPLING UNSUCCESSFUL	 ... STANDARD PENETRATION TEST	 ... DRIVE SAMPLE (UNDISTURBED)
	 ... DISTURBED OR BAG SAMPLE	 ... CHUNK SAMPLE	 ... WATER TABLE OR SEEPAGE

NOTE: THE LOG OF SUBSURFACE CONDITIONS SHOWN HEREON APPLIES ONLY AT THE SPECIFIC BORING OR TRENCH LOCATION AND AT THE DATE INDICATED. IT IS NOT WARRANTED TO BE REPRESENTATIVE OF SUBSURFACE CONDITIONS AT OTHER LOCATIONS AND TIMES.

DEPTH IN FEET	SAMPLE NO.	LITHOLOGY	GROUNDWATER	SOIL CLASS (USCS)	TRENCH T 10		PENETRATION RESISTANCE (BLOWS/FT.)	DRY DENSITY (P.C.F.)	MOISTURE CONTENT (%)
					ELEV. (MSL.) <u>105'</u>	DATE COMPLETED <u>04-14-2005</u>			
					EQUIPMENT <u>JD 305</u>		BY: <u>C. JENSEN</u>		
MATERIAL DESCRIPTION									
0				SC	TOPSOIL Loose to moderately dense, dry, light brown, Clayey SAND with roots				
2						TERRACE DEPOSIT Dense, humid to damp, dark brown, Clayey SAND			
4				SC					
6									
8									
10									
12				SP	Very dense, damp, dark brown, Cobbly fine-grained SAND with subangular to subrounded gravel and cobbles up to 1 foot diameter				
14				SM	Dense, moist, dark reddish brown, Gravelly, fine to medium-grained SAND with trace cobbles				
TRENCH TERMINATED AT 15 FEET									

Figure A-11,
Log of Trench T 10, Page 1 of 1

07516-42-02.GPJ

SAMPLE SYMBOLS		... SAMPLING UNSUCCESSFUL		... STANDARD PENETRATION TEST		... DRIVE SAMPLE (UNDISTURBED)
		... DISTURBED OR BAG SAMPLE		... CHUNK SAMPLE		... WATER TABLE OR SEEPAGE

NOTE: THE LOG OF SUBSURFACE CONDITIONS SHOWN HEREON APPLIES ONLY AT THE SPECIFIC BORING OR TRENCH LOCATION AND AT THE DATE INDICATED. IT IS NOT WARRANTED TO BE REPRESENTATIVE OF SUBSURFACE CONDITIONS AT OTHER LOCATIONS AND TIMES.







DEPTH IN FEET	SAMPLE NO.	LITHOLOGY	GROUNDWATER	SOIL CLASS (USCS)	TRENCH T 11		PENETRATION RESISTANCE (BLOWS/FT.)	DRY DENSITY (P.C.F.)	MOISTURE CONTENT (%)
					ELEV. (MSL.) <u>100'</u>	DATE COMPLETED <u>04-14-2005</u>			
					EQUIPMENT <u>JD 305</u> BY: <u>C. JENSEN</u>				
MATERIAL DESCRIPTION									
0				SC	ARTIFICIAL FILL Moderately dense, damp, brown, Clayey SAND with roots				
2				GC	TERRACE DEPOSITS Dense to stiff, moist, reddish brown, Cobbly Sandy CLAY with gravel and cobbles up to 1 foot diameter				
4									
6									
TRENCH TERMINATED AT 7 FEET									

Figure A-12,
Log of Trench T 11, Page 1 of 1

07516-42-02.GPJ

SAMPLE SYMBOLS	 ... SAMPLING UNSUCCESSFUL	 ... STANDARD PENETRATION TEST	 ... DRIVE SAMPLE (UNDISTURBED)
	 ... DISTURBED OR BAG SAMPLE	 ... CHUNK SAMPLE	 ... WATER TABLE OR SEEPAGE

NOTE: THE LOG OF SUBSURFACE CONDITIONS SHOWN HEREON APPLIES ONLY AT THE SPECIFIC BORING OR TRENCH LOCATION AND AT THE DATE INDICATED. IT IS NOT WARRANTED TO BE REPRESENTATIVE OF SUBSURFACE CONDITIONS AT OTHER LOCATIONS AND TIMES.

DEPTH IN FEET	SAMPLE NO.	LITHOLOGY	GROUNDWATER	SOIL CLASS (USCS)	TRENCH T 12		PENETRATION RESISTANCE (BLOWS/FT.)	DRY DENSITY (P.C.F.)	MOISTURE CONTENT (%)
					ELEV. (MSL.) <u>100'</u>	DATE COMPLETED <u>04-14-2005</u>			
					EQUIPMENT <u>JD 305</u> BY: <u>C. JENSEN</u>				
MATERIAL DESCRIPTION									
0	T12-1			SM	ARTIFICIAL FILL Very loose to loose, dry, light brown to white, Silty, fine-grained SAND with roots, with plastic				
2				SM	Loose to moderately dense, humid, light reddish brown, Silty, fine-grained SAND with roots				
4				SM	Moderately dense, humid, light brown, Silty, fine-grained SAND with roots				
6				GP-GM	Moderately dense to dense, humid, dark brown, Sandy COBBLES with asphalt debris				
8				SM	Moderately dense, humid, olive, Silty, fine-grained SAND with plastic and cobbles				
10				SM	Moderately dense, moist, greenish gray, Silty, fine-grained SAND with plastic pipe with cobbles up to 1.5 feet in diameter				
12				SM					
14									
16									
18					TRENCH TERMINATED AT 18 FEET				

Figure A-13,
Log of Trench T 12, Page 1 of 1

07516-42-02.GPJ

SAMPLE SYMBOLS		... SAMPLING UNSUCCESSFUL		... STANDARD PENETRATION TEST		... DRIVE SAMPLE (UNDISTURBED)
		... DISTURBED OR BAG SAMPLE		... CHUNK SAMPLE		... WATER TABLE OR SEEPAGE

NOTE: THE LOG OF SUBSURFACE CONDITIONS SHOWN HEREON APPLIES ONLY AT THE SPECIFIC BORING OR TRENCH LOCATION AND AT THE DATE INDICATED. IT IS NOT WARRANTED TO BE REPRESENTATIVE OF SUBSURFACE CONDITIONS AT OTHER LOCATIONS AND TIMES.









DEPTH IN FEET	SAMPLE NO.	LITHOLOGY	GROUNDWATER	SOIL CLASS (USCS)	TRENCH T 13		PENETRATION RESISTANCE (BLOWS/FT.)	DRY DENSITY (P.C.F.)	MOISTURE CONTENT (%)
					ELEV. (MSL.) <u>105'</u>	DATE COMPLETED <u>04-15-2005</u>			
					EQUIPMENT <u>JD 305</u> BY: <u>C. JENSEN</u>				
MATERIAL DESCRIPTION									
0				SM	TOPSOIL Moderately dense, dry to damp, brown, Silty, fine-grained SAND with roots				
2				SC	TERRACE DEPOSIT Moderately dense, moist, dark brown, Clayey, fine-grained SAND with carbonate				
4					Stiff to very stiff, moist, dark brown, Sandy CLAY				
6				CL					
8									
10									
12									
14				SP	Dense to very dense, damp, brown, Gravelly, fine to medium grained SAND with subrounded to subangular gravel and cobbles up to 4" diameter				
TRENCH TERMINATED AT 14 FEET									

Figure A-14,
Log of Trench T 13, Page 1 of 1

07516-42-02.GPJ

SAMPLE SYMBOLS	 ... SAMPLING UNSUCCESSFUL	 ... STANDARD PENETRATION TEST	 ... DRIVE SAMPLE (UNDISTURBED)
	 ... DISTURBED OR BAG SAMPLE	 ... CHUNK SAMPLE	 ... WATER TABLE OR SEEPAGE

NOTE: THE LOG OF SUBSURFACE CONDITIONS SHOWN HEREON APPLIES ONLY AT THE SPECIFIC BORING OR TRENCH LOCATION AND AT THE DATE INDICATED. IT IS NOT WARRANTED TO BE REPRESENTATIVE OF SUBSURFACE CONDITIONS AT OTHER LOCATIONS AND TIMES.









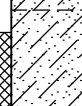

DEPTH IN FEET	SAMPLE NO.	LITHOLOGY	GROUNDWATER	SOIL CLASS (USCS)	TRENCH T 14		PENETRATION RESISTANCE (BLOWS/FT.)	DRY DENSITY (P.C.F.)	MOISTURE CONTENT (%)	
					ELEV. (MSL.) <u>105'</u>	DATE COMPLETED <u>04-15-2005</u>				
					EQUIPMENT <u>JD 305</u> BY: <u>C. JENSEN</u>					
					MATERIAL DESCRIPTION					
0				SM	TOPSOIL Moderately dense, dry to damp, brown, Silty, fine-grained SAND with roots					
2				SC	TERRACE DEPOSIT Moderately dense, moist, dark brown, Clayey, fine-grained SAND with carbonate					
4				SC	Dense, moist, dark brown, Clayey, fine-grained SAND with trace gravel					
6	T14-1			SC						
8				SP	Dense to very dense, damp, brown, Gravelly, fine to medium-grained SAND with cobbles up to 6" diameter, cobbles and gravel subrounded					
10					TRENCH TERMINATED AT 10 FEET					

Figure A-15,
Log of Trench T 14, Page 1 of 1

07516-42-02.GPJ

SAMPLE SYMBOLS	 ... SAMPLING UNSUCCESSFUL	 ... STANDARD PENETRATION TEST	 ... DRIVE SAMPLE (UNDISTURBED)
	 ... DISTURBED OR BAG SAMPLE	 ... CHUNK SAMPLE	 ... WATER TABLE OR SEEPAGE

NOTE: THE LOG OF SUBSURFACE CONDITIONS SHOWN HEREON APPLIES ONLY AT THE SPECIFIC BORING OR TRENCH LOCATION AND AT THE DATE INDICATED. IT IS NOT WARRANTED TO BE REPRESENTATIVE OF SUBSURFACE CONDITIONS AT OTHER LOCATIONS AND TIMES.











DEPTH IN FEET	SAMPLE NO.	LITHOLOGY	GROUNDWATER	SOIL CLASS (USCS)	TRENCH T 15		PENETRATION RESISTANCE (BLOWS/FT.)	DRY DENSITY (P.C.F.)	MOISTURE CONTENT (%)
					ELEV. (MSL.) <u>110'</u>	DATE COMPLETED <u>04-15-2005</u>			
					EQUIPMENT <u>JD 305</u> BY: <u>C. JENSEN</u>				
MATERIAL DESCRIPTION									
0				SM	TOPSOIL Loose to moderately dense, dry to humid, light brown, Silty, fine-grained SAND with roots				
2				SC	TERRACE DEPOSIT Moderately dense, damp to moist, reddish brown, Clayey, fine-grained SAND with micas				
4				SC	Moderately dense to dense, moist, Clayey, fine-grained SAND				
6				SC					
8				CL	Firm to stiff, damp, mottled reddish brown and dark brown, Sandy CLAY				
10					TRENCH TERMINATED AT 10 FEET				

Figure A-16,
Log of Trench T 15, Page 1 of 1

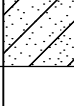
07516-42-02.GPJ

SAMPLE SYMBOLS	 ... SAMPLING UNSUCCESSFUL	 ... STANDARD PENETRATION TEST	 ... DRIVE SAMPLE (UNDISTURBED)
	 ... DISTURBED OR BAG SAMPLE	 ... CHUNK SAMPLE	 ... WATER TABLE OR SEEPAGE

NOTE: THE LOG OF SUBSURFACE CONDITIONS SHOWN HEREON APPLIES ONLY AT THE SPECIFIC BORING OR TRENCH LOCATION AND AT THE DATE INDICATED. IT IS NOT WARRANTED TO BE REPRESENTATIVE OF SUBSURFACE CONDITIONS AT OTHER LOCATIONS AND TIMES.









DEPTH IN FEET	SAMPLE NO.	LITHOLOGY	GROUNDWATER	SOIL CLASS (USCS)	TRENCH T 16		PENETRATION RESISTANCE (BLOWS/FT.)	DRY DENSITY (P.C.F.)	MOISTURE CONTENT (%)
					ELEV. (MSL.) <u>115'</u>	DATE COMPLETED <u>04-15-2005</u>			
					EQUIPMENT <u>JD 305</u>		BY: <u>C. JENSEN</u>		
MATERIAL DESCRIPTION									
0				SM	TOPSOIL Loose to moderately dense, dry to damp, light brown, Silty, fine- grained SAND with roots				
2				SM	TERRACE DEPOSIT Moderately dense, damp, light reddish brown, Silty, fine-grained SAND with carbonate				
4						Moderately dense to dense, moist, dark brown, Clayey, fine-grained SAND			
6				SC					
8									
10									
					TRENCH TERMINATED AT 10 FEET				

Figure A-17,
Log of Trench T 16, Page 1 of 1

07516-42-02.GPJ







SAMPLE SYMBOLS		... SAMPLING UNSUCCESSFUL		... STANDARD PENETRATION TEST		... DRIVE SAMPLE (UNDISTURBED)
		... DISTURBED OR BAG SAMPLE		... CHUNK SAMPLE		... WATER TABLE OR SEEPAGE

NOTE: THE LOG OF SUBSURFACE CONDITIONS SHOWN HEREON APPLIES ONLY AT THE SPECIFIC BORING OR TRENCH LOCATION AND AT THE DATE INDICATED. IT IS NOT WARRANTED TO BE REPRESENTATIVE OF SUBSURFACE CONDITIONS AT OTHER LOCATIONS AND TIMES.

DEPTH IN FEET	SAMPLE NO.	LITHOLOGY	GROUNDWATER	SOIL CLASS (USCS)	TRENCH T 17		PENETRATION RESISTANCE (BLOWS/FT.)	DRY DENSITY (P.C.F.)	MOISTURE CONTENT (%)
					ELEV. (MSL.) 105'	DATE COMPLETED 04-15-2005			
					EQUIPMENT JD 305 BY: C. JENSEN				
MATERIAL DESCRIPTION									
0				SM	TOPSOIL Loose to moderately dense, dry, light brown, Silty, fine-grained SAND with roots				
2				SC	TERRACE DEPOSIT Moderately dense, moist, light reddish brown, Clayey, fine-grained SAND with carbonate				
4	T17-1			SC	Moderately dense to dense, moist, dark brown, Clayey, fine-grained SAND with granitic floater boulders		99.4	18.0	
6									
8				CL	Dense, moist, mottled reddish brown and dark brown Sandy CLAY				
TRENCH TERMINATED AT 8 FEET									

Figure A-18,
Log of Trench T 17, Page 1 of 1

07516-42-02.GPJ

SAMPLE SYMBOLS	 ... SAMPLING UNSUCCESSFUL	 ... STANDARD PENETRATION TEST	 ... DRIVE SAMPLE (UNDISTURBED)
	 ... DISTURBED OR BAG SAMPLE	 ... CHUNK SAMPLE	 ... WATER TABLE OR SEEPAGE

NOTE: THE LOG OF SUBSURFACE CONDITIONS SHOWN HEREON APPLIES ONLY AT THE SPECIFIC BORING OR TRENCH LOCATION AND AT THE DATE INDICATED. IT IS NOT WARRANTED TO BE REPRESENTATIVE OF SUBSURFACE CONDITIONS AT OTHER LOCATIONS AND TIMES.







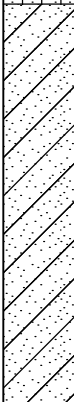

DEPTH IN FEET	SAMPLE NO.	LITHOLOGY	GROUNDWATER	SOIL CLASS (USCS)	TRENCH T 18		PENETRATION RESISTANCE (BLOWS/FT.)	DRY DENSITY (P.C.F.)	MOISTURE CONTENT (%)
					ELEV. (MSL.) <u>110'</u>	DATE COMPLETED <u>04-15-2005</u>			
					EQUIPMENT <u>JD 305</u> BY: <u>C. JENSEN</u>				
MATERIAL DESCRIPTION									
0				SM	TOPSOIL Loose to moderately dense, dry to humid, light brown, Silty SAND with roots				
2				CL	TERRACE DEPOSIT Firm to stiff, damp to moist, dark brown with white specs, Sandy CLAY with carbonate				
4									
6									
8									
10									
12				SP	Dense to very dense, damp, reddish brown, Gravelly, fine to coarse grained SAND, with subrounded gravel and cobbles up to 6" diameter				
TRENCH TERMINATED AT 12 FEET									

Figure A-19,
Log of Trench T 18, Page 1 of 1

07516-42-02.GPJ

SAMPLE SYMBOLS	 ... SAMPLING UNSUCCESSFUL	 ... STANDARD PENETRATION TEST	 ... DRIVE SAMPLE (UNDISTURBED)
	 ... DISTURBED OR BAG SAMPLE	 ... CHUNK SAMPLE	 ... WATER TABLE OR SEEPAGE

NOTE: THE LOG OF SUBSURFACE CONDITIONS SHOWN HEREON APPLIES ONLY AT THE SPECIFIC BORING OR TRENCH LOCATION AND AT THE DATE INDICATED. IT IS NOT WARRANTED TO BE REPRESENTATIVE OF SUBSURFACE CONDITIONS AT OTHER LOCATIONS AND TIMES.











DEPTH IN FEET	SAMPLE NO.	LITHOLOGY	GROUNDWATER	SOIL CLASS (USCS)	TRENCH T 19		PENETRATION RESISTANCE (BLOWS/FT.)	DRY DENSITY (P.C.F.)	MOISTURE CONTENT (%)
					ELEV. (MSL.) <u>105'</u>	DATE COMPLETED <u>04-15-2005</u>			
					EQUIPMENT <u>JD 305</u> BY: <u>C. JENSEN</u>				
MATERIAL DESCRIPTION									
0				SM	TOPSOIL Loose to moderately dense, dry to humid, light brown, Silty SAND with roots				
2	T19-1			CL	TERRACE DEPOSIT Firm to stiff, damp to moist, dark brown with white specs, Sandy CLAY with abundant carbonate		104.0	13.8	
4					Dense, damp, reddish brown, Clayey, fine-grained SAND				
6				SC					
8									
10				SP	Dense to very dense, damp, reddish brown, GRAVELLY, medium-to coarse-grained SAND with subrounded gravels and cobbles up to 4" diameter				
TRENCH TERMINATED AT 10 FEET									

Figure A-20,
Log of Trench T 19, Page 1 of 1

07516-42-02.GPJ

SAMPLE SYMBOLS		... SAMPLING UNSUCCESSFUL		... STANDARD PENETRATION TEST		... DRIVE SAMPLE (UNDISTURBED)
		... DISTURBED OR BAG SAMPLE		... CHUNK SAMPLE		... WATER TABLE OR SEEPAGE

NOTE: THE LOG OF SUBSURFACE CONDITIONS SHOWN HEREON APPLIES ONLY AT THE SPECIFIC BORING OR TRENCH LOCATION AND AT THE DATE INDICATED. IT IS NOT WARRANTED TO BE REPRESENTATIVE OF SUBSURFACE CONDITIONS AT OTHER LOCATIONS AND TIMES.









DEPTH IN FEET	SAMPLE NO.	LITHOLOGY	GROUNDWATER	SOIL CLASS (USCS)	TRENCH T 20		PENETRATION RESISTANCE (BLOWS/FT.)	DRY DENSITY (P.C.F.)	MOISTURE CONTENT (%)
					ELEV. (MSL.) <u>100'</u>	DATE COMPLETED <u>04-15-2005</u>			
					EQUIPMENT <u>JD 305</u>		BY: <u>C. JENSEN</u>		
MATERIAL DESCRIPTION									
0				SM	ARTIFICIAL FILL Loose to moderately dense, dry to humid, light brown, Silty, fine-grained SAND with plastic debris and roots				
2				CL	ALLUVIUM Stiff, damp, dark brown, Sandy CLAY with trace gravel				
4				GP	TERRACE DEPOSIT Dense, damp, dark reddish brown, Clayey Sandy COBBLES with subrounded gravel and cobbles				
6					TRENCH TERMINATED AT 6 FEET				

Figure A-21,
Log of Trench T 20, Page 1 of 1

07516-42-02.GPJ

SAMPLE SYMBOLS	 ... SAMPLING UNSUCCESSFUL	 ... STANDARD PENETRATION TEST	 ... DRIVE SAMPLE (UNDISTURBED)
	 ... DISTURBED OR BAG SAMPLE	 ... CHUNK SAMPLE	 ... WATER TABLE OR SEEPAGE

NOTE: THE LOG OF SUBSURFACE CONDITIONS SHOWN HEREON APPLIES ONLY AT THE SPECIFIC BORING OR TRENCH LOCATION AND AT THE DATE INDICATED. IT IS NOT WARRANTED TO BE REPRESENTATIVE OF SUBSURFACE CONDITIONS AT OTHER LOCATIONS AND TIMES.

DEPTH IN FEET	SAMPLE NO.	LITHOLOGY	GROUNDWATER	SOIL CLASS (USCS)	TRENCH T 21		PENETRATION RESISTANCE (BLOWS/FT.)	DRY DENSITY (P.C.F.)	MOISTURE CONTENT (%)
					ELEV. (MSL.) <u>100'</u>	DATE COMPLETED <u>04-15-2005</u>			
					EQUIPMENT <u>JD 305</u>		BY: <u>C. JENSEN</u>		
MATERIAL DESCRIPTION									
0				SM	ARTIFICIAL FILL Very loose to loose, damp, light reddish brown, Silty SAND with gravel with roots				
2				SC	Loose to moderately dense, moist, mottled dark brown and olive, Clayey SAND				
4				SP	TERRACE DEPOSIT Moderately dense to very dense, moist, reddish brown, Gravelly, medium to coarse-grained SAND with subrounded gravel and cobbles up to 1 foot diameter				
6				TRENCH TERMINATED AT 7 FEET					

Figure A-22,
Log of Trench T 21, Page 1 of 1

07516-42-02.GPJ

SAMPLE SYMBOLS	... SAMPLING UNSUCCESSFUL	... STANDARD PENETRATION TEST	... DRIVE SAMPLE (UNDISTURBED)
	... DISTURBED OR BAG SAMPLE	... CHUNK SAMPLE	... WATER TABLE OR SEEPAGE

NOTE: THE LOG OF SUBSURFACE CONDITIONS SHOWN HEREON APPLIES ONLY AT THE SPECIFIC BORING OR TRENCH LOCATION AND AT THE DATE INDICATED. IT IS NOT WARRANTED TO BE REPRESENTATIVE OF SUBSURFACE CONDITIONS AT OTHER LOCATIONS AND TIMES.

DEPTH IN FEET	SAMPLE NO.	LITHOLOGY	GROUNDWATER	SOIL CLASS (USCS)	TRENCH T 22		PENETRATION RESISTANCE (BLOWS/FT.)	DRY DENSITY (P.C.F.)	MOISTURE CONTENT (%)	
					ELEV. (MSL.) <u>100'</u>	DATE COMPLETED <u>04-15-2005</u>				
					EQUIPMENT <u>JD 305</u>		BY: <u>C. JENSEN</u>			
MATERIAL DESCRIPTION										
0				SM	ARTIFICIAL FILL Loose, dry to damp, brown, Silty SAND with debris greater than 2 feet diameter asphalt concrete curb, brick, plastic and wood					
2										
4										
6										
8				CL	TOPSOIL Firm, moist, black, Sandy CLAY with gravel					
					SP	TERRACE DEPOSIT Dense, moist, reddish brown, Gravelly Cobbly SAND with subrounded gravel and cobbles to 1 foot diameter				
10					TRENCH TERMINATED AT 10 FEET					

Figure A-23,
Log of Trench T 22, Page 1 of 1

07516-42-02.GPJ

SAMPLE SYMBOLS		... SAMPLING UNSUCCESSFUL		... STANDARD PENETRATION TEST		... DRIVE SAMPLE (UNDISTURBED)
		... DISTURBED OR BAG SAMPLE		... CHUNK SAMPLE		... WATER TABLE OR SEEPAGE

NOTE: THE LOG OF SUBSURFACE CONDITIONS SHOWN HEREON APPLIES ONLY AT THE SPECIFIC BORING OR TRENCH LOCATION AND AT THE DATE INDICATED. IT IS NOT WARRANTED TO BE REPRESENTATIVE OF SUBSURFACE CONDITIONS AT OTHER LOCATIONS AND TIMES.











DEPTH IN FEET	SAMPLE NO.	LITHOLOGY	GROUNDWATER	SOIL CLASS (USCS)	TRENCH T 23		PENETRATION RESISTANCE (BLOWS/FT.)	DRY DENSITY (P.C.F.)	MOISTURE CONTENT (%)
					ELEV. (MSL.) <u>100'</u>	DATE COMPLETED <u>04-15-2005</u>			
					EQUIPMENT <u>JD 305</u> BY: <u>C. JENSEN</u>				
MATERIAL DESCRIPTION									
0				CL	ARTIFICIAL FILL Firm, moist, light brown to brown, Sandy CLAY with rock fragments				
2				SC	TOPSOIL Moderately dense, moist, dark brown, Clayey SAND				
4				SC	TERRACE DEPOSIT Moderately dense, reddish brown, Clayey SAND with cobbles and boulders up to 1.5 foot diameter				
6				SM	Dense, damp to moist, reddish brown, Silty, fine to medium grained SAND with cobbles				
TRENCH TERMINATED AT 6 FEET									

Figure A-24,
Log of Trench T 23, Page 1 of 1

07516-42-02.GPJ

SAMPLE SYMBOLS		... SAMPLING UNSUCCESSFUL		... STANDARD PENETRATION TEST		... DRIVE SAMPLE (UNDISTURBED)
		... DISTURBED OR BAG SAMPLE		... CHUNK SAMPLE		... WATER TABLE OR SEEPAGE

NOTE: THE LOG OF SUBSURFACE CONDITIONS SHOWN HEREON APPLIES ONLY AT THE SPECIFIC BORING OR TRENCH LOCATION AND AT THE DATE INDICATED. IT IS NOT WARRANTED TO BE REPRESENTATIVE OF SUBSURFACE CONDITIONS AT OTHER LOCATIONS AND TIMES.

APPENDIX

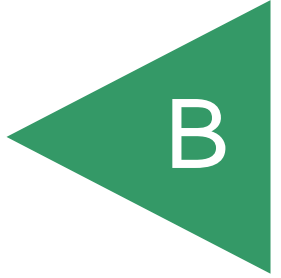

APPENDIX B

LABORATORY TESTING

Laboratory tests were performed in accordance with generally accepted test methods of the American Society for Testing and Materials (ASTM) or other suggested procedures. Selected samples were tested for expansion potential, maximum dry density and optimum moisture content, shear strength characteristics and sulfate content. The results of these tests are summarized on Tables B-I through B-IV.

**TABLE B-I
SUMMARY OF LABORATORY EXPANSION INDEX TEST RESULTS
ASTM D 4829-03**

Sample No.	Moisture Content (%)		Dry Density (pcf)	Expansion Index
	Before Test	After Test		
T1-2	10.4	21.4	108.7	51
T3-2	12.1	23.3	101.9	31
T7-1	10.7	22.5	106.4	49
T12-1	12.8	21.1	100.4	1

**TABLE B-II
SUMMARY OF LABORATORY MAXIMUM DRY DENSITY
AND OPTIMUM MOISTURE CONTENT TEST RESULTS
ASTM D 1557-02**

Sample No.	Description	Maximum Dry Density (pcf)	Optimum Moisture Content (% dry wt.)
T1-2	Light brown, Clayey GRAVEL with little fine to course Sand	132.6	8.2
T3-2	Light yellowish brown fine Sandy SILT with little Clay	120.5	11.9

**TABLE B-III
SUMMARY OF DIRECT SHEAR TEST RESULTS
ASTM D 3080-03**

Sample No.	Dry Density (pcf)	Moisture Content (%)	Unit Cohesion (psf) [ultimate]	Angle of Shear Resistance [ultimate] (degrees)
*T1-2	117.8	9.2	400	18
*T3-2	108.5	11.6	200	36
LD1-2	101.0	14.1	28 [31]	740 [500]
LD1-5	103.1	13.2	29 [28]	900 [870]

* Samples remolded to 90 percent relative density near optimum moisture content.

**TABLE B-IV
SUMMARY OF LABORATORY WATER-SOLUBLE SULFATE TEST RESULTS
CALIFORNIA TEST NO. 417**

Sample No.	Water-Soluble Sulfate(%)	Sulfate Class
T1-2	0.088	S0
T3-2	0.026	S0
T7-1	0.054	S0
T12-1	0.008	S0

SAMPLE NO.: 1-2 GEOLOGIC UNIT: Tmv
 SAMPLE DEPTH (FT): 20' NATURAL/REMOLDED: N

INITIAL CONDITIONS				
NORMAL STRESS TEST LOAD	1 K	2 K	4 K	AVERAGE
ACTUAL NORMAL STRESS (PSF):	890	2030	4300	--
WATER CONTENT (%):	14.5	13.5	14.3	14.1
DRY DENSITY (PCF):	103.2	98.0	101.6	101.0

AFTER TEST CONDITIONS				
NORMAL STRESS TEST LOAD	1 K	2 K	4 K	AVERAGE
WATER CONTENT (%):	22.3	25.1	23.9	23.8
PEAK SHEAR STRESS (PSF):	1310	1750	3050	--
ULT.-E.O.T. SHEAR STRESS (PSF):	983	1760	3101	--

RESULTS		
PEAK	COHESION, C (PSF)	740
	FRICTION ANGLE (DEGREES)	28
ULTIMATE	COHESION, C (PSF)	500
	FRICTION ANGLE (DEGREES)	31

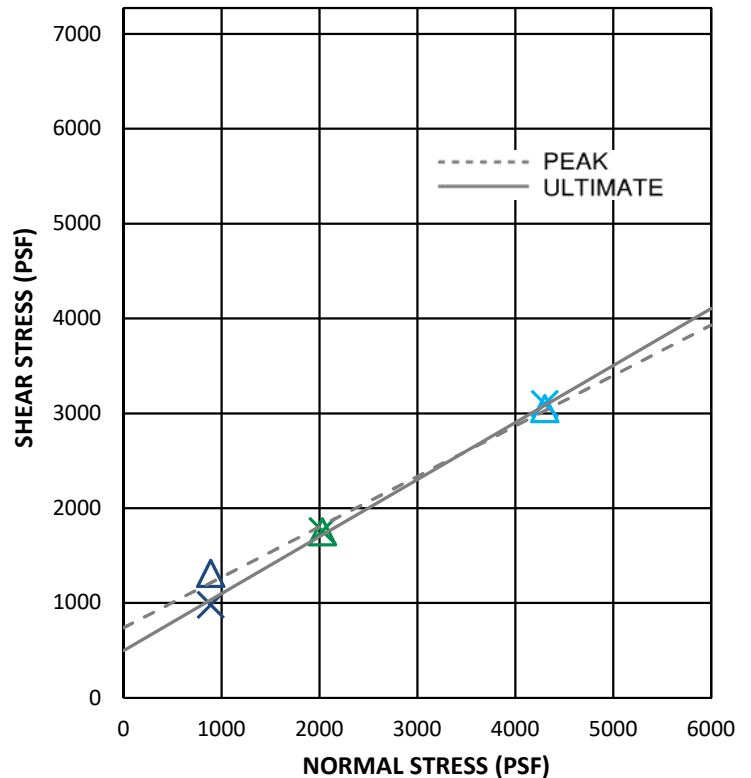
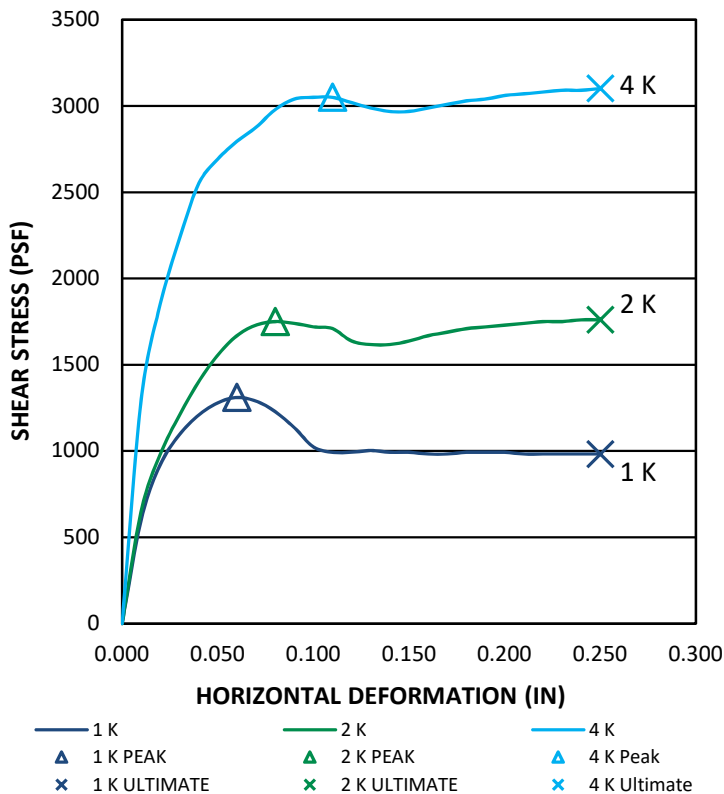

DIRECT SHEAR - ASTM D 3080

GEOCON
INCORPORATED



GEOTECHNICAL CONSULTANTS
 6960 FLANDERS DRIVE - SAN DIEGO, CALIFORNIA 92121-2974
 PHONE 858 558-6900 - FAX 858 558-6159

NAKANO PROPERTY

PROJECT NO.: 7516-42-02

SAMPLE NO.: 1-5 GEOLOGIC UNIT: Tmv
 SAMPLE DEPTH (FT): 50' NATURAL/REMOVED: N

INITIAL CONDITIONS				
NORMAL STRESS TEST LOAD	1 K	2 K	4 K	AVERAGE
ACTUAL NORMAL STRESS (PSF):	890	2030	4300	--
WATER CONTENT (%):	13.0	13.7	12.7	13.2
DRY DENSITY (PCF):	102.8	101.5	104.9	103.1

AFTER TEST CONDITIONS				
NORMAL STRESS TEST LOAD	1 K	2 K	4 K	AVERAGE
WATER CONTENT (%):	22.3	23.6	22.0	22.7
PEAK SHEAR STRESS (PSF):	1341	2159	3234	--
ULT.-E.O.T. SHEAR STRESS (PSF):	1177	2200	3070	--

RESULTS		
PEAK	COHESION, C (PSF)	900
	FRICTION ANGLE (DEGREES)	29
ULTIMATE	COHESION, C (PSF)	870
	FRICTION ANGLE (DEGREES)	28

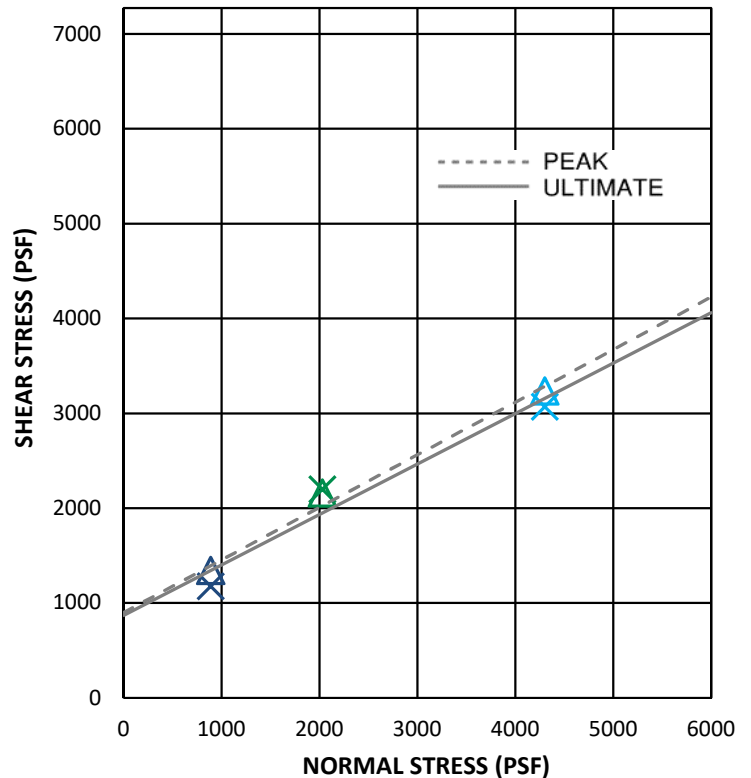
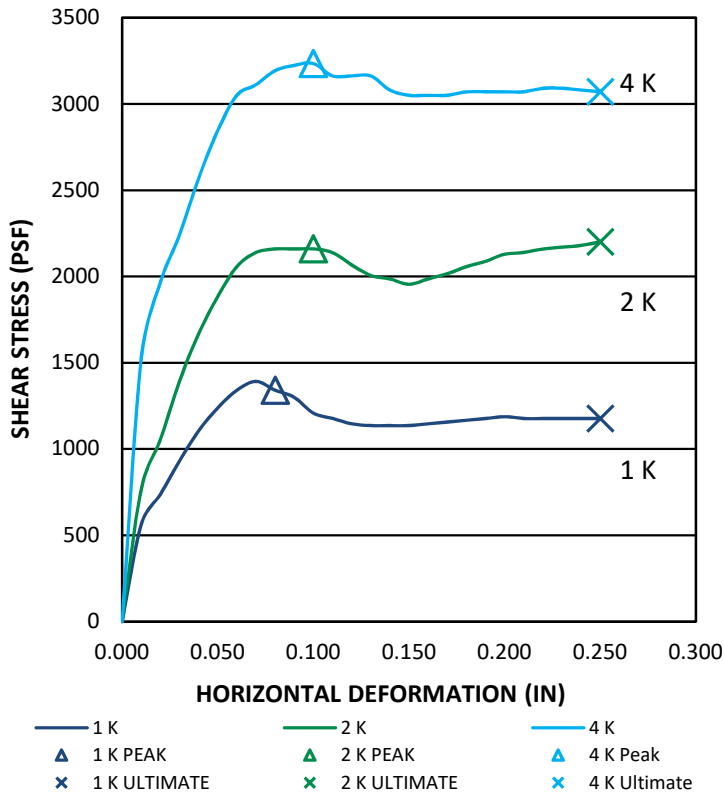

DIRECT SHEAR - ASTM D 3080

GEOCON
INCORPORATED



GEOTECHNICAL CONSULTANTS
 6960 FLANDERS DRIVE - SAN DIEGO, CALIFORNIA 92121-2974
 PHONE 858 558-6900 - FAX 858 558-6159

NAKANO PROPERTY

PROJECT NO.: 7516-42-02

APPENDIX

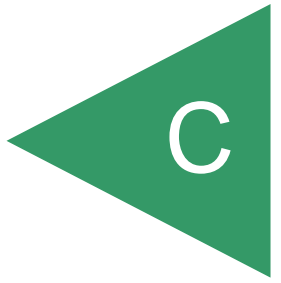

APPENDIX C

STORM WATER MANAGEMENT

We understand storm water management devices are being proposed in accordance with the current Storm Water Standards (SWS). If not properly constructed, there is a potential for distress to improvements and properties located hydrologically down gradient or adjacent to these devices. Factors such as the amount of water to be detained, its residence time, and soil permeability have an important effect on seepage transmission and the potential adverse impacts that may occur if the storm water management features are not properly designed and constructed. We have not performed a hydrogeological study at the site. If infiltration of storm water runoff occurs, downstream properties and improvements may be subjected to seeps, springs, slope instability, raised groundwater, movement of foundations and slabs, or other undesirable impacts as a result of water infiltration.

Hydrologic Soil Group

The United States Department of Agriculture (USDA), Natural Resources Conservation Services, possesses general information regarding the existing soil conditions for areas within the United States. The USDA website also provides the Hydrologic Soil Group. Table C-1 presents the descriptions of the hydrologic soil groups. In addition, the USDA website also provides an estimated saturated hydraulic conductivity for the existing soil.

**TABLE C-1
HYDROLOGIC SOIL GROUP DEFINITIONS**

Soil Group	Soil Group Definition
A	Soils having a high infiltration rate (low runoff potential) when thoroughly wet. These consist mainly of deep, well drained to excessively drained sands or gravelly sands. These soils have a high rate of water transmission.
B	Soils having a moderate infiltration rate when thoroughly wet. These consist chiefly of moderately deep or deep, moderately well drained or well drained soils that have moderately fine texture to moderately coarse texture. These soils have a moderate rate of water transmission.
C	Soils having a slow infiltration rate when thoroughly wet. These consist chiefly of soils having a layer that impedes the downward movement of water or soils of moderately fine texture or fine texture. These soils have a slow rate of water transmission.
D	Soils having a very slow infiltration rate (high runoff potential) when thoroughly wet. These consist chiefly of clays that have a high shrink-swell potential, soils that have a high water table, soils that have a claypan or clay layer at or near the surface, and soils that are shallow over nearly impervious material. These soils have a very slow rate of water transmission.

The property is underlain by undocumented fill, surficial deposits such as topsoil, colluvium and alluvium, Terrace Deposits, and the Mission Valley Formation. Table C-2 presents the information from the USDA website for the subject property.

**TABLE C-2
USDA WEB SOIL SURVEY – HYDROLOGIC SOIL GROUP**

Map Unit Name	Map Unit Symbol	Approximate Percentage of Property	Hydrologic Soil Group
Olivenhain cobbly loam, 9 to 30 percent slopes	OhE	5.0	D
Riverwash	Rm	18.5	D
Salinas clay loam, 0 to 2 percent slopes, warm MAAT, MLRA 19	SbA	76.6	C

Infiltration Testing

We performed two borehole infiltration tests at the locations shown on Figure 2. The tests were performed in 8-inch-diameter, drilled borings. Table C-3 presents the results of the testing. The calculation sheets are provided herein.

We used the guidelines presented in the Riverside County Low Impact Development BMP Design Handbook. Based on this widely accepted guideline, the saturated hydraulic conductivity (Ksat) is equivalent to the infiltration rate. Therefore, the Ksat value determined from our testing is assumed to be the unfactored infiltration rate.

**TABLE C-3
UNFACTORED, FIELD-SATURATED, INFILTRATION TEST RESULTS**

Test No.	Depth (inches)	Geologic Unit	Field Infiltration Rate, I (in/hr)	Factored* Field Infiltration Rate, I (in/hr)
A-1	68	Qudf	0.004	0.002
A-2	92	Qudf	0.244	0.12

* Factor of Safety of 2.0 for feasibility determination.

STORM WATER MANAGEMENT CONCLUSIONS

Soil Types

Undocumented Fill (Qpudf) – We encountered undocumented fill up to 18 feet thick at the north end of the property. The undocumented fill within structural improvement areas will be removed and replaced with compacted fill. Water that is allowed to migrate into the undocumented fill or

compacted fill will cause settlement. Therefore, full and partial infiltration should be considered infeasible within fill.

Topsoil (Unmapped) – We encountered topsoil varying between 0.5 and 3 feet thick across the site. Topsoil within structural improvement areas will be removed and replaced with compacted fill. Water that is allowed to migrate into the topsoil will cause settlement. Therefore, full and partial infiltration should be considered infeasible within topsoil.

Colluvium (Qcol) – We encountered colluvium on the north-facing slopes at the south property boundary, varying between 0.5 and 5 feet thick. Colluvium within structural improvement areas will be removed and replaced with compacted fill. Water that is allowed to migrate into colluvium will cause settlement. Therefore, full and partial infiltration should be considered infeasible within areas underlain by colluvium.

Alluvium (Qal) – Alluvium is present in a drainage located at the southeast corner of the property. Alluvium was also encountered in Trench T-20 beneath undocumented fill at the north end of the site. Alluvium within structural improvement areas will be removed and replaced with compacted fill. Water that is allowed to migrate into alluvium will cause settlement. Therefore, full and partial infiltration should be considered infeasible within areas underlain by alluvium.

Terrace Deposits (Qt) – We encountered Terrace Deposits underlying most of the site below the artificial fill, topsoil, and alluvium. Infiltration into Terrace Deposits may be possible.

Mission Valley Formation (Tmv) – We encountered age Mission Valley in slopes along the southern portion of the site. Mission Valley Formation may also be present underlying the Terrace Deposits in the central portion of the site. Infiltration into the Mission Valley Formation is not feasible due to low infiltration characteristics.

Groundwater Elevation

Groundwater was not encountered in our borings or trenches to a depths explored. Infiltration should not impact groundwater.

Existing Utilities

Existing utilities are located on the north side of the property and along the west and east property margins. Infiltration near these utilities is considered infeasible. Otherwise, infiltration due to utility concerns would be feasible.

Soil or Groundwater Contamination

We are unaware of contaminated soil or groundwater on the property. Therefore, full and partial infiltration associated with this risk is considered feasible.

Slopes

There are no existing slopes that would be impacted by infiltration. There are proposed fill slopes where infiltration adjacent to the slopes is not feasible.

Infiltration Rates

Our test results indicated slow infiltration rates. The factored rates were 0.002 and 0.12 inches per hour. The infiltration rates are not high enough to support full or partial infiltration in the area of the proposed BMP.

Storm Water Management Devices

Liners should be incorporated in the proposed basin. The liner should be impermeable (e.g. High-density polyethylene, HDPE, with a thickness of about 30 mil or equivalent Polyvinyl Chloride, PVC). Penetration of the liners should be properly sealed. The devices should also be installed in accordance with the manufacturer's recommendations. Overflow protection devices should also be incorporated into the design and construction of the storm water management device.

Storm Water Standard Worksheets

The SWS requests the geotechnical engineer complete the *Categorization of Infiltration Feasibility Condition* (Worksheet C.4-1) worksheet information to help evaluate the potential for infiltration on the property. The attached Worksheet C.4-1 presents the completed information for the submittal process.

The regional storm water standards also have a worksheet (Worksheet Form D.5-1) that helps the project civil engineer estimate the factor of safety based on several factors. Table C-4 describes the suitability assessment input parameters related to the geotechnical engineering aspects for the factor of safety determination.

**TABLE C-4
SUITABILITY ASSESSMENT RELATED CONSIDERATIONS FOR INFILTRATION FACILITY
SAFETY FACTORS**

Consideration	High Concern – 3 Points	Medium Concern – 2 Points	Low Concern – 1 Point
Assessment Methods	Use of soil survey maps or simple texture analysis to estimate short-term infiltration rates. Use of well permeameter or borehole methods without accompanying continuous boring log. Relatively sparse testing with direct infiltration methods	Use of well permeameter or borehole methods with accompanying continuous boring log. Direct measurement of infiltration area with localized infiltration measurement methods (e.g., Infiltrometer). Moderate spatial resolution	Direct measurement with localized (i.e. small-scale) infiltration testing methods at relatively high resolution or use of extensive test pit infiltration measurement methods.
Predominant Soil Texture	Silty and clayey soils with significant fines	Loamy soils	Granular to slightly loamy soils
Site Soil Variability	Highly variable soils indicated from site assessment or unknown variability	Soil boring/test pits indicate moderately homogenous soils	Soil boring/test pits indicate relatively homogenous soils
Depth to Groundwater/ Impervious Layer	<5 feet below facility bottom	5-15 feet below facility bottom	>15 feet below facility bottom

Table C-5 presents the estimated factor values for the evaluation of the factor of safety. This table only presents the suitability assessment safety factor (Part A) of the worksheet. The project civil engineer should evaluate the safety factor for design (Part B) and use the combined safety factor for the design infiltration rate.

**TABLE C-5
FACTOR OF SAFETY WORKSHEET D.5-1 DESIGN VALUES¹**

Suitability Assessment Factor Category	Assigned Weight (w)	Factor Value (v)	Product (p = w x v)
Assessment Methods	0.25	2	0.50
Predominant Soil Texture	0.25	3	0.75
Site Soil Variability	0.25	2	0.50
Depth to Groundwater/Impervious Layer	0.25	1	0.25
Suitability Assessment Safety Factor, $S_A = \Sigma p$			2.0

¹ The project civil engineer should complete Worksheet D.5-1 using the data on this table. Additional information is required to evaluate the design factor of safety.

CONCLUSIONS

Our results indicate the site has relatively slow infiltration characteristics. Because of the site conditions, it is our opinion that there is a potential for lateral water migration. Undocumented and previously placed fill exists on the property and has a high potential for adverse settlement when wetted. It is our opinion that full or partial infiltration is infeasible on this site. Our evaluation included the soil and geologic conditions, estimated settlement and volume change of the underlying soil, slope stability, utility considerations, groundwater mounding, retaining walls, foundations and existing groundwater elevations.



Aardvark Permeameter Data Analysis

Project Name: Nakano
 Project Number: 07516-42-02
 Test Number: A-1

Date: 12/20/2019
 By: BRK

Borehole Diameter, d (in.): 8.00
 Borehole Depth, H (in.): 68.00
 Distance Between Reservoir & Top of Borehole (in.): 26.00
 Height APM Raised from Bottom (in.): 2.00
 Pressure Reducer Used: No

Ref. EL (feet, MSL): 102.0
 Bottom EL (feet, MSL): 96.3

Distance Between Reservoir and APM Float, D (in.): 84.75
 Head Height Measured, h (in.): 5.50

Reading	Time Elapsed (min)	Water Weight Consumed (lbs)	Water Volume Consumed (in ³)	Q (in ³ /min)
1	0.00	0.000	0.00	0.00
2	5.00	11.530	319.29	63.858
3	5.00	1.665	46.11	9.222
4	5.00	0.155	4.29	0.858
5	5.00	0.045	1.25	0.249
6	5.00	0.045	1.25	0.249
7	5.00	0.035	0.97	0.194
8	5.00	0.035	0.97	0.194
9	10.00	0.045	1.25	0.125
10	10.00	0.045	1.25	0.125
11	10.00	0.030	0.83	0.083
12	10.00	0.025	0.69	0.069
13	10.00	0.020	0.55	0.055
14	10.00	0.015	0.42	0.042
15	10.00	0.015	0.42	0.042

Steady Flow Rate, Q (in³/min): 0.046

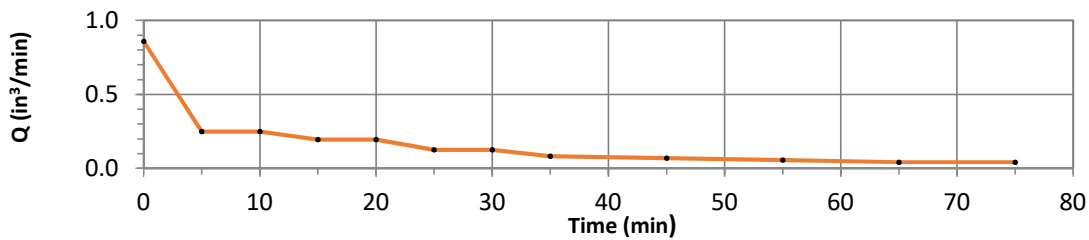

Soil Matric Flux Potential, ϕ_m

$\phi_m =$ 0.00060 in²/min

Field-Saturated Hydraulic Conductivity (Infiltration Rate)

$K_{sat} =$ 6.07E-05 in/min 0.004 in/hr



Borehole Infiltration Test

Project Name: Nakano
 Project Number: 07516-42-02
 Test Number: A-2

Date: 12/20/2019
 By: BRK
 Ref. EL (feet, MSL): 100.0
 Bottom EL (feet, MSL): 92.3

Borehole Diameter, d (in.): 8.00
 Borehole Depth, H (in.): 92.00
 Distance Between Reservoir & Top of Borehole (in.): 26.00
 Height APM Raised from Bottom (in.): 2.00
 Pressure Reducer Used: No

Distance Between Reservoir and APM Float, D (in.): 108.75
 Head Height Measured, h (in.): 4.75

Reading	Time Elapsed (min)	Water Weight Consummed (lbs)	Water Volume Consummed (in ³)	Q (in ³ /min)
1	0.00	0.000	0.00	0.00
2	5.00	11.255	311.68	62.335
3	5.00	1.095	30.32	6.065
4	5.00	0.315	8.72	1.745
5	5.00	0.995	27.55	5.511
6	5.00	1.075	29.77	5.954
7	5.00	0.985	27.28	5.455
8	5.00	0.915	25.34	5.068
9	5.00	0.890	24.65	4.929
10	5.00	0.845	23.40	4.680
11	5.00	0.770	21.32	4.265
12	5.00	0.740	20.49	4.098
13	5.00	0.695	19.25	3.849
14	5.00	0.665	18.42	3.683
15	5.00	0.655	18.14	3.628
16	6.00	0.750	20.77	3.462
17	4.00	0.440	12.18	3.046
18	5.00	0.565	15.65	3.129
19	5.00	0.535	14.82	2.963
20	5.00	0.530	14.68	2.935
21	5.00	0.510	14.12	2.825
22	6.00	0.610	16.89	2.815
23	4.00	0.405	11.22	2.804
Steady Flow Rate, Q (in ³ /min):				2.815

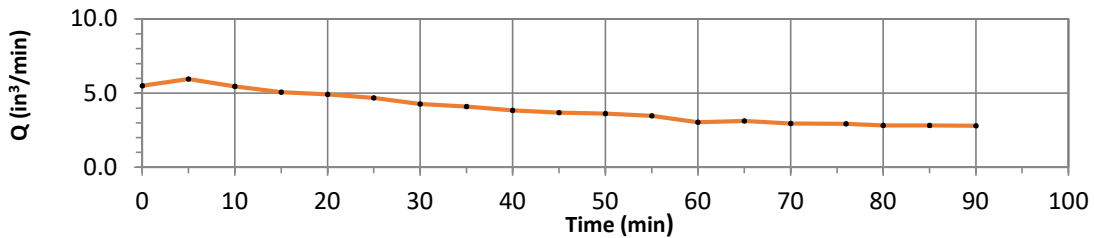

Soil Matric Flux Potential, ϕ_m

$\phi_m =$ 0.0538 in²/min

Field-Saturated Hydraulic Conductivity (Infiltration Rate)

$K_{sat} =$ 1.37E-03 in/min 0.082 in/hr

Project Name: _____

Categorization of Infiltration Feasibility Condition based on Geotechnical Conditions		Form I-8A ¹ (Worksheet C.4-1)
Part 1 - Full Infiltration Feasibility Screening Criteria		
DMA(s) Being Analyzed:		Project Phase:
Entire Site		Planning
Criteria 1: Infiltration Rate Screening		
1A	<p>Is the mapped hydrologic soil group according to the NRCS Web Soil Survey or UC Davis Soil Web Mapper Type A or B and corroborated by available site soil data²?</p> <p><input type="checkbox"/> Yes; the DMA may feasibly support full infiltration. Answer “Yes” to Criteria 1 Result or continue to Step 1B if the applicant elects to perform infiltration testing.</p> <p><input type="checkbox"/> No; the mapped soil types are A or B but is not corroborated by available site soil data (continue to Step 1B).</p> <p><input checked="" type="checkbox"/> No; the mapped soil types are C, D, or “urban/unclassified” and is corroborated by available site soil data. Answer “No” to Criteria 1 Result.</p> <p><input type="checkbox"/> No; the mapped soil types are C, D, or “urban/unclassified” but is not corroborated by available site soil data (continue to Step 1B).</p>	
1B	<p>Is the reliable infiltration rate calculated using planning phase methods from Table D.3-1?</p> <p><input checked="" type="checkbox"/> Yes; Continue to Step 1C.</p> <p><input type="checkbox"/> No; Skip to Step 1D.</p>	
1C	<p>Is the reliable infiltration rate calculated using planning phase methods from Table D.3-1 greater than 0.5 inches per hour?</p> <p><input type="checkbox"/> Yes; the DMA may feasibly support full infiltration. Answer “Yes” to Criteria 1 Result.</p> <p><input checked="" type="checkbox"/> No; full infiltration is not required. Answer “No” to Criteria 1 Result.</p>	
1D	<p>Infiltration Testing Method. Is the selected infiltration testing method suitable during the design phase (see Appendix D.3)? Note: Alternative testing standards may be allowed with appropriate rationales and documentation.</p> <p><input type="checkbox"/> Yes; continue to Step 1E.</p> <p><input type="checkbox"/> No; select an appropriate infiltration testing method.</p>	
1E	<p>Number of Percolation/Infiltration Tests. Does the infiltration testing method performed satisfy the minimum number of tests specified in Table D.3-2?</p> <p><input type="checkbox"/> Yes; continue to Step 1F.</p> <p><input type="checkbox"/> No; conduct appropriate number of tests.</p>	

¹ This form must be completed each time there is a change to the site layout that would affect the infiltration feasibility condition. Previously completed forms shall be retained to document the evolution of the site storm water design.

² Available data includes site-specific sampling or observation of soil types or texture classes, such as obtained from borings or test pits necessary to support other design elements.



Project Name: _____

Categorization of Infiltration Feasibility Condition based on Geotechnical Conditions		Form I-8A ¹ (Worksheet C.4-1)
IF	<p>Factor of Safety. Is the suitable Factor of Safety selected for full infiltration design? See guidance in D.5; Tables D.5-1 and D.5-2; and Worksheet D.5-1 (Form I-9).</p> <p><input type="checkbox"/> Yes; continue to Step 1G. <input type="checkbox"/> No; select appropriate factor of safety.</p>	
1G	<p>Full Infiltration Feasibility. Is the average measured infiltration rate divided by the Factor of Safety greater than 0.5 inches per hour?</p> <p><input type="checkbox"/> Yes; answer “Yes” to Criteria 1 Result. <input type="checkbox"/> No; answer “No” to Criteria 1 Result.</p>	
Criteria 1 Result	<p>Is the estimated reliable infiltration rate greater than 0.5 inches per hour within the DMA where runoff can reasonably be routed to a BMP?</p> <p><input type="checkbox"/> Yes; the DMA may feasibly support full infiltration. Continue to Criteria 2. <input checked="" type="checkbox"/> No; full infiltration is not required. Skip to Part 1 Result.</p>	
<p>Summarize infiltration testing methods, testing locations, replicates, and results and summarize estimates of reliable infiltration rates according to procedures outlined in D.5. Documentation should be included in project geotechnical report.</p> <p>Infiltration was performed at two locations within the project site using borehole infiltration tests. The test results were as follows:</p> <p>A-1: 0.004 in/hr (0.002 in/hr using a factor of safety of 2.0 for feasibility determination) A-2: 0.082 in/hr (0.041 in/hr using a factor of safety of 2.0 for feasibility determination)</p> <p>Infiltration test information is contained in the geotechnical investigation dated September 18, 2020.</p>		
Criteria 2: Geologic/Geotechnical Screening		
2A	<p>If all questions in Step 2A are answered “Yes,” continue to Step 2B.</p> <p>For any “No” answer in Step 2A answer “No” to Criteria 2 and submit an “Infiltration Feasibility Condition Letter” that meets the requirements in Appendix C.1.1.</p> <p>The geologic/geotechnical analyses listed in Appendix C.2.1 do not apply to the DMA because one of the following setbacks cannot be avoided and therefore result in the DMA being in a no infiltration condition. The setbacks must be the closest horizontal radial distance from the surface edge (at the overflow elevation) of the BMP.</p>	



Project Name: _____

Categorization of Infiltration Feasibility Condition based on Geotechnical Conditions		Form I-8A ¹ (Worksheet C.4-1)	
2A-1	Can the proposed full infiltration BMP(s) avoid areas with existing fill materials greater than 5 feet thick below the infiltrating surface?	<input type="checkbox"/> Yes	<input type="checkbox"/> No
2A-2	Can the proposed full infiltration BMP(s) avoid placement within 10 feet of existing underground utilities, structures, or retaining walls?	<input type="checkbox"/> Yes	<input type="checkbox"/> No
2A-3	Can the proposed full infiltration BMP(s) avoid placement within 50 feet of a natural slope (>25%) or within a distance of 1.5H from fill slopes where H is the height of the fill slope?	<input type="checkbox"/> Yes	<input type="checkbox"/> No
2B	When full infiltration is determined to be feasible, a geotechnical investigation report must be prepared that considers the relevant factors identified in Appendix C.2.1. If all questions in Step 2B are answered “Yes,” then answer “Yes” to Criteria 2 Result. If there are “No” answers continue to Step 2C.		
2B-1	Hydroconsolidation. Analyze hydroconsolidation potential per approved ASTM standard due to a proposed full infiltration BMP. Can full infiltration BMPs be proposed within the DMA without increasing hydroconsolidation risks?	<input type="checkbox"/> Yes	<input type="checkbox"/> No
2B-2	Expansive Soils. Identify expansive soils (soils with an expansion index greater than 20) and the extent of such soils due to proposed full infiltration BMPs. Can full infiltration BMPs be proposed within the DMA without increasing expansive soil risks?	<input type="checkbox"/> Yes	<input type="checkbox"/> No
2B-3	Liquefaction. If applicable, identify mapped liquefaction areas. Evaluate liquefaction hazards in accordance with Section 6.4.2 of the City of San Diego's Guidelines for Geotechnical Reports (2011 or most recent edition). Liquefaction hazard assessment shall take into account any increase in groundwater elevation or groundwater mounding that could occur as a result of proposed infiltration or percolation facilities. Can full infiltration BMPs be proposed within the DMA without increasing liquefaction risks?	<input type="checkbox"/> Yes	<input type="checkbox"/> No
2B-4	Slope Stability. If applicable, perform a slope stability analysis in accordance with the ASCE and Southern California Earthquake Center (2002) Recommended Procedures for Implementation of DMG Special Publication 117, Guidelines for Analyzing and Mitigating Landslide Hazards in California to determine minimum slope setbacks for full infiltration BMPs. See the City of San Diego's Guidelines for Geotechnical Reports (2011) to determine which type of slope stability analysis is required. Can full infiltration BMPs be proposed within the DMA without increasing slope stability risks?	<input type="checkbox"/> Yes	<input type="checkbox"/> No
2B-5	Other Geotechnical Hazards. Identify site-specific geotechnical hazards not already mentioned (refer to Appendix C.2.1). Can full infiltration BMPs be proposed within the DMA without increasing risk of geologic or geotechnical hazards not already mentioned?	<input type="checkbox"/> Yes	<input type="checkbox"/> No

Project Name: _____

Categorization of Infiltration Feasibility Condition based on Geotechnical Conditions		Form I-8A ¹ (Worksheet C.4-1)	
2B-6	<p>Setbacks. Establish setbacks from underground utilities, structures, and/or retaining walls. Reference applicable ASTM or other recognized standard in the geotechnical report.</p> <p>Can full infiltration BMPs be proposed within the DMA using established setbacks from underground utilities, structures, and/or retaining walls?</p>	<input type="checkbox"/> Yes	<input type="checkbox"/> No
2C	<p>Mitigation Measures. Propose mitigation measures for each geologic/geotechnical hazard identified in Step 2B. Provide a discussion of geologic/geotechnical hazards that would prevent full infiltration BMPs that cannot be reasonably mitigated in the geotechnical report. See Appendix C.2.1.8 for a list of typically reasonable and typically unreasonable mitigation measures.</p> <p>Can mitigation measures be proposed to allow for full infiltration BMPs? If the question in Step 2 is answered “Yes,” then answer “Yes” to Criteria 2 Result.</p> <p>If the question in Step 2C is answered “No,” then answer “No” to Criteria 2 Result.</p>	<input type="checkbox"/> Yes	<input type="checkbox"/> No
Criteria 2 Result	Can infiltration greater than 0.5 inches per hour be allowed without increasing risk of geologic or geotechnical hazards that cannot be reasonably mitigated to an acceptable level?	<input type="checkbox"/> Yes	<input type="checkbox"/> No
Summarize findings and basis; provide references to related reports or exhibits.			
Part 1 Result – Full Infiltration Geotechnical Screening ³		Result	
<p>If answers to both Criteria 1 and Criteria 2 are “Yes”, a full infiltration design is potentially feasible based on Geotechnical conditions only.</p> <p>If either answer to Criteria 1 or Criteria 2 is “No”, a full infiltration design is not required.</p>		<input type="checkbox"/> Full infiltration Condition <input checked="" type="checkbox"/> Complete Part 2	

³ To be completed using gathered site information and best professional judgement considering the definition of MEP in the MS4 Permit. Additional testing and/or studies may be required by City Engineer to substantiate findings.



Project Name: _____

Categorization of Infiltration Feasibility Condition based on Geotechnical Conditions		Form I-8A ¹ (Worksheet C.4-1)
Part 2 – Partial vs. No Infiltration Feasibility Screening Criteria		
DMA(s) Being Analyzed:		Project Phase:
Entire Site		Planning
Criteria 3 : Infiltration Rate Screening		
3A	<p>NRCS Type C, D, or “urban/unclassified”: Is the mapped hydrologic soil group according to the NRCS Web Soil Survey or UC Davis Soil Web Mapper is Type C, D, or “urban/unclassified” and corroborated by available site soil data?</p> <p><input type="checkbox"/> Yes; the site is mapped as C soils and a reliable infiltration rate of 0.15 in/hr. is used to size partial infiltration BMPS. Answer “Yes” to Criteria 3 Result.</p> <p><input type="checkbox"/> Yes; the site is mapped as D soils or “urban/unclassified” and a reliable infiltration rate of 0.05 in/hr. is used to size partial infiltration BMPS. Answer “Yes” to Criteria 3 Result.</p> <p><input checked="" type="checkbox"/> No; infiltration testing is conducted (refer to Table D.3-1), continue to Step 3B.</p>	
3B	<p>Infiltration Testing Result: Is the reliable infiltration rate (i.e. average measured infiltration rate/2) greater than 0.05 in/hr. and less than or equal to 0.5 in/hr?</p> <p><input type="checkbox"/> Yes; the site may support partial infiltration. Answer “Yes” to Criteria 3 Result.</p> <p><input checked="" type="checkbox"/> No; the reliable infiltration rate (i.e. average measured rate/2) is less than 0.05 in/hr., partial infiltration is not required. Answer “No” to Criteria 3 Result.</p>	
Criteria 3 Result	<p>Is the estimated reliable infiltration rate (i.e., average measured infiltration rate/2) greater than or equal to 0.05 inches/hour and less than or equal to 0.5 inches/hour at any location within each DMA where runoff can reasonably be routed to a BMP?</p> <p><input type="checkbox"/> Yes; Continue to Criteria 4.</p> <p><input checked="" type="checkbox"/> No: Skip to Part 2 Result.</p>	
<p>Summarize infiltration testing and/or mapping results (i.e. soil maps and series description used for infiltration rate).</p> <p>Infiltration testing was performed in the area of the proposed storm water BMP at the northwest corner of the property. The test results were as follows:</p> <p>A-1: 0.004 in/hr (0.002 in/hr using a factor of safety of 2.0 for feasibility determination) A-2: 0.082 in/hr (0.041 in/hr using a factor of safety of 2.0 for feasibility determination)</p> <p>This rate is not fast enough for partial infiltration.</p> <p>Infiltration test information is contained in the geotechnical investigation dated September 18, 2020.</p>		

Project Name: _____

Categorization of Infiltration Feasibility Condition based on Geotechnical Conditions		Form I-8A ¹ (Worksheet C.4-1)	
Criteria 4: Geologic/Geotechnical Screening			
4A	<p>If all questions in Step 4A are answered “Yes,” continue to Step 2B.</p> <p>For any “No” answer in Step 4A answer “No” to Criteria 4 Result, and submit an “Infiltration Feasibility Condition Letter” that meets the requirements in Appendix C.1.1. The geologic/geotechnical analyses listed in Appendix C.2.1 do not apply to the DMA because one of the following setbacks cannot be avoided and therefore result in the DMA being in a no infiltration condition. The setbacks must be the closest horizontal radial distance from the surface edge (at the overflow elevation) of the BMP.</p>		
4A-1	Can the proposed partial infiltration BMP(s) avoid areas with existing fill materials greater than 5 feet thick?	<input type="checkbox"/> Yes	<input type="checkbox"/> No
4A-2	Can the proposed partial infiltration BMP(s) avoid placement within 10 feet of existing underground utilities, structures, or retaining walls?	<input type="checkbox"/> Yes	<input type="checkbox"/> No
4A-3	Can the proposed partial infiltration BMP(s) avoid placement within 50 feet of a natural slope (>25%) or within a distance of 1.5H from fill slopes where H is the height of the fill slope?	<input type="checkbox"/> Yes	<input type="checkbox"/> No
4B	<p>When full infiltration is determined to be feasible, a geotechnical investigation report must be prepared that considers the relevant factors identified in Appendix C.2.1.</p> <p>If all questions in Step 4B are answered “Yes,” then answer “Yes” to Criteria 4 Result. If there are any “No” answers continue to Step 4C.</p>		
4B-1	<p>Hydroconsolidation. Analyze hydroconsolidation potential per approved ASTM standard due to a proposed full infiltration BMP.</p> <p>Can partial infiltration BMPs be proposed within the DMA without increasing hydroconsolidation risks?</p>	<input type="checkbox"/> Yes	<input type="checkbox"/> No
4B-2	<p>Expansive Soils. Identify expansive soils (soils with an expansion index greater than 20) and the extent of such soils due to proposed full infiltration BMPs.</p> <p>Can partial infiltration BMPs be proposed within the DMA without increasing expansive soil risks?</p>	<input type="checkbox"/> Yes	<input type="checkbox"/> No
4B-3	<p>Liquefaction. If applicable, identify mapped liquefaction areas. Evaluate liquefaction hazards in accordance with Section 6.4.2 of the City of San Diego's Guidelines for Geotechnical Reports (2011). Liquefaction hazard assessment shall take into account any increase in groundwater elevation or groundwater mounding that could occur as a result of proposed infiltration or percolation facilities.</p> <p>Can partial infiltration BMPs be proposed within the DMA without increasing liquefaction risks?</p>	<input type="checkbox"/> Yes	<input type="checkbox"/> No



Project Name: _____

Categorization of Infiltration Feasibility Condition based on Geotechnical Conditions		Form I-8A ¹ (Worksheet C.4-1)	
4B-4	<p>Slope Stability. If applicable, perform a slope stability analysis in accordance with the ASCE and Southern California Earthquake Center (2002) Recommended Procedures for Implementation of DMG Special Publication 117, Guidelines for Analyzing and Mitigating Landslide Hazards in California to determine minimum slope setbacks for full infiltration BMPs. See the City of San Diego's Guidelines for Geotechnical Reports (2011) to determine which type of slope stability analysis is required.</p> <p>Can partial infiltration BMPs be proposed within the DMA without increasing slope stability risks?</p>	<input type="checkbox"/> Yes	<input type="checkbox"/> No
4B-5	<p>Other Geotechnical Hazards. Identify site-specific geotechnical hazards not already mentioned (refer to Appendix C.2.1).</p> <p>Can partial infiltration BMPs be proposed within the DMA without increasing risk of geologic or geotechnical hazards not already mentioned?</p>	<input type="checkbox"/> Yes	<input type="checkbox"/> No
4B-6	<p>Setbacks. Establish setbacks from underground utilities, structures, and/or retaining walls. Reference applicable ASTM or other recognized standard in the geotechnical report.</p> <p>Can partial infiltration BMPs be proposed within the DMA using recommended setbacks from underground utilities, structures, and/or retaining walls?</p>	<input type="checkbox"/> Yes	<input type="checkbox"/> No
4C	<p>Mitigation Measures. Propose mitigation measures for each geologic/geotechnical hazard identified in Step 4B. Provide a discussion on geologic/geotechnical hazards that would prevent partial infiltration BMPs that cannot be reasonably mitigated in the geotechnical report. See Appendix C.2.1.8 for a list of typically reasonable and typically unreasonable mitigation measures.</p> <p>Can mitigation measures be proposed to allow for partial infiltration BMPs? If the question in Step 4C is answered "Yes," then answer "Yes" to Criteria 4 Result.</p> <p>If the question in Step 4C is answered "No," then answer "No" to Criteria 4 Result.</p>	<input type="checkbox"/> Yes	<input type="checkbox"/> No
Criteria 4 Result	<p>Can infiltration of greater than or equal to 0.05 inches/hour and less than or equal to 0.5 inches/hour be allowed without increasing the risk of geologic or geotechnical hazards that cannot be reasonably mitigated to an acceptable level?</p>	<input type="checkbox"/> Yes	<input type="checkbox"/> No

Project Name: _____

Categorization of Infiltration Feasibility Condition based on Geotechnical Conditions	Form I-8A ¹ (Worksheet C.4-1)
<p>Summarize findings and basis; provide references to related reports or exhibits.</p>	
Part 2 – Partial Infiltration Geotechnical Screening Result ⁴	Result
<p>If answers to both Criteria 3 and Criteria 4 are “Yes”, a partial infiltration design is potentially feasible based on geotechnical conditions only.</p> <p>If answers to either Criteria 3 or Criteria 4 is “No”, then infiltration of any volume is considered to be infeasible within the site.</p>	<p><input type="checkbox"/> Partial Infiltration Condition</p> <p><input checked="" type="checkbox"/> No Infiltration Condition</p>

⁴ To be completed using gathered site information and best professional judgement considering the definition of MEP in the MS4 Permit. Additional testing and/or studies may be required by City Engineer to substantiate findings.

APPENDIX

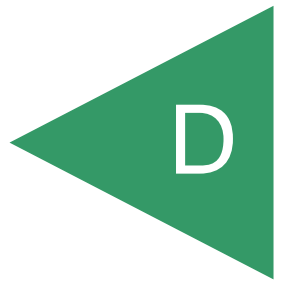

APPENDIX D

RECOMMENDED GRADING SPECIFICATIONS

FOR

NAKANO PROPERTY
CHULA VISTA, CALIFORNIA

PROJECT NO. 07516-42-02

RECOMMENDED GRADING SPECIFICATIONS

1. GENERAL

- 1.1 These Recommended Grading Specifications shall be used in conjunction with the Geotechnical Report for the project prepared by Geocon. The recommendations contained in the text of the Geotechnical Report are a part of the earthwork and grading specifications and shall supersede the provisions contained hereinafter in the case of conflict.
- 1.2 Prior to the commencement of grading, a geotechnical consultant (Consultant) shall be employed for the purpose of observing earthwork procedures and testing the fills for substantial conformance with the recommendations of the Geotechnical Report and these specifications. The Consultant should provide adequate testing and observation services so that they may assess whether, in their opinion, the work was performed in substantial conformance with these specifications. It shall be the responsibility of the Contractor to assist the Consultant and keep them apprised of work schedules and changes so that personnel may be scheduled accordingly.
- 1.3 It shall be the sole responsibility of the Contractor to provide adequate equipment and methods to accomplish the work in accordance with applicable grading codes or agency ordinances, these specifications and the approved grading plans. If, in the opinion of the Consultant, unsatisfactory conditions such as questionable soil materials, poor moisture condition, inadequate compaction, and/or adverse weather result in a quality of work not in conformance with these specifications, the Consultant will be empowered to reject the work and recommend to the Owner that grading be stopped until the unacceptable conditions are corrected.

2. DEFINITIONS

- 2.1 **Owner** shall refer to the owner of the property or the entity on whose behalf the grading work is being performed and who has contracted with the Contractor to have grading performed.
- 2.2 **Contractor** shall refer to the Contractor performing the site grading work.
- 2.3 **Civil Engineer** or **Engineer of Work** shall refer to the California licensed Civil Engineer or consulting firm responsible for preparation of the grading plans, surveying and verifying as-graded topography.
- 2.4 **Consultant** shall refer to the soil engineering and engineering geology consulting firm retained to provide geotechnical services for the project.

- 2.5 **Soil Engineer** shall refer to a California licensed Civil Engineer retained by the Owner, who is experienced in the practice of geotechnical engineering. The Soil Engineer shall be responsible for having qualified representatives on-site to observe and test the Contractor's work for conformance with these specifications.
- 2.6 **Engineering Geologist** shall refer to a California licensed Engineering Geologist retained by the Owner to provide geologic observations and recommendations during the site grading.
- 2.7 **Geotechnical Report** shall refer to a soil report (including all addenda) which may include a geologic reconnaissance or geologic investigation that was prepared specifically for the development of the project for which these Recommended Grading Specifications are intended to apply.

3. MATERIALS

- 3.1 Materials for compacted fill shall consist of any soil excavated from the cut areas or imported to the site that, in the opinion of the Consultant, is suitable for use in construction of fills. In general, fill materials can be classified as *soil* fills, *soil-rock* fills or *rock* fills, as defined below.
- 3.1.1 **Soil fills** are defined as fills containing no rocks or hard lumps greater than 12 inches in maximum dimension and containing at least 40 percent by weight of material smaller than $\frac{3}{4}$ inch in size.
- 3.1.2 **Soil-rock fills** are defined as fills containing no rocks or hard lumps larger than 4 feet in maximum dimension and containing a sufficient matrix of soil fill to allow for proper compaction of soil fill around the rock fragments or hard lumps as specified in Paragraph 6.2. **Oversize rock** is defined as material greater than 12 inches.
- 3.1.3 **Rock fills** are defined as fills containing no rocks or hard lumps larger than 3 feet in maximum dimension and containing little or no fines. Fines are defined as material smaller than $\frac{3}{4}$ inch in maximum dimension. The quantity of fines shall be less than approximately 20 percent of the rock fill quantity.
- 3.2 Material of a perishable, spongy, or otherwise unsuitable nature as determined by the Consultant shall not be used in fills.
- 3.3 Materials used for fill, either imported or on-site, shall not contain hazardous materials as defined by the California Code of Regulations, Title 22, Division 4, Chapter 30, Articles 9

and 10; 40CFR; and any other applicable local, state or federal laws. The Consultant shall not be responsible for the identification or analysis of the potential presence of hazardous materials. However, if observations, odors or soil discoloration cause Consultant to suspect the presence of hazardous materials, the Consultant may request from the Owner the termination of grading operations within the affected area. Prior to resuming grading operations, the Owner shall provide a written report to the Consultant indicating that the suspected materials are not hazardous as defined by applicable laws and regulations.

- 3.4 The outer 15 feet of *soil-rock* fill slopes, measured horizontally, should be composed of properly compacted *soil* fill materials approved by the Consultant. *Rock* fill may extend to the slope face, provided that the slope is not steeper than 2:1 (horizontal:vertical) and a soil layer no thicker than 12 inches is track-walked onto the face for landscaping purposes. This procedure may be utilized provided it is acceptable to the governing agency, Owner and Consultant.
- 3.5 Samples of soil materials to be used for fill should be tested in the laboratory by the Consultant to determine the maximum density, optimum moisture content, and, where appropriate, shear strength, expansion, and gradation characteristics of the soil.
- 3.6 During grading, soil or groundwater conditions other than those identified in the Geotechnical Report may be encountered by the Contractor. The Consultant shall be notified immediately to evaluate the significance of the unanticipated condition.

4. CLEARING AND PREPARING AREAS TO BE FILLED

- 4.1 Areas to be excavated and filled shall be cleared and grubbed. Clearing shall consist of complete removal above the ground surface of trees, stumps, brush, vegetation, man-made structures, and similar debris. Grubbing shall consist of removal of stumps, roots, buried logs and other unsuitable material and shall be performed in areas to be graded. Roots and other projections exceeding 1½ inches in diameter shall be removed to a depth of 3 feet below the surface of the ground. Borrow areas shall be grubbed to the extent necessary to provide suitable fill materials.
- 4.2 Asphalt pavement material removed during clearing operations should be properly disposed at an approved off-site facility or in an acceptable area of the project evaluated by Geocon and the property owner. Concrete fragments that are free of reinforcing steel may be placed in fills, provided they are placed in accordance with Section 6.2 or 6.3 of this document.

- 4.3 After clearing and grubbing of organic matter and other unsuitable material, loose or porous soils shall be removed to the depth recommended in the Geotechnical Report. The depth of removal and compaction should be observed and approved by a representative of the Consultant. The exposed surface shall then be plowed or scarified to a minimum depth of 6 inches and until the surface is free from uneven features that would tend to prevent uniform compaction by the equipment to be used.
- 4.4 Where the slope ratio of the original ground is steeper than 5:1 (horizontal:vertical), or where recommended by the Consultant, the original ground should be benched in accordance with the following illustration.

TYPICAL BENCHING DETAIL

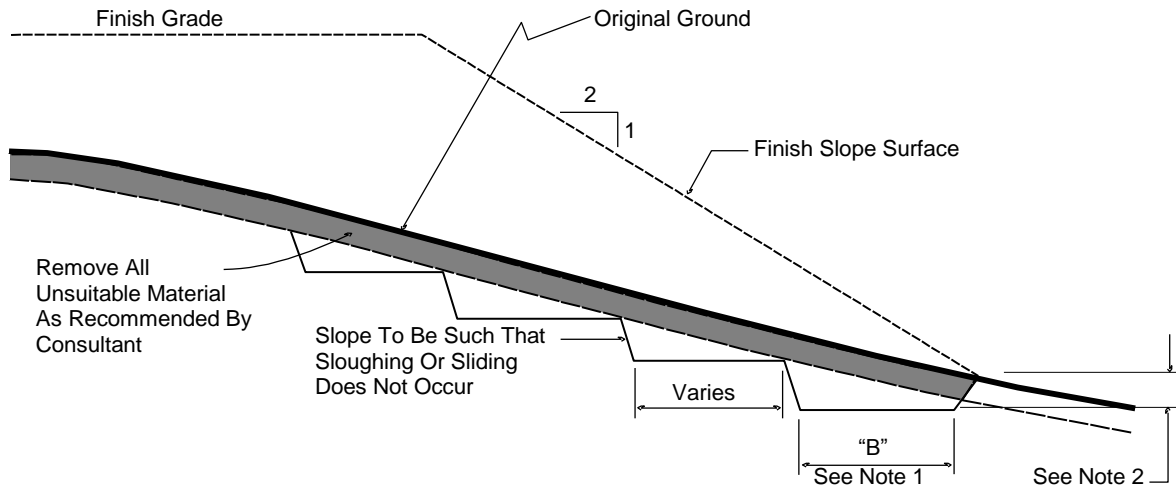

No Scale

- DETAIL NOTES:
- (1) Key width "B" should be a minimum of 10 feet, or sufficiently wide to permit complete coverage with the compaction equipment used. The base of the key should be graded horizontal, or inclined slightly into the natural slope.
 - (2) The outside of the key should be below the topsoil or unsuitable surficial material and at least 2 feet into dense formational material. Where hard rock is exposed in the bottom of the key, the depth and configuration of the key may be modified as approved by the Consultant.

- 4.5 After areas to receive fill have been cleared and scarified, the surface should be moisture conditioned to achieve the proper moisture content, and compacted as recommended in Section 6 of these specifications.

5. COMPACTION EQUIPMENT

- 5.1 Compaction of *soil* or *soil-rock* fill shall be accomplished by sheepsfoot or segmented-steel wheeled rollers, vibratory rollers, multiple-wheel pneumatic-tired rollers, or other types of acceptable compaction equipment. Equipment shall be of such a design that it will be capable of compacting the *soil* or *soil-rock* fill to the specified relative compaction at the specified moisture content.
- 5.2 Compaction of *rock* fills shall be performed in accordance with Section 6.3.

6. PLACING, SPREADING AND COMPACTION OF FILL MATERIAL

- 6.1 *Soil* fill, as defined in Paragraph 3.1.1, shall be placed by the Contractor in accordance with the following recommendations:
- 6.1.1 *Soil* fill shall be placed by the Contractor in layers that, when compacted, should generally not exceed 8 inches. Each layer shall be spread evenly and shall be thoroughly mixed during spreading to obtain uniformity of material and moisture in each layer. The entire fill shall be constructed as a unit in nearly level lifts. Rock materials greater than 12 inches in maximum dimension shall be placed in accordance with Section 6.2 or 6.3 of these specifications.
- 6.1.2 In general, the *soil* fill shall be compacted at a moisture content at or above the optimum moisture content as determined by ASTM D 1557.
- 6.1.3 When the moisture content of *soil* fill is below that specified by the Consultant, water shall be added by the Contractor until the moisture content is in the range specified.
- 6.1.4 When the moisture content of the *soil* fill is above the range specified by the Consultant or too wet to achieve proper compaction, the *soil* fill shall be aerated by the Contractor by blading/mixing, or other satisfactory methods until the moisture content is within the range specified.
- 6.1.5 After each layer has been placed, mixed, and spread evenly, it shall be thoroughly compacted by the Contractor to a relative compaction of at least 90 percent. Relative compaction is defined as the ratio (expressed in percent) of the in-place dry density of the compacted fill to the maximum laboratory dry density as determined in accordance with ASTM D 1557. Compaction shall be continuous over the entire area, and compaction equipment shall make sufficient passes so that the specified minimum relative compaction has been achieved throughout the entire fill.

- 6.1.6 Where practical, soils having an Expansion Index greater than 50 should be placed at least 3 feet below finish pad grade and should be compacted at a moisture content generally 2 to 4 percent greater than the optimum moisture content for the material.
 - 6.1.7 Properly compacted *soil* fill shall extend to the design surface of fill slopes. To achieve proper compaction, it is recommended that fill slopes be over-built by at least 3 feet and then cut to the design grade. This procedure is considered preferable to track-walking of slopes, as described in the following paragraph.
 - 6.1.8 As an alternative to over-building of slopes, slope faces may be back-rolled with a heavy-duty loaded sheepsfoot or vibratory roller at maximum 4-foot fill height intervals. Upon completion, slopes should then be track-walked with a D-8 dozer or similar equipment, such that a dozer track covers all slope surfaces at least twice.
- 6.2 *Soil-rock* fill, as defined in Paragraph 3.1.2, shall be placed by the Contractor in accordance with the following recommendations:
- 6.2.1 Rocks larger than 12 inches but less than 4 feet in maximum dimension may be incorporated into the compacted *soil* fill, but shall be limited to the area measured 15 feet minimum horizontally from the slope face and 5 feet below finish grade or 3 feet below the deepest utility, whichever is deeper.
 - 6.2.2 Rocks or rock fragments up to 4 feet in maximum dimension may either be individually placed or placed in windrows. Under certain conditions, rocks or rock fragments up to 10 feet in maximum dimension may be placed using similar methods. The acceptability of placing rock materials greater than 4 feet in maximum dimension shall be evaluated during grading as specific cases arise and shall be approved by the Consultant prior to placement.
 - 6.2.3 For individual placement, sufficient space shall be provided between rocks to allow for passage of compaction equipment.
 - 6.2.4 For windrow placement, the rocks should be placed in trenches excavated in properly compacted *soil* fill. Trenches should be approximately 5 feet wide and 4 feet deep in maximum dimension. The voids around and beneath rocks should be filled with approved granular soil having a Sand Equivalent of 30 or greater and should be compacted by flooding. Windrows may also be placed utilizing an "open-face" method in lieu of the trench procedure, however, this method should first be approved by the Consultant.

- 6.2.5 Windrows should generally be parallel to each other and may be placed either parallel to or perpendicular to the face of the slope depending on the site geometry. The minimum horizontal spacing for windrows shall be 12 feet center-to-center with a 5-foot stagger or offset from lower courses to next overlying course. The minimum vertical spacing between windrow courses shall be 2 feet from the top of a lower windrow to the bottom of the next higher windrow.
- 6.2.6 Rock placement, fill placement and flooding of approved granular soil in the windrows should be continuously observed by the Consultant.
- 6.3 *Rock* fills, as defined in Section 3.1.3, shall be placed by the Contractor in accordance with the following recommendations:
- 6.3.1 The base of the *rock* fill shall be placed on a sloping surface (minimum slope of 2 percent). The surface shall slope toward suitable subdrainage outlet facilities. The *rock* fills shall be provided with subdrains during construction so that a hydrostatic pressure buildup does not develop. The subdrains shall be permanently connected to controlled drainage facilities to control post-construction infiltration of water.
- 6.3.2 *Rock* fills shall be placed in lifts not exceeding 3 feet. Placement shall be by rock trucks traversing previously placed lifts and dumping at the edge of the currently placed lift. Spreading of the *rock* fill shall be by dozer to facilitate *seating* of the rock. The *rock* fill shall be watered heavily during placement. Watering shall consist of water trucks traversing in front of the current rock lift face and spraying water continuously during rock placement. Compaction equipment with compactive energy comparable to or greater than that of a 20-ton steel vibratory roller or other compaction equipment providing suitable energy to achieve the required compaction or deflection as recommended in Paragraph 6.3.3 shall be utilized. The number of passes to be made should be determined as described in Paragraph 6.3.3. Once a *rock* fill lift has been covered with *soil* fill, no additional *rock* fill lifts will be permitted over the *soil* fill.
- 6.3.3 Plate bearing tests, in accordance with ASTM D 1196, may be performed in both the compacted *soil* fill and in the *rock* fill to aid in determining the required minimum number of passes of the compaction equipment. If performed, a minimum of three plate bearing tests should be performed in the properly compacted *soil* fill (minimum relative compaction of 90 percent). Plate bearing tests shall then be performed on areas of *rock* fill having two passes, four passes and six passes of the compaction equipment, respectively. The number of passes required for the *rock* fill shall be determined by comparing the results of the plate bearing tests for the *soil* fill and the *rock* fill and by evaluating the deflection

variation with number of passes. The required number of passes of the compaction equipment will be performed as necessary until the plate bearing deflections are equal to or less than that determined for the properly compacted *soil* fill. In no case will the required number of passes be less than two.

- 6.3.4 A representative of the Consultant should be present during *rock* fill operations to observe that the minimum number of “passes” have been obtained, that water is being properly applied and that specified procedures are being followed. The actual number of plate bearing tests will be determined by the Consultant during grading.
- 6.3.5 Test pits shall be excavated by the Contractor so that the Consultant can state that, in their opinion, sufficient water is present and that voids between large rocks are properly filled with smaller rock material. In-place density testing will not be required in the *rock* fills.
- 6.3.6 To reduce the potential for “piping” of fines into the *rock* fill from overlying *soil* fill material, a 2-foot layer of graded filter material shall be placed above the uppermost lift of *rock* fill. The need to place graded filter material below the *rock* should be determined by the Consultant prior to commencing grading. The gradation of the graded filter material will be determined at the time the *rock* fill is being excavated. Materials typical of the *rock* fill should be submitted to the Consultant in a timely manner, to allow design of the graded filter prior to the commencement of *rock* fill placement.
- 6.3.7 *Rock* fill placement should be continuously observed during placement by the Consultant.

7. SUBDRAINS

- 7.1 The geologic units on the site may have permeability characteristics and/or fracture systems that could be susceptible under certain conditions to seepage. The use of canyon subdrains may be necessary to mitigate the potential for adverse impacts associated with seepage conditions. Canyon subdrains with lengths in excess of 500 feet or extensions of existing offsite subdrains should use 8-inch-diameter pipes. Canyon subdrains less than 500 feet in length should use 6-inch-diameter pipes.

TYPICAL CANYON DRAIN DETAIL

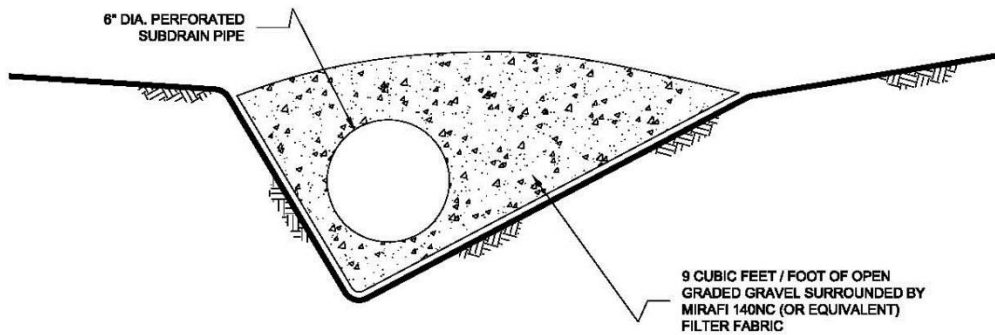
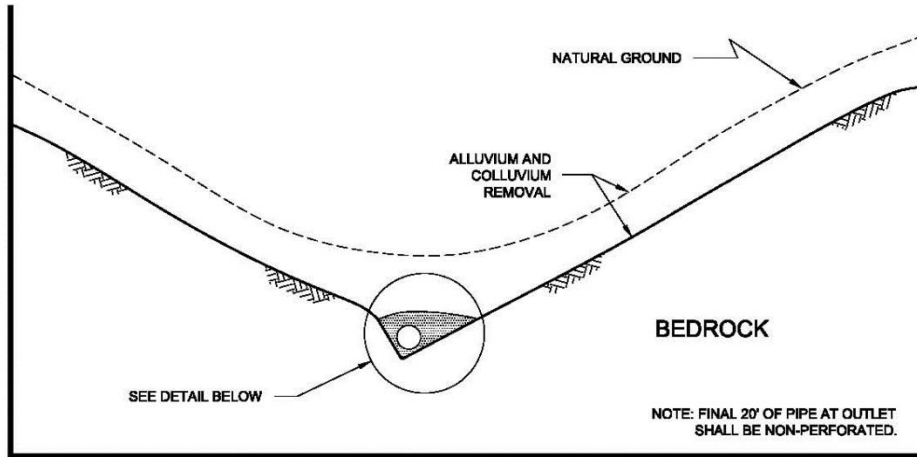

NOTES:

- 1.....8-INCH DIAMETER, SCHEDULE 80 PVC PERFORATED PIPE FOR FILLS IN EXCESS OF 100-FEET IN DEPTH OR A PIPE LENGTH OF LONGER THAN 500 FEET.
- 2.....6-INCH DIAMETER, SCHEDULE 40 PVC PERFORATED PIPE FOR FILLS LESS THAN 100-FEET IN DEPTH OR A PIPE LENGTH SHORTER THAN 500 FEET.

NO SCALE

7.2 Slope drains within stability fill keyways should use 4-inch-diameter (or larger) pipes.

TYPICAL STABILITY FILL DETAIL

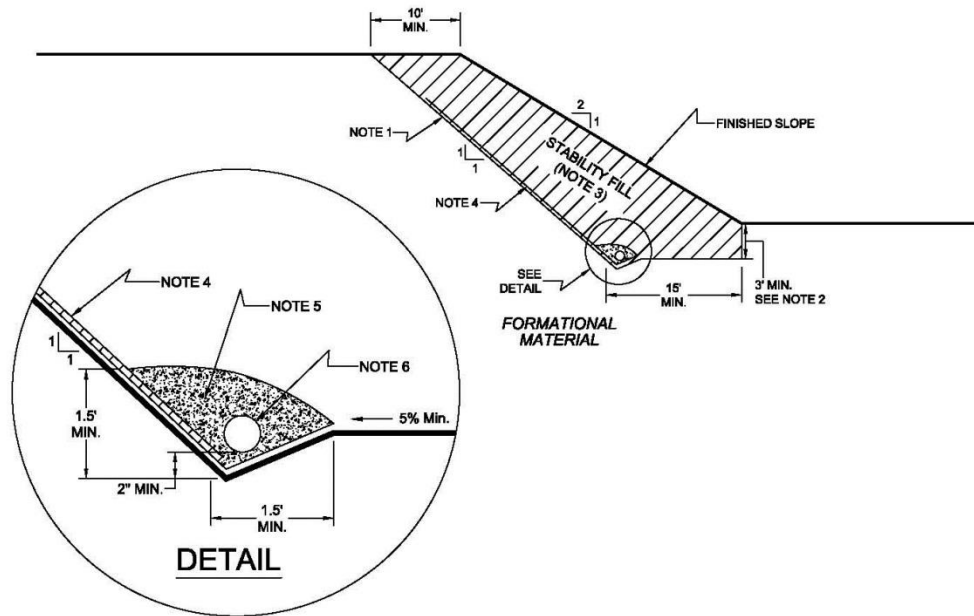

NOTES:

- 1.....EXCAVATE BACKCUT AT 1:1 INCLINATION (UNLESS OTHERWISE NOTED).
- 2.....BASE OF STABILITY FILL TO BE 3 FEET INTO FORMATIONAL MATERIAL, SLOPING A MINIMUM 5% INTO SLOPE.
- 3.....STABILITY FILL TO BE COMPOSED OF PROPERLY COMPACTED GRANULAR SOIL.
- 4.....CHIMNEY DRAINS TO BE APPROVED PREFABRICATED CHIMNEY DRAIN PANELS (MIRADRAIN G200N OR EQUIVALENT) SPACED APPROXIMATELY 20 FEET CENTER TO CENTER AND 4 FEET WIDE. CLOSER SPACING MAY BE REQUIRED IF SEEPAGE IS ENCOUNTERED.
- 5.....FILTER MATERIAL TO BE 3/4-INCH, OPEN-GRADED CRUSHED ROCK ENCLOSED IN APPROVED FILTER FABRIC (MIRAFI 140NC).
- 6.....COLLECTOR PIPE TO BE 4-INCH MINIMUM DIAMETER, PERFORATED, THICK-WALLED PVC SCHEDULE 40 OR EQUIVALENT, AND SLOPED TO DRAIN AT 1 PERCENT MINIMUM TO APPROVED OUTLET.

NO SCALE

7.3 The actual subdrain locations will be evaluated in the field during the remedial grading operations. Additional drains may be necessary depending on the conditions observed and the requirements of the local regulatory agencies. Appropriate subdrain outlets should be evaluated prior to finalizing 40-scale grading plans.

7.4 *Rock fill or soil-rock fill* areas may require subdrains along their down-slope perimeters to mitigate the potential for buildup of water from construction or landscape irrigation. The subdrains should be at least 6-inch-diameter pipes encapsulated in gravel and filter fabric. *Rock fill* drains should be constructed using the same requirements as canyon subdrains.

7.5 Prior to outletting, the final 20-foot segment of a subdrain that will not be extended during future development should consist of non-perforated drainpipe. At the non-perforated/perforated interface, a seepage cutoff wall should be constructed on the downslope side of the pipe.

TYPICAL CUT OFF WALL DETAIL

FRONT VIEW

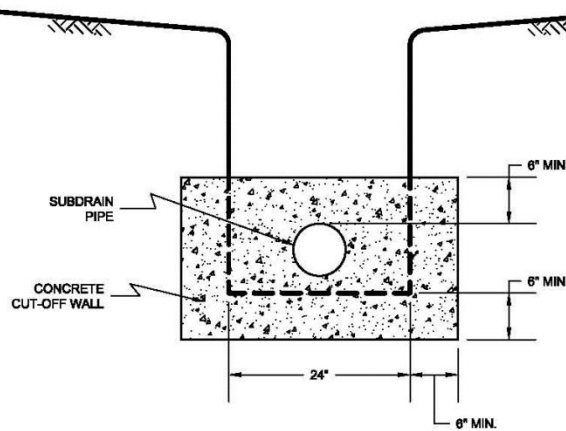

NO SCALE

SIDE VIEW

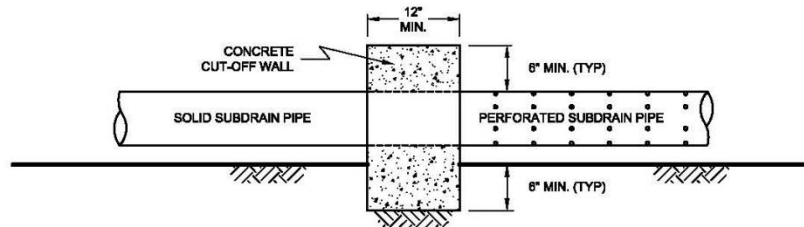

NO SCALE

7.6 Subdrains that discharge into a natural drainage course or open space area should be provided with a permanent headwall structure.

TYPICAL HEADWALL DETAIL

FRONT VIEW

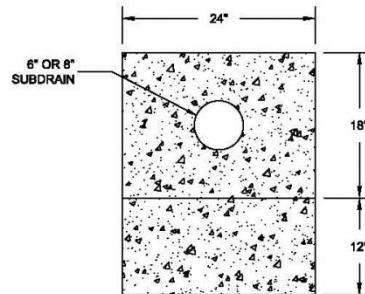

NO SCALE

SIDE VIEW

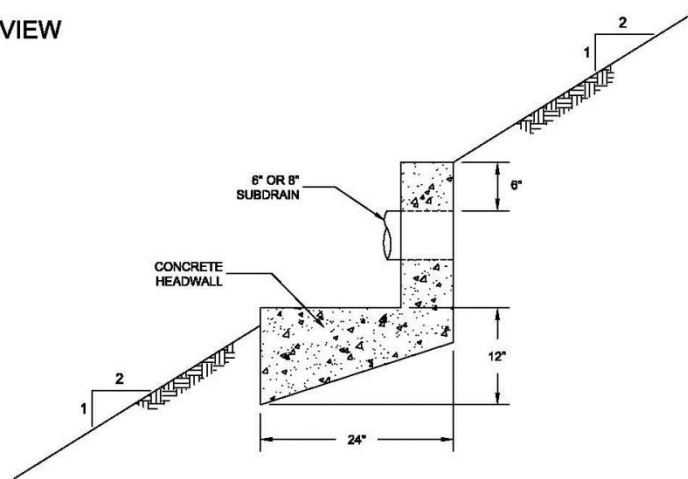

NOTE: HEADWALL SHOULD OUTLET AT TOE OF FILL SLOPE
OR INTO CONTROLLED SURFACE DRAINAGE

NO SCALE

- 7.7 The final grading plans should show the location of the proposed subdrains. After completion of remedial excavations and subdrain installation, the project civil engineer should survey the drain locations and prepare an “as-built” map showing the drain locations. The final outlet and connection locations should be determined during grading operations. Subdrains that will be extended on adjacent projects after grading can be placed on formational material and a vertical riser should be placed at the end of the subdrain. The grading contractor should consider videoing the subdrains shortly after burial to check proper installation and functionality. The contractor is responsible for the performance of the drains.

8. OBSERVATION AND TESTING

- 8.1 The Consultant shall be the Owner's representative to observe and perform tests during clearing, grubbing, filling, and compaction operations. In general, no more than 2 feet in vertical elevation of *soil* or *soil-rock* fill should be placed without at least one field density test being performed within that interval. In addition, a minimum of one field density test should be performed for every 2,000 cubic yards of *soil* or *soil-rock* fill placed and compacted.
- 8.2 The Consultant should perform a sufficient distribution of field density tests of the compacted *soil* or *soil-rock* fill to provide a basis for expressing an opinion whether the fill material is compacted as specified. Density tests shall be performed in the compacted materials below any disturbed surface. When these tests indicate that the density of any layer of fill or portion thereof is below that specified, the particular layer or areas represented by the test shall be reworked until the specified density has been achieved.
- 8.3 During placement of *rock* fill, the Consultant should observe that the minimum number of passes have been obtained per the criteria discussed in Section 6.3.3. The Consultant should request the excavation of observation pits and may perform plate bearing tests on the placed *rock* fills. The observation pits will be excavated to provide a basis for expressing an opinion as to whether the *rock* fill is properly seated and sufficient moisture has been applied to the material. When observations indicate that a layer of *rock* fill or any portion thereof is below that specified, the affected layer or area shall be reworked until the *rock* fill has been adequately seated and sufficient moisture applied.
- 8.4 A settlement monitoring program designed by the Consultant may be conducted in areas of *rock* fill placement. The specific design of the monitoring program shall be as recommended in the Conclusions and Recommendations section of the project Geotechnical Report or in the final report of testing and observation services performed during grading.
- 8.5 We should observe the placement of subdrains, to check that the drainage devices have been placed and constructed in substantial conformance with project specifications.
- 8.6 Testing procedures shall conform to the following Standards as appropriate:

8.6.1 Soil and Soil-Rock Fills:

- 8.6.1.1 Field Density Test, ASTM D 1556, *Density of Soil In-Place By the Sand-Cone Method.*

- 8.6.1.2 Field Density Test, Nuclear Method, ASTM D 6938, *Density of Soil and Soil-Aggregate In-Place by Nuclear Methods (Shallow Depth)*.
- 8.6.1.3 Laboratory Compaction Test, ASTM D 1557, *Moisture-Density Relations of Soils and Soil-Aggregate Mixtures Using 10-Pound Hammer and 18-Inch Drop*.
- 8.6.1.4 Expansion Index Test, ASTM D 4829, *Expansion Index Test*.

9. PROTECTION OF WORK

- 9.1 During construction, the Contractor shall properly grade all excavated surfaces to provide positive drainage and prevent ponding of water. Drainage of surface water shall be controlled to avoid damage to adjoining properties or to finished work on the site. The Contractor shall take remedial measures to prevent erosion of freshly graded areas until such time as permanent drainage and erosion control features have been installed. Areas subjected to erosion or sedimentation shall be properly prepared in accordance with the Specifications prior to placing additional fill or structures.
- 9.2 After completion of grading as observed and tested by the Consultant, no further excavation or filling shall be conducted except in conjunction with the services of the Consultant.

10. CERTIFICATIONS AND FINAL REPORTS

- 10.1 Upon completion of the work, Contractor shall furnish Owner a certification by the Civil Engineer stating that the lots and/or building pads are graded to within 0.1 foot vertically of elevations shown on the grading plan and that all tops and toes of slopes are within 0.5 foot horizontally of the positions shown on the grading plans. After installation of a section of subdrain, the project Civil Engineer should survey its location and prepare an *as-built* plan of the subdrain location. The project Civil Engineer should verify the proper outlet for the subdrains and the Contractor should ensure that the drain system is free of obstructions.
- 10.2 The Owner is responsible for furnishing a final as-graded soil and geologic report satisfactory to the appropriate governing or accepting agencies. The as-graded report should be prepared and signed by a California licensed Civil Engineer experienced in geotechnical engineering and by a California Certified Engineering Geologist, indicating that the geotechnical aspects of the grading were performed in substantial conformance with the Specifications or approved changes to the Specifications.

LIST OF REFERENCES

1. City of San Diego (2008), Seismic Safety Study, Geologic Hazards and Faults, Grid Tile 6, dated April 3, 2008;
2. FEMA (2012), *Flood Map Service Center*, FEMA website, <https://msc.fema.gov/portal/home>, flood map number 06073C2159G, effective May 16, 2012, accessed January 15, 2020;
3. Geocon Incorporated, *Geotechnical Investigation, Nakano Property, Dennery Ranch Area, Chula Vista, California*, dated May 10, 2005 (Project No. 07516-42-01).
4. Jennings, C. W., 1994, California Division of Mines and Geology, *Fault Activity Map of California and Adjacent Areas*, California Geologic Data Map Series Map No. 6.
5. Kennedy, M. P., and S. S. Tan, 2005, *Geologic Map of the San Diego 30'x60' Quadrangle, California*, USGS Regional Map Series Map No. 3, Scale 1:100,000.
6. SEAOC (2019), *OSHPD Seismic Design Maps: Structural Engineers Association of California* website, <http://seismicmaps.org/>, accessed December 10, 2018;
7. USGS (2019), *Quaternary Fault and Fold Database of the United States: U.S. Geological Survey* website, <https://www.usgs.gov/natural-hazards/earthquake-hazards/faults>, accessed January 14, 2020;
8. Unpublished reports and maps on file with Geocon Incorporated.